

FM 3-04.126
February 2007

Attack Reconnaissance Helicopter Operations

DISTRIBUTION RESTRICTION: Approved for public release; distribution is unlimited.

Headquarters, Department of the Army

Attack Reconnaissance Helicopter Operations

Contents

	Page
Preface	vii
Chapter 1 Missions and Organization.....	1-1
Section I – Overview.....	1-1
Combined Arms.....	1-1
Fundamentals.....	1-2
Section II – Missions.....	1-4
Attack Reconnaissance Battalion.....	1-4
Air Cavalry Squadron	1-4
Section III – Organization	1-5
Attack Reconnaissance Battalion.....	1-5
Air Cavalry Squadron	1-9
Chapter 2 Command and Control.....	2-1
Section I – Command and Control	2-1
Command	2-1
Control	2-1
Command and Control Systems	2-2
Communications.....	2-2
Battalion Communication Nets	2-3
Section II – Battalion Command and Control	2-5
Battalion Command Group.....	2-5
Tactical Command Post	2-14
Main Command Post.....	2-15
Battalion Planning Considerations	2-21
Section III – Company Command and Control.....	2-26
Company Command Post	2-26
Company Planning Considerations	2-30
Section IV – Meetings and Briefings	2-34
Operations Order Brief	2-34
Air Mission Brief.....	2-34
Team Brief	2-35
Crew Mission Brief.....	2-35
Section V – Rehearsals.....	2-35
Rehearsal Sequence and Attendance	2-36
Rehearsal Question Resolution.....	2-37
Conflict Resolution at the Rehearsal	2-38

Distribution Restriction: Approved for public release; distribution is unlimited.

***This publication supersedes FM 1-112, 2 April 1997, and FM 1-114, 1 February 2000.**

	Additional Rehearsals	2-38
	Rehearsal Completion	2-38
	Section VI – End of Mission Debriefing and After-Action Review	2-38
	Debriefs	2-38
	After-Action Review	2-40
Chapter 3	Employment.....	3-1
	Section I – Introduction	3-1
	Section II – Team Employment.....	3-2
	Scout Weapons Team Employment	3-2
	Flight Modes and Movement Techniques.....	3-6
	Section III — Reconnaissance Operations	3-10
	Fundamentals	3-11
	Planning Considerations	3-13
	Capabilities.....	3-19
	Reconnaissance Methods	3-20
	Forms of Reconnaissance	3-21
	Section IV – Security Operations	3-30
	Fundamentals	3-31
	Planning Considerations	3-33
	Types of Security Operations.....	3-34
	Time and Space Considerations for Reconnaissance and Security Missions	3-54
	Screen Planning Examples (8-12 Hours)	3-54
	Screen Planning Calculations (8-12 Hours)	3-56
	Section V – Attack Operations	3-58
	Attack Forms	3-58
	Attack Missions	3-59
	Attack Employment Methods	3-64
	Engagement Area Development.....	3-71
	Holding Area Operations.....	3-84
	Attack By Fire/Battle Position Operations	3-85
	Section VI – Movement To Contact.....	3-87
	Search and Attack.....	3-87
	Section VII – Personnel Recovery Operations	3-88
	Section VIII - Stability and Civil Support Operations.....	3-95
	Overview	3-95
	Planning Considerations	3-96
	Special Considerations	3-97
	Rules of Engagement	3-98
	Rules of Interaction.....	3-98
	Section iX – Urban Operations	3-98
	Planning Considerations	3-99
	Operational Phases	3-109
	Aircrew Urban Threat Considerations.....	3-111
	Reconnaissance Operations.....	3-112
	Employment of Lasers	3-113
	Section X – Quick Reaction Force Operations	3-114
	Quick Reaction Force	3-114
	Section XI – Passage of Lines and Battle Handover.....	3-116
	Passage of Lines	3-116
	Battle Handover	3-118
	Section XII – Air Combat Operations.....	3-120
	General	3-120

	Planning Considerations	3-120
	Section XIII – Deception Operations	3-120
	Feint.....	3-120
	Demonstration	3-121
Chapter 4	Sustainment Operations.....	4-1
	Section I – Introduction.....	4-1
	Section II – Logistics Fundamentals.....	4-1
	Logistics Characteristics.....	4-1
	Methods of Distribution.....	4-2
	Supply Operations.....	4-2
	Sustainment During Combat Operations	4-5
	Section III – Maintenance.....	4-6
	Principles.....	4-6
	Aviation Maintenance Operations	4-7
	Vehicle and Ground Equipment Maintenance and Recovery Operations	4-11
	Section IV – Battalion Sustainment Units.....	4-11
	Flight Company	4-11
	Aviation Maintenance Company.....	4-12
	Forward Support Company	4-13
	Headquarters and Headquarters Company	4-16
	Aviation Support Battalion	4-17
	Section V – Standard Army Management Information Systems.....	4-20
	Standard Army Maintenance System.....	4-20
	Standard Army Retail Supply System	4-23
	Integrated Logistics Analysis Program.....	4-24
	Defense Automatic Addressing System.....	4-25
	Aviation Life Support System	4-25
Appendix A	Aircraft Survivability	A-1
Appendix B	Army Aviation Air-Ground Integration	B-1
Appendix C	Joint Air Attack Team Operations	C-1
Appendix D	Briefings, Reports, and Formats.....	D-1
Appendix E	Aircraft Characteristics.....	E-1
Appendix F	Reference Library	F-1
Glossary	Glossary-1
References	References-1
Index	Index-1

Figures

Figure 1-1. Attack reconnaissance battalion/attack reconnaissance squadron organization	1-6
Figure 1-2. Attack reconnaissance battalion headquarters and headquarters company organization	1-6
Figure 1-3. Attack reconnaissance battalion/attack reconnaissance squadron staff organization	1-7
Figure 1-4. Attack reconnaissance company/attack reconnaissance troop	1-8
Figure 1-5. Attack reconnaissance battalion forward support company	1-9
Figure 1-6. Attack reconnaissance battalion aviation maintenance company ..	1-10
Figure 1-7. Air cavalry squadron	1-10
Figure 2-1. Military decisionmaking process	2-23
Figure 2-2. Troop leading procedures and key planning tasks	2-31
Figure 3-1. Formation separation	3-4
Figure 3-2. Combat cruise	3-5
Figure 3-3. Combat cruise right (depicted)	3-5
Figure 3-4. Combat spread	3-6
Figure 3-5. Inner/Outer Drill	3-18
Figure 3-6. Example of company route reconnaissance graphics	3-24
Figure 3-7. Example of company zone reconnaissance graphics	3-25
Figure 3-8. Example of company area reconnaissance graphics	3-28
Figure 3-9. Example of landing zone or pickup zone sketch	3-29
Figure 3-10. Screen locations	3-34
Figure 3-11. Stationary screen	3-37
Figure 3-12. Moving flank screen	3-39
Figure 3-13. Moving rear screen	3-40
Figure 3-14. Rear area incursion screen	3-41
Figure 3-15. Stationary flank guard	3-43
Figure 3-16. Moving flank guard	3-45
Figure 3-17. Attack reconnaissance company support of cordon and search ..	3-46
Figure 3-18. Standard convoy security technique	3-48
Figure 3-19. Butterfly pattern convoy security technique	3-49
Figure 3-20. Inverted "Y" aerial escort formation	3-51
Figure 3-21. Air assault planning stages	3-52
Figure 3-22. Attached escort landing zone reconnaissance	3-53
Figure 3-23. Screen with rapid response team	3-55
Figure 3-24. Maximum screen line option	3-56
Figure 3-25. Computing en route time	3-57
Figure 3-26. Computing ground unit movement time	3-57
Figure 3-27. Example of simultaneous and continuous attacks	3-65
Figure 3-28. Example of a 45-degree simultaneous attack	3-66
Figure 3-29. Racetrack pattern	3-67
Figure 3-30. Example of a cloverleaf pattern	3-67
Figure 3-31. Example of an L-attack pattern	3-68
Figure 3-32. Example of a static attack pattern	3-69
Figure 3-33. Low-level attack	3-70
Figure 3-34. Bump attack	3-70
Figure 3-35. High attack	3-71
Figure 3-36. Engagement area development steps one and two	3-73
Figure 3-37. Engagement area development step three (part 1)	3-74
Figure 3-38. Engagement area development step three (part 2)	3-74
Figure 3-39. Engagement area development step three (part 3)	3-75
Figure 3-40. Techniques of fire distribution	3-77
Figure 3-41. Engagement area development step four (part 1)	3-79

Figure 3-42. Engagement area development step four (part 2)..... 3-80

Figure 3-43. Holding area occupation 3-85

Figure 3-44. Example of a standard set 3-86

Figure 3-45. Example of a nonstandard set 3-86

Figure 3-46. Example of an area sketch 3-101

Figure 3-47. Example of a network “spider web” route structure 3-102

Figure 3-48. Example of running fire technique 3-103

Figure 3-49. Example of hovering fire technique 3-104

Figure 3-50. Example of urban targeting grid system 3-105

Figure 3-51. Example of objective area reference grid system..... 3-105

Figure 3-52. Example of target reference points technique 3-106

Figure 3-53. Example of building numbering convention 3-107

Figure 3-54. Example of floor and window lettering convention 3-108

Figure 4-1. Two-level aviation maintenance and sustainment..... 4-7

Figure 4-2. Aviation support battalion..... 4-18

Figure 4-3. Standard army management information system architecture 4-21

Figure A-1. Roles and functions A-3

Figure A-2. Example aircraft survivability equipment/electronic warfare mission brief format..... A-6

Figure B-1. Mission planning through execution cycle..... B-9

Figure B-2. Fratricide risk factors B-12

Figure B-2. Fratricide risk factors (continued) B-13

Figure B-3. Risk reduction and/or fratricide prevention measures..... B-14

Figure B-4. Maneuver brigade combat teams B-15

Figure C-1. Lateral/geographic separation..... C-9

Figure C-2. Altitude separation..... C-10

Figure C-3. Time separation..... C-11

Figure C-4. CAS check-in briefing..... C-12

Figure C-5. CAS briefing format C-13

Figure C-6. Example of combined attack C-15

Figure C-7. Example of a sectored attack..... C-16

Figure C-8. Night JAAT and associated control measures C-19

Figure E-1. OH-58D weapons loading **Error! Bookmark not defined.**

Tables

Table 1-1. Attack reconnaissance battalion’s role in Army warfighting functions	1-2
Table 2-1. Battalion internal radio networks	2-4
Table 2-2. Battalion external radio networks	2-4
Table 2-3. Example of main command post occupation timeline	2-21
Table 2-4. Munitions selection	2-25
Table 2-5. Example cell assignments matrix	2-32
Table 2-6. Sample mission debrief	2-39
Table 3-1. Team tasks	3-2
Table 3-2. OH-58D/AH-64 Scout weapons team tasks	3-3
Table 3-3. Flank security movement methods.....	3-36
Table 3-4. Example marking techniques for pickup zones	3-52
Table 3-5. Close combat attack checklist for ground commander	3-60
Table 3-6. Attack reconnaissance team response	3-62
Table 3-7. Engagement area checklist	3-76
Table 3-8. Personnel recovery terms.....	3-89
Table 3-9. Types of escort	3-92
Table 3-10. Voice battle handover information.....	3-119
Table 3-11. AH-64D Digital battle handover information	3-119
Table 4-1. Classes of supply.....	4-3
Table B-1. Individual actions on the detect, identify, decide, engage, and assess process.....	B-1
Table B-2. Methods of marking friendly and enemy positions.....	B-5
Table B-3. Brevity list	B-7
Table C-1. Joint air attack planning guideline.....	C-6
Table C-2. Comparison of firepower timing options	C-14
Table C-3. Laser operations example radio calls	C-20
Table D-1. Example for predeployment and pretemporary duty	D-1
Table D-2. Example for convoy precombat inspection	D-2
Table D-3. Example for precombat inspections.....	D-4
Table D-4. Example for personnel recovery planning	D-4
Table D-5. Example for cordon and search.....	D-7
Table D-6. Example rescue mission brief	D-8
Table D-7. Example landing zone survey	D-9
Table D-8. Example spot report.....	D-9
Table D-9. Example convoy status report.....	D-10
Table D-10. Example weather advisory/watch report.....	D-10
Table D-11. Example rail load status report	D-11
Table D-12. Example closure report.....	D-11
Table D-13. Example aircraft slant report.....	D-11
Table D-14. Example personnel daily summary report	D-12
Table D-15. Example meaconing, intrusion, jamming, interference report	D-12
Table D-16. Example medical evacuation nine-line report.....	D-13
Table D-17. Example unexploded ordinance report	D-14
Table D-18. Example of a company warning order	D-14
Table D-19. Example company/troop operation order.....	D-15
Table D-20. Example of flounder report.....	D-18
Table E-1. OH-58D characteristics	E-1
Table E-2. Typical OH-58D helicopter ordnance loads	E-3
Table E-3. Comparison of Apache specifications	E-4
Table E-4. AH-64D characteristics	E-5
Table E-5. AH-64D weapons loads, weights, and radius	E-7
Table E-6. Armed reconnaissance helicopter characteristics	E-8

Preface

Field manual (FM) 3-04.126, is intended for use by commanders, staffs, and United States military personnel expecting to operate and employ Army aviation attack reconnaissance units.

This FM is the Army's doctrine for how to fight and sustain attack reconnaissance helicopter battalions, squadrons, companies and troops. The operational concepts described in this manual are based on Army doctrine as established in FM 1, FM 3-0, and FM 3-04.111. Emphasis is placed on modular force structure and the enhanced operational capability provided by Army aviation transformation.

FM 3-04.126 applies to the Active Army, the Army National Guard/Army National Guard of the United States, the United States Army Reserve, and Army civilian employees across the spectrum of conflict, unless otherwise stated. It builds on collective knowledge and experience gained through recent operations, numerous exercises, and the deliberate process of informed reasoning. This publication is rooted in time-tested principles and fundamentals, while accommodating new technologies, and evolving responses to the diverse threats to our national security. This manual will also assist Army proponent schools in teaching attack reconnaissance helicopter operations.

FM 3-04.126 describes attack reconnaissance organizations, missions, command and control (C2), tactical employment and sustainment. It describes the responsibilities and duties of essential personnel during training, operations and combat. This manual is authoritative but not considered inflexible. Each situation in combat must be resolved by an intelligent interpretation and application of the doctrine set forth herein. Standardized battalion, squadron, company and troop operations are necessary for the effective employment of aviation battalion task forces. To this end, like companies and troops should follow similar operational and employment procedures. Appendixes A through D provide supplemental information on aircraft survivability, Army aviation air-ground integration, joint air attack team operations, and aircraft characteristics. A reference library is provided in Appendix E.

FM 3-04.126 furnishes a foundation for attack reconnaissance helicopter doctrine, force design, materiel acquisition, professional education, and individual and unit training.

The proponent of this publication is Headquarters, United States Army Training and Doctrine Command (TRADOC). Send comments and recommendations on Department of the Army (DA) Form 2028 (Recommended Changes to publications and Blank Forms) or automated link (<http://www.usapa.army.mil/da2028/daform2028.asp>) to Commander, United States Army Aviation Warfighting Center (USAAWC), ATTN: ATZQ-TD-D, Fort Rucker, Alabama 36362-5263. Comments may be e-mailed to the Directorate of Training and Doctrine (DOTD) at av.doctrine@us.army.mil. Other doctrinal information can be found on the Internet at Army Knowledge Online (AKO) or call defense switch network (DSN) 558-3551 or (334) 255-3551.

Unless this publication states otherwise, masculine nouns and pronouns do not refer exclusively to men.

This publication has been reviewed for operations security considerations.

Chapter 1

Missions and Organization

The attack reconnaissance battalion (ARB) and attack reconnaissance squadron (ARS) are organized and equipped to support joint, interagency, multinational and Army operations. These units conduct continuous combat operations throughout the depth and breadth of the operational environment. Although their organization and missions differ by parent division, their principal focus is similar. Each unit focuses on time-tested fundamentals to achieve success. This chapter discusses these fundamentals and outlines basic organization, principal mission focus, and capabilities of the ARB. The organization description for each unit is based on the official table of organization and equipment (TOE). Operationally, all units are resourced according to the modified table of organization and equipment (MTOE), so actual organizations may look different from the TOEs described in this FM.

Note: Throughout this manual, for readability, the term company includes troop, and battalion includes squadron. The terms troop and squadron may be used when specifically discussing air cavalry squadrons (ACs) or their respective subordinate units.

SECTION I – OVERVIEW

COMBINED ARMS

1-1. Combined arms is the synchronized and simultaneous application of the warfighting functions (WFFs) to achieve an effect that is greater than if each arm were used in sequence. It is the full integration of different capabilities in such a way that, to counteract one, the enemy must become more vulnerable to another. Combined arms employ all the WFFs and their supporting systems. Combined arms multiply the effectiveness of Army forces in all operations.

Contents	
Section I – Overview	1-1
Section II – Missions	1-4
Section III – Organization	1-5

1-2. Employing combined arms is simple in concept. However, it requires highly trained Soldiers, skilled leadership, effective staff work, and integrated information systems. Combined arms operations must be synchronized so the effects of combat power occur simultaneously. *Synchronization* is the arrangement of military actions in time, space, and purpose to produce maximum relative combat power at a decisive place and time. (FM 1-02) Through synchronization, commanders arrange WFFs to mass the effects of combat power at the chosen place and time to overwhelm an enemy or dominate the situation.

1-3. Combined arms are achieved through organizational design (standing organizations) and temporary reorganization (tailored and task-organized units). For example, units organic to brigade combat teams (BCTs) perform all WFFs. However, the BCT does not organically include Army aviation. When required, the capabilities are added through tailoring and task-organizing, temporarily subordinating elements of different units under one commander.

1-4. Aviation battalions plan, coordinate, and execute operations. They create opportunities for commanders to disrupt the enemy's decision-making process, forcing them to make decisions that disrupt

initial plans. The battalion—through coordination, liaison, C2, situational awareness (SA), and situational understanding (SU)—helps set conditions for the force's success.

1-5. The ARB conducts full spectrum operations (FM 3-90) in support of their higher headquarters. The ARB supports offensive and defensive operations (reconnaissance, security, and attack) against armored or mechanized equipped threat forces, and against lighter equipped or insurgent forces. The ARB is less suited for stability and civil support operations based on organization, but can support these operations by providing security (area, route, and convoy) and quick reaction force (QRF) capability and reconnaissance through the supported unit's intelligence, surveillance, and reconnaissance (ISR) operations.

FUNDAMENTALS

- 1-6. All battalions should be able to—
- Plan and conduct strategic deployment.
 - Conduct administrative and tactical movements.
 - Coordinate with supported maneuver units.
 - Develop and maintain intelligence preparation of the battlefield (IPB).
 - Use the full spectrum of communications means to satisfy internal and external requirements for combat information.
 - Act as a battalion task force (TF) headquarters.
 - Conduct multiple simultaneous operations.
 - Plan multiple future operations.
 - Conduct liaison with adjacent and supported units.
 - Protect and sustain their forces.
 - Conduct air-ground intergration.

ARMY WARFIGHTING FUNCTIONS

1-7. Battalion commanders and staffs must be fully aware of the six Army WFFs (see field manual interim [FMI] 5-0.1). Table 1-1 gives examples of tasks the ARB may perform in support of each WFF.

Table 1-1. Attack reconnaissance battalion's role in Army warfighting functions

Army Warfighting Function	ARB's Role
Movement & Maneuver	<ul style="list-style-type: none"> ● Engage enemy forces decisively through attack operations. ● Shape the operational environment through aggressive IAs, reconnaissance, and security operations.
Intelligence	<ul style="list-style-type: none"> ● Assist commander and staff in conducting IPB. ● Provide higher headquarters SA. ● Confirm or deny elements of the ISR plan and priority intelligence requirements. ● Conduct reconnaissance to allow commander to make informed decisions, delegate authority, and synchronize the WFFs. ● Conduct reconnaissance to find bypasses, adequate sites and routes, and provide overwatch for ground operations.
Fire Support (FS)	<ul style="list-style-type: none"> ● Designate for laser-guided artillery or other service munitions. ● Conduct counterbattery fires to find and target enemy mortars and artillery. ● Synchronize indirect fires to delay, disrupt, or destroy enemy forces, systems, and facilities.
Sustainment	<ul style="list-style-type: none"> ● Generate combat power in support of ground operations. ● Perform reconnaissance to identify routes and provide pickup zone (PZ), landing zone (LZ), or convoy security. ● Provide security for air movement of personnel, supplies, and equipment in support of

Table 1-1. Attack reconnaissance battalion's role in Army warfighting functions

Army Warfighting Function	ARB's Role
	ground forces, refugees, or disaster victims.
C2	<ul style="list-style-type: none"> • Provide backup radio communications with supported forces.
Protection	<ul style="list-style-type: none"> • Provide direct fires and/or call for indirect fires to cover obstacles. • Provide security for ground movement, assembly area (AA), and fixed based operations.

DECISIVE, SHAPING, AND SUSTAINING OPERATIONS

1-8. The ARB may operate over a dispersed area of operations (AO) supporting their higher headquarters through decisive, shaping, and sustaining operations (FM 3-0).

Decisive Operations

1-9. The battalion participates in decisive operations to find, fix, and destroy enemy forces (especially moving forces), and to confirm intelligence. Decisive operations do not require the presence of overwhelming forces; they simply require the ability to mass overwhelming firepower and other effects at the time and place where the enemy's assets and strengths are most vulnerable. The battalion may be tasked to perform movement to contact or attack operations including close combat attack (CCA), interdiction attack (IA), or a raid. ARBs also support decisive operations by conducting reconnaissance to confirm intelligence.

Shaping Operations

1-10. Shaping operations establish conditions for success of the decisive operation by setting the battlefield to our advantage. Shaping includes lethal and nonlethal operations that make the enemy vulnerable to attack, impede or divert its attempts to maneuver, provide combat support to facilitate the maneuver of friendly forces, enhance deception, or otherwise dictate the time and place for decisive battle. Through shaping, commanders gain the initiative, preserve momentum, and control the tempo of combat. Shaping operations may occur with, before, or after initiation of decisive operations and may involve any combination of forces.

1-11. Some shaping operations, especially those that occur simultaneously with the decisive operation, are economy of force actions. If the available force does not permit simultaneous decisive and shaping operations, the commander sequences shaping operations around the decisive operation. A shaping operation may become the decisive operation if circumstances or opportunities dictate. In that case, the commander weighs the new decisive operation at the expense of other shaping operations.

1-12. In addition to finding, fixing, and destroying enemy forces and confirming intelligence, the battalion can facilitate shaping operations by—

- Conducting reconnaissance and surveillance (R&S) operations to complement other maneuver forces.
- Orchestrating joint air attack team (JAAT) operations.
- Providing security for air assault and air movement operations.
- Conducting feint and/or demonstration operations.

Sustaining Operations

1-13. Sustaining operations generate and maintain combat power. Failure to sustain normally results in failure of the overall effort. Sustaining operations at any echelon are those that assist the decisive and shaping operations by ensuring freedom of action and continuity of operations. Sustaining operations include base security, maintenance, sustainment, movement control, terrain management, and protection of lines of communications (LOCs) and headquarters.

1-14. The ARB elements are excellent for protecting sustainment forces as they move from one location to another, or in their AAs. The battalion also participates as an element in larger sustainment operations by providing R&S missions for LOCs and QRFs for sustainment areas.

SECTION II – MISSIONS

1-15. The primary missions of attack reconnaissance helicopter units are—

- Reconnaissance.
- Security.
- Attack.
- Movement to contact.

1-16. Reconnaissance operations are conducted to obtain information about the enemy and/or terrain to assist in building and sharing the common operational picture (COP), and/or to focus combat power at the decisive point and time.

1-17. Security operations provide reaction time, maneuver space, and protection to air-ground maneuver.

1-18. Attack operations destroy or defeat enemy forces in order to seize, retain, or exploit the initiative. Attack/reconnaissance units conduct two basic types of attack—CCA and IA.

- **Close combat attack.** A hasty or deliberate attack by Army aircraft providing air-to-ground fires for friendly units engaged in close combat. Due to the close proximity of friendly forces, detailed integration is required.
- **Interdiction attack.** A hasty or deliberate attack by Army aircraft to divert, disrupt, delay, degrade, or destroy the enemy before they can be used effectively against friendly forces. IA is conducted at such a distance from friendly forces that detailed integration with ground forces is not required.

1-19. Movement to contact operations are designed to develop the situation and to establish or regain contact. The commander conducts a movement to contact (MTC) when the enemy situation is vague or not specific enough to conduct an attack. A search and attack is a specialized technique of conducting a movement to contact in an environment of noncontiguous AOs.

ATTACK RECONNAISSANCE BATTALION

1-20. ARBs are often the division's primary reconnaissance asset during both offensive and defensive operations and complement the armor and lethality of forces in close combat. They have decisive advantages in maneuverability and lethality over other divisional resources for many mission applications. They can easily bypass obstacles and maneuver rapidly to positions of advantage, while exploiting the greater range of Hellfire missiles maintaining standoff against enemy armor and other hardened targets.

1-21. During a ground force's defense or attack against a known enemy force, aircraft may locate to the rear of the friendly force providing the ground commander SA of both friendly and enemy locations. Other attack reconnaissance aircraft, forming lead-wingman teams, may locate forward on both flanks to provide designation for Hellfire missiles in the close combat environment.

1-22. ARBs support ground force movement to contact, air assaults, and actions on contact through CCA. The reduced speed of a light infantry force's movement to contact, coupled with the need to maintain a low profile, may preclude escort by battalion aircraft. Instead, a company may operate over the supported unit or move to positions to overwatch and attack with supporting fires on one or both forward flanks.

1-23. The availability of multiple ARBs permits 24-hour operations, simultaneous attack of multiple engagement areas (EAs), or massed attack of multiple targets at a critical time and place.

AIR CAVALRY SQUADRON

1-24. The ACS performs the following missions in support of BCTs:

- Reconnaissance.
- Security.
- Air assault.
- Air movement
- Attack.
- Movement to contact.
- C2.
- Casualty evacuation (CASEVAC).

1-25. The ACS gathers information about enemy and terrain, maintains surveillance, and provides early warning of enemy contact. It provides reconnaissance, surveillance, and security of LOCs to enhance C2 and target acquisition (TA).

1-26. ACS assets have decisive advantages over other intelligence resources, as they can fight through and counter enemy deception efforts better than any sensor system.

1-27. The ACS, with its organic air cavalry troops (ACTs) and assault helicopter troop (AHT) helicopters, is an excellent force for developing the situation. As such, the ACS is often given its own sector and missions. Although ground forces extend the ACS's ability for continuous operations over time, the ACS is fully capable of conducting all reconnaissance missions, screens, and limited guard and cover operations. Attachment of ground forces enables the ACS to conduct guard and cover missions. The ACS also has organic utility aircraft that can insert surveillance teams at observation posts (OPs) and dismounted patrols.

1-28. The ACS generally conducts attacks as part of actions on contact to develop the situation further. The ACS may also conduct attacks to force the enemy to reveal information or continue the security mission. When the squadron can easily penetrate enemy defenses, it can more rapidly resume the advance or flank guard or screen mission. Such actions save time and maintain momentum.

SECTION III – ORGANIZATION

ATTACK RECONNAISSANCE BATTALION

1-29. Each heavy division combat aviation brigade (CAB) has two ARBs consisting of attack helicopter (AH)-64Ds only. Each light division CAB has two ARSs consisting of observation helicopter (OH)-58Ds only. Medium CABs, however, consist of one ARB (AH-64D) and one ARS (OH-58D). See FM 3-04.111 for more information on CAB's organization.

1-30. Each ARB (figure 1-1, page 1-6) has a headquarters and headquarters company (HHC), a forward support company (FSC), three attack reconnaissance companies (ARCs), and an aviation maintenance company. The distinction between ARCs and attack reconnaissance troops (ARTs) is an ARC consists of eight AH-64Ds, whereas, an ART consists of ten OH-58Ds. The ARB receives maintenance support from the CAB's aviation support battalion (ASB).

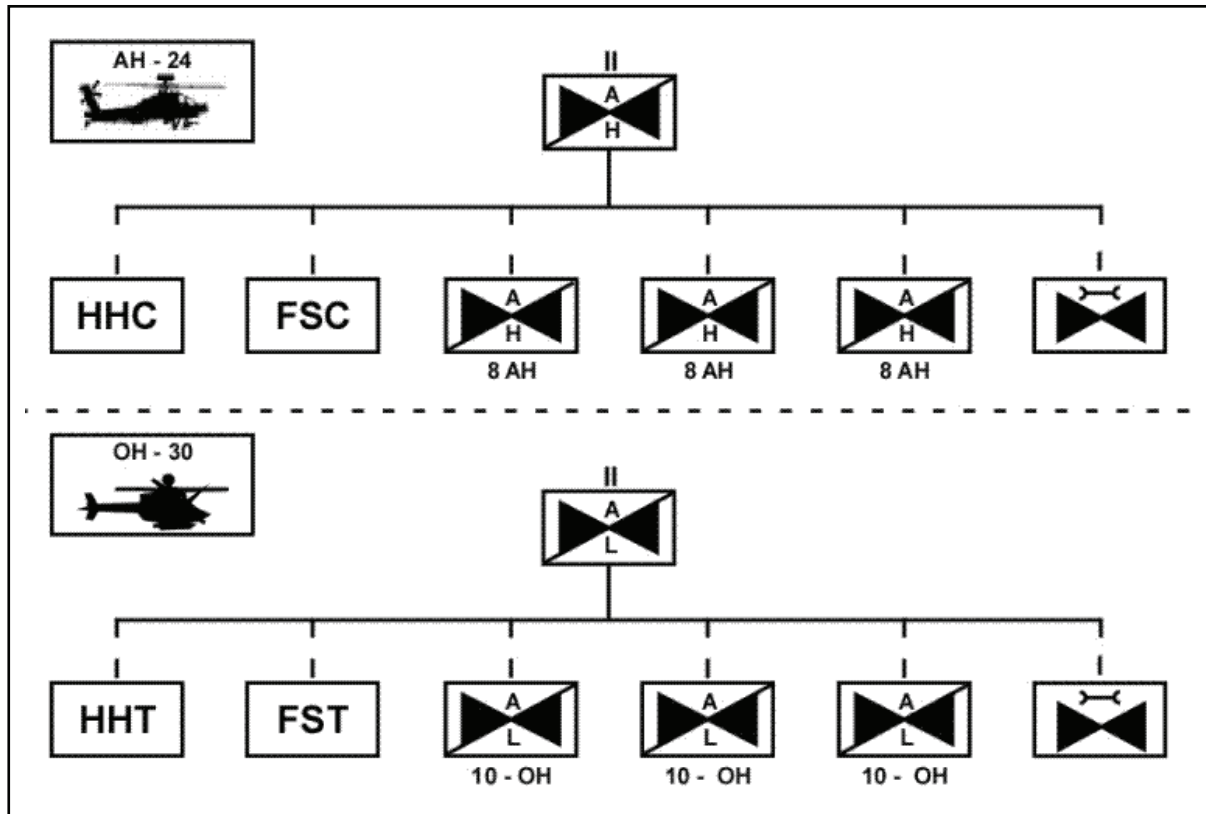

Figure 1-1. Attack reconnaissance battalion/attack reconnaissance squadron organization

1-31. The battalion is dependent upon the CAB or division for Army airspace command and control (A2C2), FS, weather, and specific personnel and administrative services.

HEADQUARTERS AND HEADQUARTERS COMPANY

1-32. The ARB HHC (figure 1-2) consists of the command group, staff, company headquarters section, supply section, communications/automation section, medical treatment squad, and unit ministry team (UMT). The HHC provides personnel and equipment for C2 functions of the battalion, and security and defense of the command post (CP). The HHC also provides the following types of support—unit-level personnel service, UMT, logistics, medical, and chemical, biological, radiological, and nuclear (CBRN). See chapter 4 for additional information.

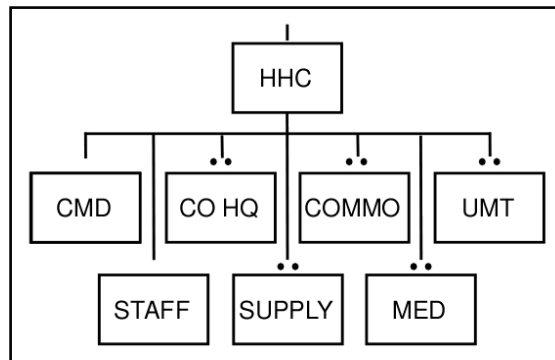

Figure 1-2. Attack reconnaissance battalion headquarters and headquarters company organization

Battalion Staff Organization

1-33. As described in FM 6-0, the battalion staff (figure 1-3) is organized into personal staff, coordinating staff, and special staff. The following paragraphs provide brief descriptions of essential battalion staff elements. Where necessary and appropriate, further discussion is contained in chapter 2.

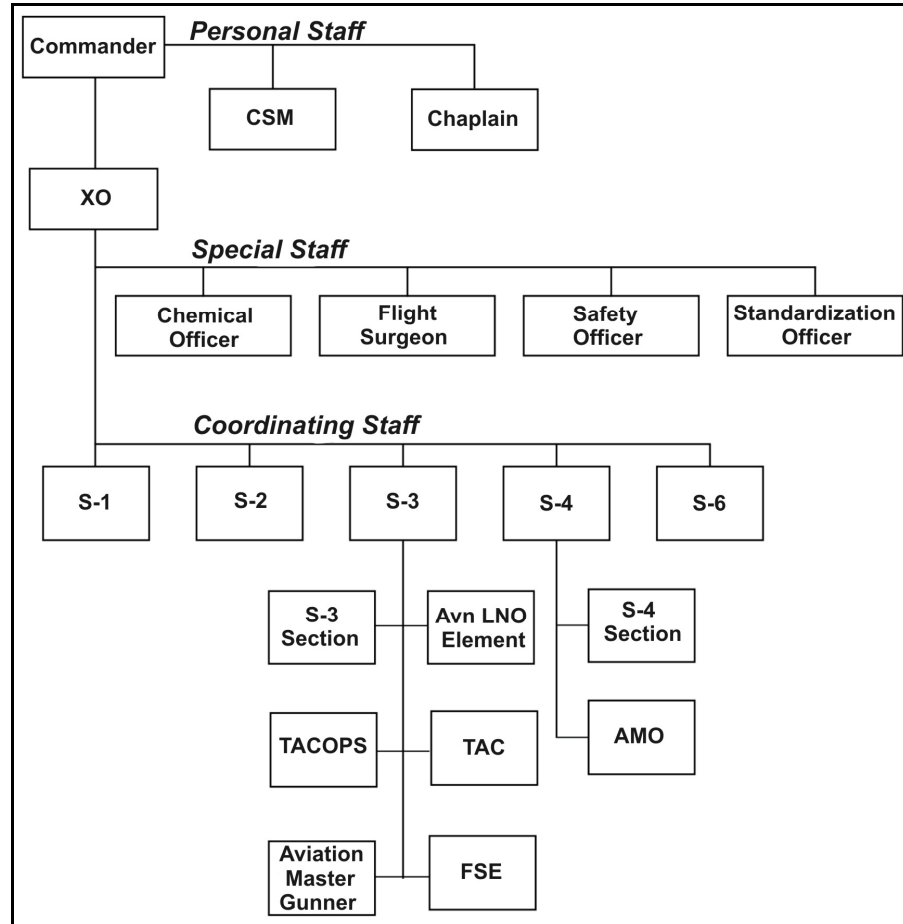

Figure 1-3. Attack reconnaissance battalion/attack reconnaissance squadron staff organization

1-34. The battalion staff consists of officers and enlisted personnel who plan, supervise, and synchronize operations according to the battalion commander's concept and intent. Except in scope, duties and responsibilities, the battalion staff is similar to those of higher echelon staff. Essential personnel must be positioned on the battlefield where they can carry out their duties. See chapter 2 for more information on staff duties and responsibilities.

Personal staff

1-35. The personal staff works under the commander's immediate control, but may work through the executive officer (XO) or a specific coordinating staff officer for coordination and control purposes. Members of the personal staff normally have a direct line of communications (LOC) to the commander due to the confidential nature and broad scope of their assigned duties.

Special staff

1-36. Special staff officers help the battalion commander and other staff members perform their functional responsibilities.

Coordinating staff

1-37. The coordinating staff is composed of the commander’s principal assistants responsible for one or a combination of broad fields of interest (personnel, intelligence, operations, logistics, planning, and communications). Coordinating staff members help the commander coordinate and supervise execution of plans, operations, and activities. Collectively, through the XO, they are accountable for the commander’s entire field of responsibility.

ATTACK RECONNAISSANCE COMPANY

1-38. The ARC (figure 1-4) consists of a company headquarters and two attack reconnaissance platoons with four AH-64D aircraft each. The ART consists of a headquarters element and two attack reconnaissance platoons of five OH-58D aircraft each.

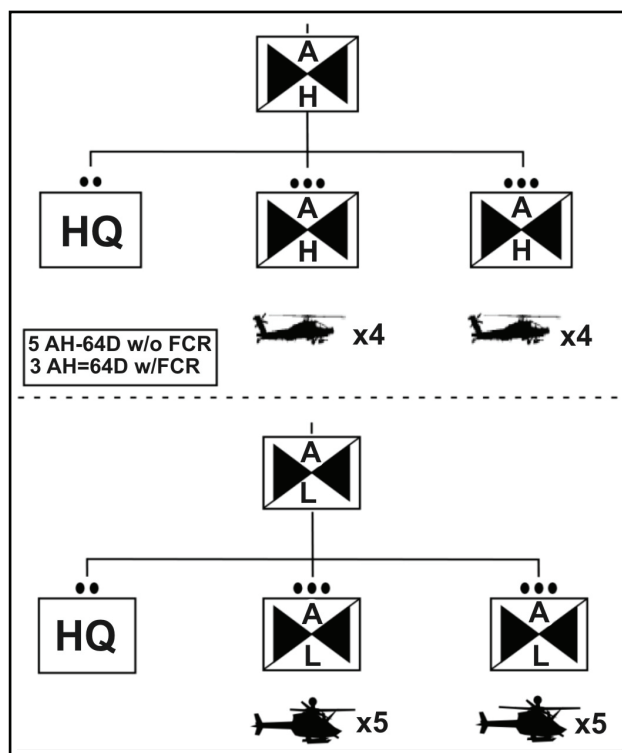

Figure 1-4. Attack reconnaissance company/attack reconnaissance troop

Headquarters Section

1-39. The company’s headquarters section embodies the senior leadership of the company and is responsible for leading, training, and caring for all Soldiers assigned to the company. Each member of the headquarters section must maintain proper communications between each element regarding company readiness. This communication is used to understand the company’s proficiency in individual through company tasks and allows development of the company’s training requirements. The commander, standardization instructor pilot (SP), safety officer (SO), and tactical operations (TACOPs) officer assigned to the headquarters section are part of the company’s aircrew structure.

The Attack Reconnaissance Platoons

1-40. ARC has two attack reconnaissance platoons consisting of four AH-64D aircraft. One attack reconnaissance platoon is organized with three AH-64D non-fire control radar (FCR) aircraft and one AH-64D FCR aircraft. The second attack reconnaissance platoon is organized with two AH-64D non-FCR aircraft and two AH-64D FCR aircraft. Each platoon utilizes two headquarters section aviators to employ all assigned aircraft.

1-41. The ART has two attack reconnaissance platoons consisting of five OH-58D aircraft. As with the ARC, each platoon utilizes headquarters section aviators to employ all assigned aircraft.

FORWARD SUPPORT COMPANY

1-42. The ARB FSC (figure 1-5) has a company headquarters, a field feeding section, a distribution platoon, and a ground maintenance platoon. The FSC provides field feeding, transportation, refueling, ground maintenance support, and coordinates with the ASB for additional support as required. See chapter 4 for additional information.

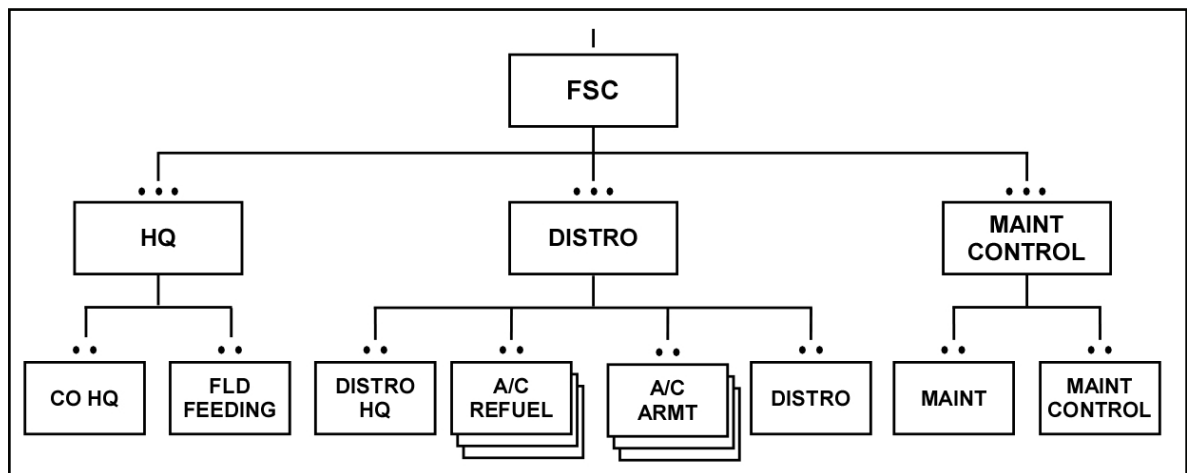

Figure 1-5. Attack reconnaissance battalion forward support company

AVIATION MAINTENANCE COMPANY

1-43. The aviation maintenance company (figure 1-6, page 1-10) consists of a company headquarters, production control and quality assurance (QA) sections, aircraft maintenance platoon, and an aircraft component repair platoon (CRP). The aviation maintenance company also provides necessary maneuver sustainment to operate autonomously throughout division operational environment. See chapter 4 for additional information.

AIR CAVALRY SQUADRON

1-44. The ACS augments and extends capabilities of the BCTs. The ACS contains a headquarters and headquarters troop (HHT), forward support troop (FST), three ACTs, one AHT, one aviation support troop, and one aviation maintenance troop. The ACS (figure 1-7, page 1-10) is equipped with 24 AH-64s or 30 OH-58Ds, and 10 utility helicopters (UH)-60s.

1-45. The squadron is dependent upon the Stryker brigade combat team (SBCT), division, or higher for A2C2, weather, legal, finance, and sustainment functions.

HEADQUARTERS AND HEADQUARTERS TROOP

1-46. The HHT provides personnel and equipment for battle command functions of the squadron, and security and defense of the CP. The HHT also provides UMT, logistics, and CBRN, and unit-level personnel service support.

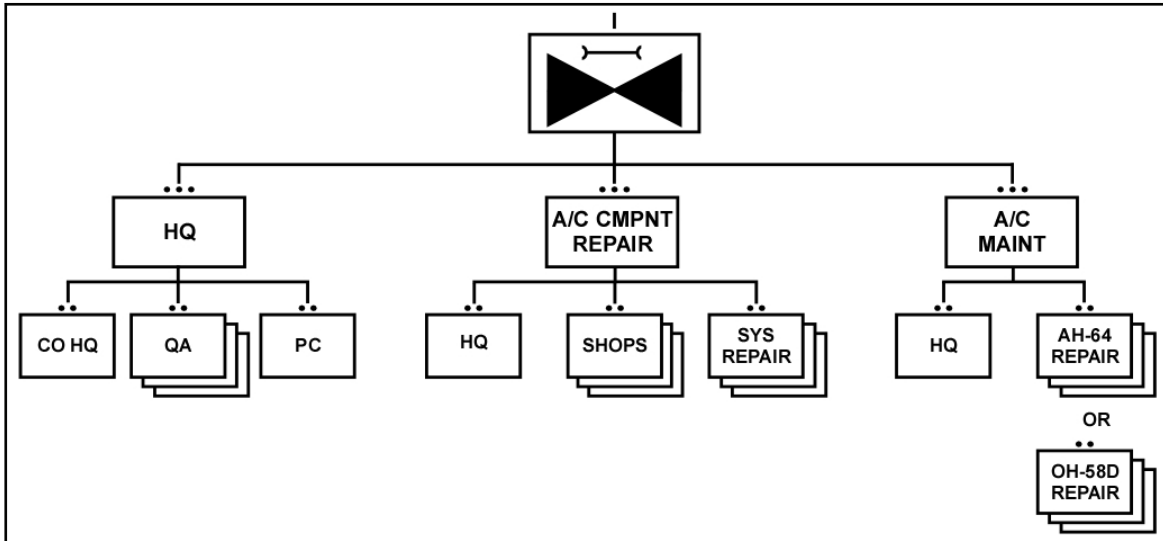

Figure 1-6. Attack reconnaissance battalion aviation maintenance company

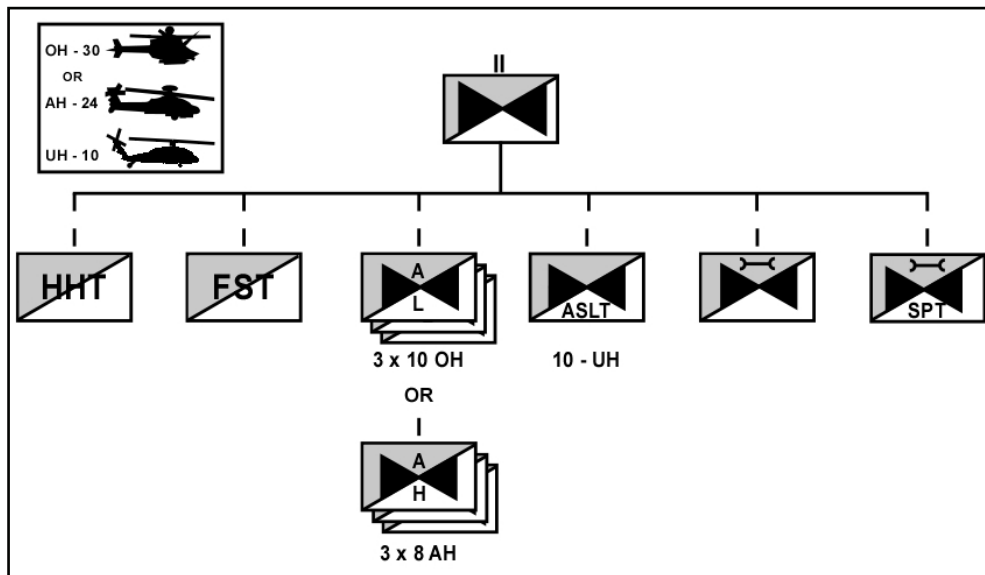

Figure 1-7. Air cavalry squadron

FORWARD SUPPORT TROOP

1-47. The FST has a headquarters platoon, distribution platoon, and ground maintenance platoon. The FST provides field feeding, transportation, refueling, and ground maintenance support and coordinates with the SBCT brigade support battalion for additional support as required.

AIR CAVALRY TROOP

1-48. The ACT consists of a headquarters section and two platoons of five OH-58D or four AH-64 aircraft each.

ASSAULT HELICOPTER TROOP

1-49. The AHT consists of a headquarters section and two flight platoons with five UH-60 aircraft each.

AVIATION MAINTENANCE TROOP

1-50. The aviation maintenance troop consists of a troop headquarters, production control and QA sections, aircraft maintenance platoon, and aircraft CRP. The aviation maintenance troop also provides necessary maneuver sustainment to operate autonomously throughout division operational environment.

AVIATION SUPPORT TROOP

1-51. The aviation support troop consists of a headquarters platoon, airframe repair platoon (ARP), and CRP. The aviation support troop performs intermediate maintenance and provides back-up unit maintenance in support of the aviation maintenance troop. The aviation support troop also performs production control and QA, conducts maintenance management, provides maintenance test pilot (MP) functions, and provides aviation and ground equipment maintenance for the squadron. See chapter 4 for more information.

Chapter 2

Command and Control

C2 is the exercise of authority and direction by a properly designated commander of assigned and attached forces. Command includes both the authority and responsibility for effectively using available resources to accomplish missions. To control is to regulate forces and functions to execute the commander's intent.

SECTION I – COMMAND AND CONTROL

COMMAND

2-1. Command at all levels is the art of motivating and directing people and organizations to accomplish missions. Command requires visualizing the current state of friendly and enemy forces, future state of those forces existing to accomplish the mission, and formulating concepts of operations to achieve success. The commander influences the outcome of operations by—

- Defining his intent.
- Assigning missions.
- Designating priority efforts.
- Prioritizing and allocating combat support and sustainment.
- Deciding what level of risk to accept.
- Placing reserves.
- Assessing needs of subordinates and seniors.
- Changing task organization.
- Changing allocation of combat support.
- Changing priority of sustainment.
- Changing boundaries.
- Allocating time.
- Guiding and motivating the organization toward the desired end.

Contents	
Section I – Command and Control	2-1
Section II – Battalion Command and Control	2-5
Section III – Company Command and Control	2-26
Section IV – Meetings and Briefings	2-34
Section V – Rehearsals	2-35
Section VI – End of Mission Debriefing and After-Action Review	2-38

CONTROL

2-2. Control of forces and functions helps commanders and staffs compute requirements, allocate means, and integrate efforts. Control is necessary to determine status of organizational effectiveness, identify variance from set standards, and correct deviations from these standards. Control permits commanders to acquire and apply means to accomplish their intent and develop specific instructions from general guidance. Ultimately, it provides commanders a means to measure, report, and correct performance. Control allows commanders freedom to operate, delegate authority, place themselves in the best position to lead, and synchronize actions throughout the operational area.

2-3. While C2 may be discussed separately for understanding, in practice, it is an entity. The commander cannot command effectively without control, and cannot exercise control without command. The commander uses C2 to make effective decisions, manage uncertainty of combat, employ forces efficiently, and direct successful execution of military operations. The goal of C2 is mission accomplishment, while the object of C2 is force effectiveness. The staff is the commander's most important resource to exercise C2 when he is unable to exercise it by himself. Commanders exercise authority and direction through and with assistance of a C2 system.

COMMAND AND CONTROL SYSTEMS

2-4. The C2 system is defined as the facilities, equipment, communications, procedures, and personnel essential to a commander for planning, directing, and controlling operations of assigned forces.

2-5. The Army battle command system (ABCS) provides unit commanders with electronic architecture to build SA. Signal planning increases the commander's options by providing the requisite signal support systems for varying operational tempos. These systems pass critical information at decisive times; thus, they leverage and exploit tactical success and make future operations easier. FM 3-04.111 has additional information on ABCS. The three levels of ABCS are—

- Global Command and Control System-Army.
- Army Tactical Command and Control System (ATCCS).
- Force XXI battle command—brigade and below (FBCB2).

2-6. C2 for the ARB is simplified by the capabilities of their advanced aircraft. Multiple frequency modulated (FM) radios, improved data modem (IDM), satellite communication (SATCOM)/high frequency (HF) (excluding OH-58D) capability, if so equipped, simplify communication and information reporting. As battalions field emerging SA digital systems, the C2 and subsequent responsiveness and lethality of the force will multiply.

COMMUNICATIONS

2-7. Fundamental to combat operations is combat information reporting and exploiting that information. This information and the opportunities it presents are of interest to other maneuver units and higher headquarters' staffs. Combat information reporting requires wide and rapid dissemination. Battalion elements frequently operate over long distances, wide fronts, and extended depths from their controlling headquarters. Communications must be redundant and long range to meet internal and external requirements. Long-range communications can be augmented through signal support. The answer is to have the systems in place before they are needed.

2-8. Operations at extended distances beyond friendly lines may require cellular, HF, tactical satellite, or retransmission (RETRANS) to maintain communications. UH-60 airborne C2 aircraft should be operational control (OPCON) to the battalion for all battalion-level and long-range operations. The aviation mission planning system (AMPS) provides a means of transferring information between echelons within the battalion and with the CAB. Brigade aviation elements (BAEs) are also AMPS and tactical airspace integration system airspace workstation-equipped to permit supported ground unit input.

COMMUNICATION RESPONSIBILITIES

2-9. All levels of command gain and maintain communications with necessary headquarters and personnel. Communications methods and procedures should be established in unit standing operating procedures (SOPs) and practiced during battle drills and flight operations.

2-10. Regardless of establishment responsibility, all units must take prompt action to establish or restore lost communications. Methods of restoring communications should be established in the unit SOP and practiced during battle drills and daily flight operations.

COMMUNICATIONS DISRUPTION

2-11. Communications, particularly electromagnetic, are subject to disruption in even the best conditions. Disruption may result from unintentional friendly interference, intentional enemy action, equipment failure, atmospheric conditions, electromagnetic pulse, or terrain interference. To compensate for intermittent communications, the commander should—

- Provide for redundancy in means of communication.
- Ensure subordinates understand commander's intent so they know what to do during communications interruptions.
- Avoid overloading communications systems.
- Minimize use of radio.
- Ensure personnel follow signal and communications security (COMSEC) practices.

OPERATIONS SECURITY

2-12. Operations security (OPSEC) includes measures taken to deny the enemy information about friendly forces and operations. OPSEC consists of physical security, information security, signal security, deception, and countersurveillance. Because these categories are interrelated, the commander normally chooses to employ multiple techniques to counter a threat. Commanders analyze hostile intelligence efforts and vulnerabilities, execute OPSEC countermeasures, and survey the effectiveness of countermeasures. Commanders can then counter specific hostile intelligence efforts.

BATTALION COMMUNICATION NETS

BATTALION INTERNAL RADIO NETS

2-13. The battalion establishes the following internal radio nets to organize and control information passed via each net:

- **Command net.** An FM secure command net, controlled by the operations staff officer (S-3), is used for battalion C2. As a rule only commanders, XOs, or S-3s communicate on the net. The command net is used by commanders for sending and receiving critical information on current operations.
- **Operations and intelligence net.** The intelligence staff officer (S-2) controls the operations and intelligence (O&I) net. Routine operations and intelligence reports (INTREPs) are sent on this net; it functions as a surveillance net when required. Brigade or subordinate commanders do not normally monitor O&I. This net is used for details and discussion leading to analysis. That analysis, when completed, is relayed to the appropriate commander. The unit XO, operating in the main CP, ensures analysis is done and relayed in a timely manner by appropriate means. When used, the rear CP monitors the O&I net allowing anticipation of critical support requirements and problems.
- **Administrative and logistics net.** This net is controlled by the personnel staff officer (S-1) and logistics staff officer (S-4) and is used for administrative and logistics (A&L) traffic. Battalion or subordinate commanders do not normally monitor the A&L net.

2-14. The battalion commander communicates with his company commanders on the battalion command net, which is FM secure. Very high frequency (VHF) and ultra high frequency (UHF) secure radios may be used as backups for the FM secure radio. The main CP may use the FM secure radio to communicate with the battalion trains and forward arming and refueling point (FARP) elements through the battalion A&L net. Battalion elements may also communicate with the FARP on the command net; at a minimum, FARPs should monitor the command net. If the A&L net is not active, the O&I network is an alternative to communicate A&L requirements. Table 2-1, page 2-4, illustrates typical internal radio nets.

Table 2-1. Battalion internal radio networks

NETWORK	BATTALION/SQUADRON						ARTILLERY	COMPANY	
	STATION	CMD FM	CMD HF (AM)	O&I FM	A/L FM	AVN UHF			FS FM
Command Group	X		A	A			X	X	
TAC CP	N		X				X		
Battalion Detachments	X	X		X	X			X	
Co CPs	X		X	O/A			O/A		N
Platoons								A	A
ISG				X					A
FARP	X			X					
N—Network control station X—Enter network A—Enter network as required O—Monitor									

BATTALION EXTERNAL RADIO NETS

2-15. The battalion main CP is responsible for maintaining communications with higher, adjacent, and subordinate units. When deployed, the battalion tactical command post (TAC CP) may communicate directly with these units. If the situation or terrain prohibits direct contact by the TAC CP, the main CP may act as a communications relay. When airborne, the battalion commander may communicate directly with higher headquarters, adjacent units, and subordinate elements via FM secure radio. The main CP and TAC CP, if deployed, operate the battalion command and O&I nets. These elements also maintain communication with higher headquarters on their command O&I, and A&L nets.

2-16. Because of distance factors involved, HF radios or SATCOM are often used to maintain contact with higher headquarters. Other external radio nets may be established through supporting elements such as the field artillery (FA) tactical fire direction system (TACFIRE), A2C2, and forces participating in JAAT operations. Table 2-2 illustrates typical external radio networks for the battalion.

Table 2-2. Battalion external radio networks

Division Control						
Station/Network	DIV CM FM	DIV REAR CMD FM	DIV CMD AM	DIV O&I FM	DIV Area Common User	DIV A2C2 FM
Command Group*	X	X1		X	X3	
TAC CP 1*	X2	X2	X	X2	X3	X3
Brigade Control						
Station/Network	BDE CMD	BDE O&I FM	BDE A/L FM	DIV Area Common User	AVN BDE UHF	
Command Group*	X	O/A	A	X	X	
TAC CP*	X2	X				
X—Enter network A—Enter network as required O—Monitor 1—When performing rear area operations 2—When deployed; otherwise, main CP 3—Always active 4—Network of brigade providing area support 5—Division command FM is normally an on-call network *—Enter A2C2 network as required						

SECTION II – BATTALION COMMAND AND CONTROL

2-17. CPs serve the C2 needs of the commander and staff. The dynamics of the operational environment require the highest level of organizational and operational efficiency within every CP. Battalion C2 elements and facilities are positioned according to the situation and include—

- Command group.
- Main CP.
- TAC CP.

BATTALION COMMAND GROUP

2-18. The battalion command group consists of the battalion commander and representatives from battalion staff and supporting units the commander chooses. At a minimum, this includes the S-3, an S-2 representative, fire support officer (FSO), and air liaison officer (ALO), if available. The command group may operate from ground vehicles or an aircraft. It is not a command facility per se, but a grouping of critical decision makers that may operate separately from the main CP or the TAC CP periodically. The command group may deploy when personal observation or presence is necessary to accomplish the mission.

COMMANDER

2-19. The commander's main concerns are accomplishing the mission and taking care of Soldiers. The commander delegates authority and fosters an organizational climate of mutual trust, cooperation, and teamwork. The commander leads the battalion, mentors, guides, trains, and inspires leaders and Soldiers. Commanders must also have an in-depth knowledge of enemy forces and how they fight, and possess the ability to use terrain to their advantage. The commander must maintain the highest level of proficiency in the aircraft and should be a pilot in command (PC).

2-20. The battalion commander must understand the impact of the unit's actions and the actions of the Soldiers on the modern battlefield. The battalion commander relies on staff and subordinate commanders to advise and assist in planning and supervising operations. The commander must understand the staff's capabilities and limitations and must train them to execute operational concepts during his absence. The commander focuses on essential aspects of employing the ARB to include—

- Commands the organization through the tenants of mission command.
- Positions to best see and influence the operational environment and gain SA.
- Provides planning guidance and commander's intent in accordance with his operational environment visualization.
- Makes recommendations to the supported commander on best employment of the ARB.
- Establishes the tempo, focus, and engagement criteria for attacks, reconnaissance and security.
- Determines acceptable risk for mission accomplishment and risk levels delegated to subordinates through the composite risk management process.
- Institutes necessary training for Soldiers in media operations, rules of engagement (ROE), personnel recovery (PR), and survival, escape, rescue, and evasion.

Commander's Location

2-21. When not in battle, the battalion commander normally operates from the vicinity of the main CP. During battle, the commander moves to a position to best make decisions necessary for influencing the outcome of the fight. The commander must be in a position to affect operations while maintaining communications with higher, lower, and adjacent units. The best location for the commander may be the main CP, the TAC CP, or forward with the battle. This decision is based on mission, enemy, terrain and weather, troops and support available, time available, civil considerations (METT-TCs) as well as

commander's assessment of personal presence essential to mission accomplishment. Even as digital linkages improve the ability to see the battle, at times there may be no option better than personal presence.

EXECUTIVE OFFICER

2-22. The XO is second in command and the principal assistant to the commander. The scope of XO duties are often tailored by requirements of the commander; however, in general, the XO directs, supervises, and ensures coordination of staff work and logistics except in those specific areas reserved by the battalion commander. During combat operations, the XO is generally positioned in the main CP directing and coordinating the staff. The XO remains current on tactical and logistics situations and is always prepared to assume command.

2-23. As staff coordinator and supervisor, the XO—

- Is responsible for execution of staff tasks and coordinates efforts of staff members for the orders process.
- Monitors unit status and mission execution to ensure conformity to the commander's intent and scheme of maneuver.
- Assesses/understands timely information updates and disseminates decisions early and instantaneously.
- Transmits the commander's decisions to the staff and subordinate commanders, when applicable. Staff members can deal directly with the commander; however, they are obligated to inform the XO of the commander's instructions or requirements.
- Establishes and monitors liaison and liaison activities.
- Is responsible for the command information program.
- Directs main CPs operations.
- Is responsible for planning and integrating logistics into the operational plan (OPLAN). The XO normally delegates responsibility for planning to the battalion S-4.
- Supervises maintenance operations.
- Oversees protection measures in fixed-base operations.
- Serves as the materiel readiness officer.

COMMAND SERGEANT MAJOR

2-24. The command sergeant major (CSM) is the commander's primary advisor concerning enlisted Soldiers and acts in the name of the commander in other duties as directed. The CSM focuses attention on functions critical to success of the operation. The CSM assists the commander in the following ways:

- Monitors food service and other logistics operations.
- Conducts informal investigations.
- Assists in controlling battalion movements.
- May lead battalion advance or quartering party during a major movement in coordination with the HHC commander.
- Establishes ground QRF guidelines for AA security.
- Monitors subordinate unit morale.
- Provides recommendations and expedites procurement and preparation of enlisted replacements for subordinate units.

STAFF RESPONSIBILITIES

Reduction of Demands on the Commander's Time

2-25. The staff reduces demands on the commander's time by—

- Obtaining, analyzing, and providing information.

- Anticipating the situation.
- Making recommendations. The staff does not ask the commander for solutions. It presents issues, offers courses of action (COAs), and recommends one of those COAs.
- Preparing plans and orders.
- Supervising the execution of orders.
- Coordinating the operation.

Maintains the Common Operational Picture

2-26. The staff provides the commander with an accurate picture of the AO. Delays in receiving or disseminating critical information adversely affect the entire operation. The staff must identify primary indicators and push for quick and accurate reports from both subordinate and higher headquarters. Information flow—both horizontally and vertically—must be on a priority basis. Operational conditions dictate priorities.

Running Estimates

2-27. Running estimates may be informal at battalion level and below; however, they must address operational environment activity, project COAs, and predict results. Careful IPB, selection of the most important enemy indicators, and development of contingency plans facilitate estimates and allow for timely response. The main person in this process is the XO, who ensures the staff maintains a proper perspective.

2-28. A running estimate is continuously updated based on new information as the operation proceeds (see FM 6-0). It is a staff technique that supports commander's visualization and decision making. Staffs continuously update their conclusions and recommendations based on the impact of new facts. Staff sections provide these updated conclusions and recommendations to the commander, as required, either by the situation or the commander (see FM 5-0). Normally, the coordinating staff provides running estimates during the conduct of operations using the personnel estimate, the intelligence estimate, the operations estimate, and the logistics estimate.

Staff Communications with the Commander

2-29. Information flow is critical. For some information, the commander must be informed immediately. It is essential the commander provide the staff with guidance on types of information he considers critical, typically through commander's critical information requirements (CCIRs). Many commanders emphasize the CCIRs by posting them in the main CP and disseminating to all Soldiers.

2-30. Staff members must provide the commander with critical, concise, accurate information and coordinate with higher and lateral units to provide the commander with their running estimates. The XO is essential in establishing guidance that ensures briefs do just that and not burden the commander with time-consuming, lengthy, or meandering discussions. Critical information is communicated to the commander on a priority basis set by command guidance. Established briefings to the commander are open and frank, but follow a set agenda.

Human Resource Section

2-31. The S-1 has coordinating responsibility for finance, religious activities, public affairs, and legal services support for the unit. The S-1 is normally collocated with the S-4 in the main CP. The S-1 and S-4 must cross train enabling them to conduct continuous operations.

2-32. The S-1 is responsible for all matters concerning human resources including personnel readiness and services. The S-1 also—

- Manages personnel strength and replacement.
- Works with the flight surgeon to plan health services.
- Coordinates morale support activities and legal, financial, and postal services.
- Maintains the awards program.

- Oversees the administration of discipline, law, and order with the provost marshal (if present) and brigade judge advocate.
- Provides casualty operations management.

Personnel estimate

- 2-33. The personnel estimate is prepared by the S-1 and focuses on critical personnel aspects to include—
- Personnel readiness.
 - Leave, school, and temporary duty status.
 - Casualty status.
 - Medical estimate (including level I, II, and III locations).
 - Personnel replacement status.

Chaplain

2-34. The chaplain provides religious support to all personnel assigned or attached to the battalion. The chaplain advises the commander on religious, morale, and Soldier welfare issues, and establishes liaison with UMTs of higher and adjacent units. The chaplain and chaplain's assistant compose the UMT, which usually operates from the same location as the S-1.

Flight surgeon

2-35. The flight surgeon advises and assists commanders on matters concerning the medical condition of the command, to include preventive, curative, and restorative care. The flight surgeon periodically flies with aircrews to monitor medical and environmental factors affecting crew readiness. The flight surgeon is responsible for conducting flight physicals for unit personnel. The flight surgeon determines requirements for requisition, procurement, storage, maintenance, distribution, management, and documentation of medical equipment and supplies and operates the battalion aid station (BAS), usually in the AA.

Intelligence Section

2-36. The S-2 assists the S-3 for matters concerning ISR. The S-2 provides current information and analyzed intelligence of tactical value concerning terrain, weather, and the enemy. This intelligence helps to facilitate planning and execution of combat operations.

2-37. The S-2 section staff provides combat intelligence, which includes collecting and processing information. The S-2 section staff prepares intelligence collection plans; receives and analyzes operational environment information; disseminates intelligence products; and provides up-to-date intelligence information assisting in planning for and coordinating close and rear battle operations.

Intelligence estimate

2-38. The intelligence estimate is prepared by the S-2 and may focus on critical intelligence elements to include—

- Terrain analysis/hazards map/digital photographs.
- Composition and disposition of enemy forces.
- Enemy capabilities and limitations.
- Incident overlays, significant activities, and or spot reports (SPOTREP).
- Pattern analysis of enemy activity to include direct fire engagements, indirect fire engagements, or improvised explosive devices (IEDs).
- Event templates based on enemy patterns.
- Populace and town assessments.
- Key dates and holidays that may impact or influence operations.
- Intelligence requirements.

- Status of collection assets.
 - Battle damage assessment (BDA).
- 2-39. The S-2 section staff also performs the following functions:
- Facilitates the IPB process.
 - Participates in development of the decision support template (DST).
 - Coordinates intelligence collection activities.
 - Updates the commander and staff frequently on enemy situation and trends.
 - Maintains isolated personnel reports (ISOPREPs).
 - Works closely with commander and S-3 ensuring updated intelligence information is used to plan battalion operations.
 - Develops the ISR plan with the S-3.
 - Performs terrain analysis.

Operations Section

Operations officer

2-40. The S-3 is responsible for matters pertaining to operational employment, training, and mission execution of battalion and supporting elements. The S-3 section staff produces orders for battalion operations, including recovery of personnel. The S-3 monitors the battle, ensures necessary assets are in place when and where required, develops the ISR plan, and anticipates developing situations.

Operations section

2-41. The S-3 section staff maintains routine reporting, coordinates activities of liaison personnel, and is always planning ahead. The S-3 ensures procedures are in place to resolve complexities posed by different communications systems, ATCCS, and connectivity with aircraft. The S-3 maintains close coordination with the S-4 and S-1 for logistics and personnel statuses.

Operations estimate

2-42. The operations estimate focuses on key aspects affecting current or future operations. It is prepared by the S-3 and may include—

- Task organization of internal and supported units.
- Graphic control measures.
- Locations and graphic control measures of supported units.
- Combat power/projections.
- Supported unit's significant activities.
- Future operations of supported units.
- ISR plan.
- Mission statement and commander's intent (two levels up and lateral supported units).
- Battle rhythm/fighter management cycles.
- Synchronization matrix.
- Liaison officer (LNO) status/reports.

Flight operations officer

2-43. Although not a TOE position, the commander may designate a battalion flight operations officer. NCOs and flight operations specialists assist the flight operations officer. The flight operations officer's responsibilities include the following:

- Monitoring and briefing applicable portions of special instructions (SPINS) and air tasking order (ATO) relevant to operations.

- Providing relevant A2C2 control measures to mission aircrews.
- Maintaining A2C2 overlay.
- Establishing and maintaining flight following net (air traffic control network) for unit aircraft, when required.
- Coordinating air traffic services (ATS) requirements.
- Maintaining the aircrew information reading file.
- Maintaining the flying hour program and individual flight record folders.

Tactical operations officer

2-44. The TACOPS officer advises the battalion commander and staff on appropriate aircraft survivability equipment (ASE) techniques and procedures for each mission. He can serve as the other crew member for the battalion commander or S-3, as well as a principal trainer and peer leader for the company TACOPS officers. Other responsibilities include, but are not limited to—

- Conducting the ASE/electronic warfare (EW) portion of the risk management process.
- Integrating the unit's OPLAN into the theater airspace structure.
- Assisting with development of unit tactics, techniques, and procedures (TTP).
- Managing the organization's PR program.
- Assisting in military decisionmaking process (MDMP), close air support (CAS), and FS planning.
- Operating of the battalion AMPS.

Aviation liaison element

2-45. Liaison teams from the S-3's liaison element represent the battalion at the headquarters of another unit to facilitate coordination and communication between the two units. Much of the air-ground coordination at BCT level is handled by the BAE at the respective BCT headquarters. The liaison team and BAE are not synonymous and perform two unique and different functions. For more information on BAE operations see the training circular (TC) 1-400.

2-46. Teams are headed by the LNO who must be well versed in all aspects of aviation operations. The team is expected to act as a cell in planning and battle tracking so operations can continue in the absence of the LNO. Liaison teams should be certified by the battalion through a standard process before deploying to a supported unit.

2-47. LNOs participate in the supported unit's MDMP ensuring aviation is effectively integrated into planning. LNOs ensure supportability of the COA and relay a clear task and purpose to the parent unit. Battalion commanders must empower LNOs to act on their behalf and ensure liaison teams are fully supported. In return, commanders expect LNOs to maintain positive two-way communication and not commit assets or approve changes to a plan without coordinating with the battalion S-3 or commander.

2-48. LNOs provide the supported unit with the following:

- Capabilities, limitations, and tactical employment of aviation and ATS assets.
- Assistance in preparing aviation estimates, plans, orders, and reports.
- Assistance in planning aviation missions.
- Coordination with airspace users and the higher A2C2 element for airspace management.
- The operational status of aviation assets and its effects on the supported unit's mission.
- Informing appropriate aviation units of current and possible future operations.
- Continuous communications with aviation units supporting the ground unit.

2-49. Liaison teams must have access to current battalion status information to provide the most accurate picture of aviation capabilities. Constant communication with the parent unit is essential for updates on aircraft, maintenance, aircrew, and FARP status.

2-50. Liaison teams must be properly equipped and manned to support 24-hour operations. Minimum equipment includes—

- Compatible automation equipment to provide connectivity between supported unit and battalion headquarters.
- Necessary vehicles and equipment required to operate on the move.
- Two single channel air-ground radio system (SINCGARS) radios and supporting antennas/equipment to monitor command nets and communicate with aviation units.
- Map of the AO with supporting battle-tracking tools and equipment.
- Aviation FMs, SOPs, charts (equipment weights), and checklists (movement tables) to assist in aviation planning and integration.

Fire support officer

2-51. The primary duty of the FSO is supporting the scheme of maneuver with fires. This is accomplished, in close coordination, with the battalion S-3 and commander. The FSO plans, controls, and synchronizes all lethal and nonlethal FS operations and coordinates joint suppression of enemy air defenses (J-SEAD). The FSO integrates offensive information operations into FS planning and integrates aviation in the counter fire fight. He works with the tactical operations center (TOC) and the A2C2 element regarding FA firing unit locations, changes to fire support coordination measures (FSCMs) and airspace coordinating measures (ACMs). The FSO maintains digital and voice communications to supporting artillery. In the absence of a supporting FSO, the S-3 section staff ensures FSO tasks are accomplished.

Safety officer

2-52. The SO is the commander's principal assistant during the risk management process and monitors all battalion missions to identify and address potential hazards; the SO has a direct LOC with the commander. The SO recommends actions allowing mission accomplishment in the safest manner possible. The SO can serve as the other crew member for the battalion commander or S-3. The SO is responsible to the flight operations officer for safety contents of the reading files.

Standardization instructor pilot

2-53. The SP is a primary advisor to the commander for the standardization program. The SP develops, integrates, implements, monitors, and manages the aircrew training and standardization programs. He also advises, as required, on crew selection process, employment of aircraft systems, sensors, and weapons. The SP acts as coordinating staff officer for standardization of reading files. He is also a principal trainer and peer leader for subordinate unit instructor pilots (IPs). The SP may serve as the other crew member for the battalion commander or S-3.

Master gunner

2-54. The battalion master gunner manages helicopter gunnery training and sustainment while deployed in theater. He also assists the TACOPS in selection of weapons and employment techniques during the mission planning process. In addition, the battalion master gunner is a primary advisor to the commander for the gunnery training program. He assists the S-3 in forecasting and allocating ammunition and monitors gunnery training device usage. He also develops gunnery training to include realistic target arrays and coordinates scheduling with local range-control officials. During training events, the master gunner serves as the primary scorer/evaluator on unit live-fire ranges. The master gunner works with the armament officer ensuring the readiness of the unit's helicopter armament.

Chemical officer

2-55. The chemical officer advises the commander on CBRN operations, decontamination, smoke, obscurants, and flame. The chemical officer works directly for the S-3 and is responsible for integrating CBRN into all aspects of operations. The chemical officer may have other S-3 section responsibilities, and can act as an assistant S-3 or battle captain when directed.

Logistics Section

Logistics officer

2-56. The battalion S-4, as the battalion's logistics planner, coordinates with companies concerning the status of maintenance, equipment, and supplies. The S-4 coordinates with supporting units and higher headquarters staffs ensuring logistics support is continuous.

Logistics section

2-57. The S-4 section staff provides supervision and coordination of food service, supply, transportation, and maintenance support for the battalion. The battalion S-4 is responsible for the logistics estimate. The FSC and aviation maintenance company commander assist the S-4 in development of key information to include—

- Maintenance status (aircraft, vehicles, unmanned aircraft system [UAS], and equipment).
- Classes of supply status and forecasts.
- Logistics synchronization matrix.
- Resupply schedule.
- FARP status and locations.

Aviation materiel officer

2-58. The aviation materiel officer (AMO) works with the S-4 and is an advisor to the battalion commander and staff for aviation materiel issues. The AMO reviews reports and makes recommendations on aviation logistics and maintenance issues. The AMO ensures close coordination with the aviation maintenance company and supporting ASB commanders. The AMO is usually a maintenance test flight examiner and serves as a trainer and peer leader for the subordinate unit aviation maintenance officers. The AMO is responsible to the flight operations officer for aviation maintenance contents of the reading files.

Signal Officer

2-59. The command, control, communications, and computer operations (C4 Ops) officer (S-6) advises the commander on signal matters, CP location, signal facilities, and best use of signal assets. The S-6 section staff plans for, coordinates, and oversees employment of communications systems and performs unit-level maintenance on ground radio and field wire communications equipment. It installs, operates, and maintains the battalion's radio RETRANS site. The S-6 monitors the maintenance status of battalion signal equipment, coordinates the preparation and distribution of the signal operation instructions (SOIs), and supervises COMSEC accounting activities. Included in the above signal responsibilities are supervision of electronic mail on both classified and unclassified nets and the unit local area network (LAN).

HEADQUARTERS AND HEADQUARTERS COMPANY HEADQUARTERS ELEMENT

2-60. The company command section consists of the commander and first sergeant (1SG). They are responsible for providing control and supervision of operations within the support area, and providing support for battalion staff and organic operational elements.

Commander

2-61. The commander's responsibilities include leadership, discipline, tactical employment training, administration, personnel management, supply, and communications activities. These responsibilities require the commander to understand the capabilities of the unit's Soldiers and equipment and know how to employ them to the best tactical advantage. At the same time, the commander must be well versed in threat organizations and doctrine.

2-62. The commander's mission involves more than company support; he is instrumental in providing support for the entire organization. Ultimately, he must know how to exercise the art and science of battle

command effectively and decisively. The commander must be flexible, using sound judgment to make correct decisions quickly and timely, based upon the higher commander's intent and the tactical situation. He must be able to visualize the operational environment, describe situations and operations, and direct subordinate leaders by using clear and complete combat orders.

First Sergeant

2-63. The 1SG is the company senior noncommissioned officer (NCO) and usually its most experienced Soldier. He is the commander's primary tactical advisor and an expert in individual and NCO skills. The 1SG enforces unit discipline and is the company's primary sustainment operator. He helps the commander plan, coordinate, and supervise all logistics activities supporting the tactical mission. The 1SG operates where the commander directs him or his duties require him. The 1SG also assists the commander in the following ways:

- Executes and supervises routine operations. This may include—
 - Enforcing tactical standing operating procedures (TACSOPs).
 - Coordinating and reporting personnel and administrative actions.
 - Supervising supply, maintenance, communications, and field hygiene operations.
- Implements the local security plan.
- Supervises, inspects, and/or observes all matters designated by the commander.
- Plans, rehearses, and supervises key logistics actions supporting the tactical mission. These activities include—
 - Resupplying classes I, III, and V products and materials.
 - Maintenance and recovery.
 - Medical treatment and evacuation.
 - Processing replacement/return to duty (RTD).
- Provides recommendations and expedites procurement and preparation of enlisted replacements for the company.
- Serves as quartering party NCOIC, as necessary.
- Monitors NCO development, promotions, and assignments. This includes assessment of the company's battle focused Soldier and NCO leader training programs.
- Identifies, plans, and assesses Soldier performance on training tasks supporting collective (unit) tasks on the mission essential task list (METL).

Supply Sergeant

2-64. The supply sergeant coordinates all supply requirements and actions with the 1SG and S-4. He requests, receives, issues, stores, maintains, and turns in supplies and equipment for the company. Usually, the supply sergeant's position is located with the HHC CP or near the ASB support area. The supply sergeant communicates with the HHC using TF A&L radio net or the FBCB2. The supply sergeant's specific responsibilities include—

- Managing the HHC cargo truck(s) and water trailer, and supervising the supply clerk/armorer.
- Monitoring unit activities and/or the tactical situation.
- Anticipating and reporting logistics requirements.
- Coordinating unit logistics requests and monitoring their status.
- Coordinating and supervising organization of the HHC logistics package (LOGPAC).

Human Resources Specialist

2-65. The human resources specialist performs personnel and administrative functions in support of the company. He advises the commander and members of the unit on personnel matters. He also prepares military and nonmilitary correspondence, messages, recurring and special reports, requisition forms, regulations, directives, SOPs, and similar materiel.

Chemical, Biological, Radiological and Nuclear Noncommissioned Officer

2-66. The CBRN NCO assists and advises the HHC commander in planning for and conducting operations in a CBRN environment. He is usually located with the HHC CP. The CBRN NCO plans, conducts, and/or supervises CBRN defense training, covering such areas as decontamination procedures and use and maintenance of CBRN-related equipment. The CBRN NCO's specific duties include—

- Assisting the commander in developing HHC operational exposure guidance in accordance with higher headquarters guidance.
- Making recommendations to the commander on CBRN surveys and/or monitoring, decontamination, and smoke support requirements.
- Requisitioning CBRN-specific equipment and supply items.
- Assisting the commander in developing and implementing the unit CBRN training program.
- Inspecting HHC elements to ensure CBRN preparedness.
- Processing and disseminating information on threat and friendly CBRN capabilities and activities including attacks.
- Advising the commander on contamination avoidance measures.
- Coordinating, monitoring, and supervising decontamination operations.
- Providing recommendations to the commander on mission-oriented protective posture (MOPP) levels.

Armorer

2-67. The armorer performs organizational maintenance on HHC small arms. He is also responsible for evacuating weapons to the direct support (DS) maintenance unit as needed. In addition, he usually assists the supply sergeant.

TACTICAL COMMAND POST

2-68. The TAC CP is established as a temporary C2 organization that directly assists the commander in controlling current operations. It must be able to communicate with higher headquarters, adjacent units, employed subordinate units, and the main CP. The TAC CP is equipped with communications equipment and ABCS that support the WFFs, including intelligence, movement and maneuver, and FS. It monitors the battalion command and O&I nets and the higher headquarters command and O&I nets. The TAC CP assists the commander in controlling current operations by—

- Maintaining the COP and assisting in developing SU.
- Developing combat intelligence of immediate interest to the commander.
- Maneuvering forces.
- Controlling and coordinating FS.
- Coordinating with adjacent units and forward air defense (AD) elements.
- Serve as the main CP in the event the main CP is destroyed or unable to function.
- Monitoring and communicating sustainment requirements, primarily classes III and V, to the main CP.

2-69. The TAC CP is small in size and electronic signature to facilitate security and rapid, frequent displacement. Its organization layout, personnel, and equipment must be in the unit SOP. The TAC CP section must be augmented to operate on a continuous basis.

2-70. The TAC CP is composed of designated personnel from the appropriate staff sections, and is the responsibility of the S-3 section. TAC CP personnel may also include—

- SP, TACOPS officer, and SO.
- S-2, FSO, ALO, engineer, and civil-military officer, if available.
- Representatives from the logistics cell.

2-71. METT-TC may dictate that an effective TAC CP will operate from a C2-equipped UH-60. In this situation, the number of personnel must be reduced.

MAIN COMMAND POST

2-72. The main CP is a C2 facility that contains the portion of the battalion headquarters in which the majority of planning, analysis, and coordination occurs (FMI 5-0.1). It serves as the synchronization point for the entire operation. The main CP has a broader and more future-oriented focus than the TAC CP. Led by the XO, the main CP focuses on controlling and synchronizing ongoing shaping operations, assisting the commander and TAC CP in the execution of the decisive operation, and planning future operations. It maintains the COP by receiving information from the TAC CP and from higher, lower, and adjacent units. The main CP controls current operations when the TAC CP is not employed. The main CP consists of the personal, coordinating, and special staff. These may include the S-2, S-3, S-4, and S-6. It may also include the UMT, flight surgeon with medical treatment teams, battalion SO, battalion standardization officer, and HHC headquarters elements. Additionally, FSC personnel locate in the main CP as required to facilitate FARP and other logistic requirements.

2-73. The commander operates from the main CP when not operating from the TAC CP, command vehicle, or an aircraft. The main CP is usually organized into two groups, the operations cell and plans cell. The operations cell usually operates in shifts ensuring 24-hour ability; the plans cell may or may not operate on a 24-hour cycle.

OPERATIONS CELL

2-74. The operations cell includes the following functional positions:

- **Battle captain.** The battle captain is usually the most experienced operations officer other than the S-3. He continuously monitors operations ensuring proper personnel are available for the mission at hand. He does not command the battle, but performs battle tracking and makes operational decisions within assigned responsibilities. Each operations cell must have two to three battle captains to maintain 24-hour operations.
- **Noncommissioned officer-in-charge.** The operations NCO is normally the noncommissioned officer in charge (NCOIC) and is responsible for—
 - Movement, setting up, and maintaining the physical functioning of the main CP.
 - Shift schedules and organization within the main CP.
 - Other functions as assigned.
- **Operations noncommissioned officers.** S-3 NCOs and other assigned personnel assist the NCOIC in support of main CP functions. Other areas of responsibility may include—
 - Maintaining unit status.
 - Receiving and processing reports.
 - Keeping the unit's journal.
- **Intelligence personnel.** The S-2, S-2 NCO, and intelligence analysts are responsible for all intelligence functions to include—
 - Alerting the commander, XO, or S-3 to situations meeting established CCIR.
 - Receiving incoming tactical reports.
 - Processing intelligence information.
 - Assisting in moving, setting up, and maintaining the physical functioning of the CP.
- **Logistics personnel.** The logistics cell is composed mostly of the S-1 and S-4 sections, and representatives from attached sustainment elements. The logistics cell—
 - Monitors and assists in C2 of sustainment assets by maintaining contact and coordination with higher and adjacent units, while continuously updating the personnel and logistics situation.

- Maintains SA and SU ensuring sustainment elements are not adversely affected by enemy actions, friendly movements, or ongoing operations.
- Analyzes and disseminates sustainment information, maintains the sustainment situation map, and requests and synchronizes sustainment as required.
- Ensures reports are submitted and received on time.
- Plans for future operations in synchronization with the plans cell to ensure sustainment is integrated into the mission effort.
- **Fire support personnel.** The FSO and FS NCO, as part of the fire support element (FSE), are responsible for FS. Responsibilities include—
 - Expediting clearing fires.
 - Coordinating for responsive fires.
 - Assisting in moving, setting up, and maintaining the physical functioning of the main CP.
- **Radio telephone operators.** Radio telephone operators (RTOs) are critical links in the C2 structure. They often use radio headsets, answer telephones, and operate computer consoles. As such, they may be the only people who hear transmissions or see a critical piece of information. They must be well aware of the operation so they can alert the leadership of any situation that might require their attention. RTOs cannot assume all calls, information, and reports they monitor are also monitored or seen by the main CP at large.

PLANS CELL

2-75. The plans cell, due to its personnel-intensive nature, is activated as required. Normally the plans cell chief is the senior S-3 representative. It consists of the following personnel required to adequately plan for operations:

- Primary staff.
- FSO.
- TACOPS) officer.
- Attached unit representatives.

MAIN COMMAND POST FUNCTIONS

2-76. The main CP coordinates, directs, and controls operations and accomplishes planning for future operations. The main CP—

- Maintains communications with subordinate, higher, and adjacent units.
- Provides information and assistance to the commander and subordinate commanders.
- Operates on a 24-hour basis.
- Conducts future planning continuously.
- Maintains a continuous estimate of the situation.
- Maintains SA across Army WFFs.
- Maintains the status of the reserve.
- Receives, evaluates, and processes tactical information from subordinate units and higher headquarters.
- Maintains maps graphically depicting friendly, enemy, and noncombatant situations.
- Maintains journals.
- Validates and evaluates intelligence of interest to the commander.
- Controls all immediate FS, including CAS for units under ARB C2 (may also be done by TAC CP).
- Coordinates airspace C2 and AD operations.
- Relays instructions to subordinate units.
- Coordinates maneuver, combat support, and sustainment requirements.

- Coordinates terrain management for C2 facilities.
- Maintains aircraft, combat support, and sustainment capabilities and status.
- Tracks and logs combat losses.
- Submits reports to higher headquarters.
- Makes recommendations to the commander.
- Prepares and issues fragmentary orders (FRAGOs), operating orders (OPORDs), OPLANs, intelligence summaries, INTREPs, and situational reports (SITREPs).

MAIN COMMAND POST SITE SELECTION

2-77. The most important considerations for selecting any CP site are security and communications with higher, subordinate, and adjacent headquarters. Range of enemy artillery, accessibility to adequate entry and departure routes, cover, concealment, drainage, and space for dispersing are other considerations. An adequate LZ should be nearby. The S-3 selects the general location of the CP. The HHC commander and communications officer normally select the exact location. When selecting the general location of the CP, the S-3 should also select at least one alternate site should the primary site prove inadequate.

2-78. The HHC commander, along with his organic assets, has various weapons systems to integrate into the security plan based on the task organization. Given the number of personnel and vehicles in an area, the HHC commander must understand command relationships and plan accordingly for their support. It is important for attached elements to understand their relationship to the HHC. The element or staff section may work for the battalion commander or S-3 when DS or attached; however, they also assist the HHC commander in support and defense of the area. Generally, these elements coordinate with the commander for integration into the security plan, positioning, and sustainment. They must keep the HHC ISG informed of their administrative/personnel status at all times

Offensive Operations

2-79. During offensive operations, the main CP should be well forward. In fast-moving operations, the main CP may have to operate on the move. Staff coordination and communications are usually degraded when CPs are moving, thus, CPs must train to operate while moving.

Defensive Operations

2-80. During defensive operations, the main CP normally locates farther to the rear minimizing its vulnerability. The exact location depends on the enemy, terrain, road network, and ability to communicate.

Urban Operations

2-81. The main CP may set up in built-up areas for urban operations. Barns, garages, and warehouses minimize the need for detailed camouflage. Basements offer protection from enemy fires. Built-up areas also reduce infrared (IR) and electromagnetic signatures.

Reverse Slopes

2-82. Reverse slopes cover and conceal CPs from direct observation and fires. Reverse slopes can degrade the enemy's ability to collect, monitor, and jam electronic transmissions. Electronic profiles reviewed by the S-6 provide information for determining the ability to transmit and receive. Analysis of those profiles by the S-2 provides information for determining the enemy's ability to degrade CP capabilities or intercept traffic.

Prominent Terrain Features

2-83. Units should avoid establishing CPs on prominent terrain or major road junctions. Such features are often enemy preplanned artillery and air targets.

MAIN COMMAND POST MOVEMENT

Displacing the Command Post

2-84. The main CP displaces in either a single or phased move. The method selected depends on METT-TC, distance to be moved, and communications requirements. Movement degrades communication on all nets; however, the higher headquarters, battalion, and subordinate command nets must be maintained. An administrative move may entail both the main CP and TAC CP moving simultaneously to a new AO. Maintaining contact with higher headquarters may require alternate communications means, such as aircraft or vehicle mounted systems. When operations are ongoing, moving the main CP is accomplished in a phased move requiring displacement of the TAC CP. Critical aspects of C2, such as contact with higher headquarters and subordinate units, must be maintained during displacement. Displacements are planned to ensure the main CP is stationary during critical phases of the battle.

2-85. Usually, the main CP hands the battle over to the TAC CP and displaces by echelon using the following techniques:

- The main CP conducts a battle update briefing (BUB) for the TAC CP and transfers the battle.
- The first echelon eavesdrops while moving to the new location.
- The second echelon continues to execute CP responsibilities.
- The first echelon establishes itself at the new location and updates its SU with information it receives from the second echelon.
- The first echelon assumes responsibility for CP operations and the second echelon displaces.
- During movement, the number of messages to the CP should be minimal. This may require reconfiguration of auto-send and auto-forward functions to route traffic to the TAC CP during main CP displacement.
- Once the second echelon is established, the TAC CP conducts a BUB for the main CP.

2-86. The small unmanned aircraft system (SUAS) influences the decision to move the main CP. When the SUAS is conducting surveillance, the ground control station controlling the SUAS cannot move. Also, the security of the SUAS landing area is another important consideration.

Displacement Steps

2-87. The battalion XO/S-3 issues a warning order (WARNO) for the movement of the main CP. Leaders usually identify more than one site and route for the new main CP location. The site is not finalized until it has been reconnoitered. The HHC commander uses the overall tactical movement planning, preparation, and execution considerations discussed in appendix A. Subsequent paragraphs include discussions about the main CP movement.

2-88. The S-3 establishes the general area for the new CP. The HHC commander, signal officer, CSM (or senior NCO), and a CBRN team conduct detailed reconnaissance. The following are steps for displacement:

- The reconnaissance party identifies possible routes and sites. Locations must provide effective communications and accommodate all required aircraft, vehicles, and equipment. Several possible site locations must be identified, reconnoitered, and planned to provide flexibility and alternate sites.
- The reconnaissance party makes route and site sketch maps showing the exact element locations within the new CP location.
- The SO surveys the site for aircraft parking suitability.
- The S-3 or commander approves the primary and alternate sites.
- A ground/air movement order is published with decision points (DPs) and a security plan.
- Security personnel and guides are dispatched. The security force ensures the area is clear of enemy and contamination, and the guides prevent wrong turns and assist elements in occupation. Signals are especially important for low visibility and night displacements.

- Reporting and coordinating functions are shifted as required. The shift may be within main CP echelons, to the TAC CP, or to an alternate CP.
- CP and HHC elements prepare and execute movement per SOP. The main CP may displace in one echelon if the TAC CP can provide C2 for the interim. If the TAC CP cannot execute required C2, the main CP displaces in two echelons. The first echelon displaces with enough assets and personnel to establish minimum C2. The second echelon remains in place and provides C2 until the first echelon assumes control, then it displaces.

Planning Considerations

2-89. The HHC commander quickly gains an understanding of the mission requirements, translating these requirements into a movement order, assembles the convoy, and issues the order. NCOs must be able to organize and assemble the convoy, conduct precombat checks (PCCs)/precombat inspections (PCIs), and ensure personnel complete rehearsals. The convoy commander takes the required time to write an order and create a terrain model and prepares to issue the order.

2-90. During troop leading procedures (TLP), the HHC commander (and subordinate leaders, as necessary) performs standard tasks prior to a tactical road march that include—

- Conducting an analysis of METT-TC factors. This helps to assess the threat situation and determine probability of air or ground attack.
- Developing a timeline for the preparation and movement of the main CP.
- Designating a marshalling area to organize the march column and conduct final inspections and briefings.
- Establishing detailed security measures.
- Rehearsing actions on contact drills.
- Conducting convoy rehearsal.
- Designating the movement route, including the start point, required checkpoints, rally points, and the release point (RP). Additional control measures the team might need to identify include critical areas, defiles, choke points, rest and maintenance stops, and danger areas.
- Organizing, briefing, and dispatching the quartering party.
- Specifying the march speed, movement formations, vehicle and serial intervals, catch-up speed, lighting, and times of critical events.
- Establishing the order of march. Key headquarters positions in the order of march must enable continuous C2 and maximum protection using available combat assets. Based on its size, the organization divides into multiple serials.
- Planning for indirect FS and contingency actions, and rehearsing actions on contact. Contingency plans should cover vehicle breakdowns, lost vehicles, and accidents.
- Coordinating for sustainment, including refueling, mess operations, vehicle recovery, military police assistance, and medical evacuation (MEDEVAC).
- Preparing and issuing an order upon completion of the planning tasks.

Quartering Party

2-91. The quartering party assists the HHC in moving to and occupying a new AA in a new site of operations. The HHC dispatches a quartering party to the prospective site in advance of the main body to—

- Reconnoiter the site and route used to approach and occupy it.
- Secure the area prior to occupation.
- Organize the area prior to the main body's arrival.

2-92. Upon receipt of the movement WARNO, a reconnaissance team from the quartering party travels to the new area. If either the routes or AAs prove unsatisfactory, the quartering party advises the XO/S-3 of their findings and recommends changes, if possible. The HHC TACSOP should designate members of the reconnaissance team to assist reconnaissance in special ways, such as—

- Determining if the new area can support HHC operations and C2.
- Determining if the location selected can support the main CP.
- Identifying sites able to support communications and RETRANS.
- Conducting CBRN reconnaissance of the new site as METT-TC dictates.
- Providing additional security, as available.

2-93. Time available for the reconnaissance team to complete its mission varies depending on the situation. The reconnaissance team reconnoiters routes the main body will use, and identifies built-up areas, grades, fords, obstacles, and defiles affecting the move. The team also identifies alternate routes to the new site and rally points. Once the HHC selects a site, it conducts CBRN reconnaissance of the site. The reconnaissance team leader then compiles graphics for the routes and area, and sends them to the quartering party via FBCB2, if available. When possible, the team leader directs a security element to observe the new site. The remainder of the team returns to the main CP as some members of the reconnaissance team may also be part of the quartering party.

2-94. While the reconnaissance team is at work, the HHC 1SG assembles and conducts PCIs of the quartering party. The quartering party should be prepared to move two hours prior to actual movement of the main body. The HHC TACSOP should include quartering party task organization and operation. Elements in the quartering party should include representatives from each element comprising the main CP, namely:

- HHC section.
- S-3 representative.
- S-6 representative.
- Signal team.
- Chemical reconnaissance team.
- Security team, if available.
- Additional vehicles as required.

2-95. The HHC commander prepares and issues a movement order. During the move from the start point through the RP to the site, the quartering party verifies the route selected by the reconnaissance party is still able to support the unit's operations. When the quartering party reaches the new site, it verifies the site will support the main CP, and begins to prepare the site for occupation by the main body. The quartering party first establishes security and communications. The quartering party identifies and marks vehicle and crew-served weapons positions, and routes from the RP to the AA and positions. Guides from specific sections help to position vehicles when they arrive.

Main Body Actions

2-96. Upon arrival of the first main CP convoy serial at the RP, quartering party guides meet the main body and guide it into position. Once all vehicles are in position, each platoon/section establishes 100 percent local security. Platoon/section sergeants walk the perimeter with a quartering party guide, making adjustments to crew-served weapons or individual fighting positions, if needed. Platoon/section sergeants ensure all positions tie into the CP perimeter, and coordinate fires with left and right positions.

2-97. Once the last serial arrives, the HHC commander inspects the main CP perimeter. If satisfied with the defensive layout, the commander can reduce security to a level appropriate to the threat condition. All sections then begin the occupation timeline, and each vehicle immediately deploys rolls of concertina wire on the perimeter.

2-98. The main CP follows an occupation timeline (table 2-3, page 2-21).

Table 2-3. Example of main command post occupation timeline

Within 5 minutes	<ul style="list-style-type: none"> • Clear RP without stopping and pick up quartering party guides. • Move directly to marked positions. • Account for personnel, equipment, and sensitive items. • Report sent to HHC commander.
Within 30 minutes	<ul style="list-style-type: none"> • Maintain security and air guard. • Digital and FM communications established. • Vehicles in final positions. • Main CP vehicles connected. • Crew-served weapons in hasty fighting positions. • Hasty defensive and survivability positions designated. • Entry point gate established with barriers and communications to the main CP. • Sector sketches started. • CBRN detection equipment emplaced. • Initiate set-up of main CP.
Within 60 minutes	<ul style="list-style-type: none"> • Platoons/sections establish land line communications to each crew-served weapon position. • Logistics support areas (LSAs) sites finalized. • Complete security plan. • Complete set-up of TAC CP. • Establish casualty collection points (CCPs). • Emplace inner concertina wire.
Within 90 minutes	<ul style="list-style-type: none"> • Begin emplacement of outer ring of wire or berm. • Land line communications checks completed. • LSAs established. • Establish security defense level. • Vehicle/tent camouflage started.
Within 2 hours	<ul style="list-style-type: none"> • Guard and patrol rotation started. • Continued improvement of machine gun and individual fighting positions. • Helicopter LZ identified and marked. • Sector sketches to HHC commander.
Within 4 hours	<ul style="list-style-type: none"> • Refuel and resupply basic load. • Update maintenance status. • Perimeter wire continued until triple strand is emplaced. • QRF rehearsal. • Camouflage complete. • Continue to improve machine gun and individual fighting positions. • Implement CP shifts and sleep plan. • Check load plans.

BATTALION PLANNING CONSIDERATIONS

2-99. The battalion develops its OPLANs parallel with both higher headquarters and subordinate companies. Battalions must send a representative to brigade planning and coordination meetings and demand company input into battalion planning. In addition to planning for the operational mission,

battalion and companies ensure the myriad of details of aviation operations are accomplished. Units plan, coordinate, and rehearse concurrently while the OPLAN is in development. Examples of ongoing preparation include—

- Fighter management cycles.
- Task organization.
- Aircraft designation and configuration.
- Weapons system and ammunition mix.
- Auxiliary fuel tank distribution and management (if applicable).
- Communications planning.
- ASE requirements and settings.
- Identification, friend or foe (IFF) procedures and Mode 4 settings.
- Airspace C2 coordination.
- Review of the current air control order (ACO), ATO, and SPINS.
- Crew selection.
- Tasks and responsibilities (company, platoon, team, aircrew).
- En route formations and security.
- Formation actions on contact and break-up procedures.
- Selected rehearsals and training.
- FARP movement, composition, and emplacement.
- Maintenance support movement, composition, and emplacement.
- Plans and procedures for recovery of personnel and equipment, specifically downed aviator pickup points (DAPPs), in-stride/immediate aircrew recovery, and downed aircraft recovery teams (DARTs).
- Weather (to include inadvertent instrument meteorological conditions [IIMC] recovery procedures).
- Creation of emergency global positioning system (GPS) recovery procedure if required.
- Passage of lines planning.
- AD status.
- AA departure procedures.
- Bump plan.

2-100. Operations beyond friendly lines feature extended distances and tremendous speeds in execution. This may involve deep penetrations, wide sweeps, and bypassing enemy forces and terrain obstacles, almost always at night. To react quickly to intelligence on hostile forces, planning and execution must keep pace with the accelerated attack tempo, maximizing surprise to ensure effective execution at the decisive place and time.

MILITARY DECISIONMAKING PROCESS

2-101. To plan and coordinate missions effectively, the commander and staff follow the MDMP (figure 2-1, page 2-23). Staff planners must focus on the previously listed aviation planning considerations to formulate a complete plan. Because of the complexity inherent in the process, battalions should practice the process regularly prior to deployment. FM 5-0 covers the MDMP process in detail.

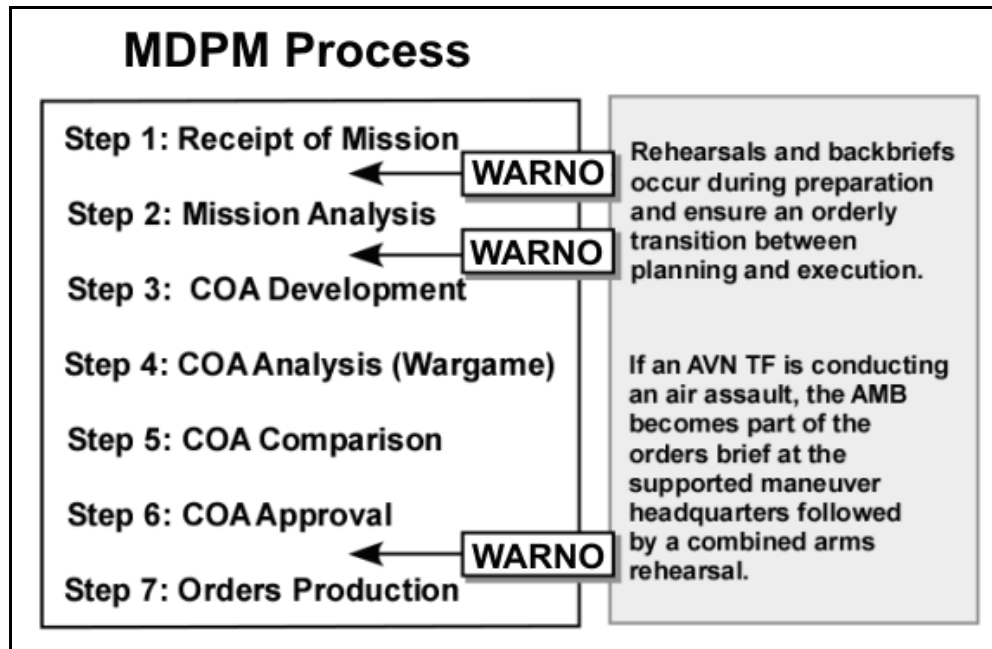

Figure 2-1. Military decisionmaking process

2-102. The dynamic battlefield often does not allow a complete MDMP due to of time constraints. The commander and staff must know current aircraft and crew availability to immediately assess feasibility of mission requests.

2-103. The steps of an abbreviated MDMP are the same as those of the full process; however, the commander performs many of them mentally or with less staff involvement. The commander may direct a COA based on experience to expedite planning. The products developed during an abbreviated MDMP may be the same as those developed using the full process; however, they are usually less detailed and some may be omitted altogether. Unit SOPs should address how to abbreviate the MDMP based on the commander's preferences.

DECIDE, DETECT, DELIVER, AND ASSESS METHODOLOGY

2-104. Decide, detect, deliver, and assess (D3A) methodology facilitates attack of the right target or objective with the right asset at the right time. It was developed principally for targeting. Although D3A applies to Army aviation, it does so in a slightly different manner. For aviation, D3A is much more than targeting. D3A is normally conducted at brigade level; however, modularity may require aviation task forces (ATFs) to perform this function. FM 5-0 provides more information.

2-105. D3A is used in every aspect of mission planning. What must be accomplished may be included in the orders/directives from higher/supported headquarters or it may fall squarely on the commander. D3A helps the commander decide what to attack, how to acquire necessary enemy information, when best to attack, and how to attack in a way that meets the higher commander's intent. Finally, it enables the commander to know whether the guidance has been met.

2-106. A high-value target (HVT) is a target the enemy commander requires for successful completion of the mission. The loss of HVTs seriously degrades important enemy functions throughout the friendly commander's area of interest.

2-107. A high-payoff target (HPT) is a target whose loss to the enemy will significantly contribute to success of the friendly COA. HPTs are those targets, identified through wargaming, which must be acquired and successfully attacked for the success of the friendly commander's mission.

Decide

2-108. During the decide function, the staff focuses and sets priorities for intelligence collection and attack planning. Based on the commander's intent and concept of the operation, the staff establishes targeting priorities for each phase of the operation. The high-payoff target list (HPTL) and attack guidance matrix are developed during this function. The decide function is completed at the command above company level.

Detect

2-109. The detect process finds the HPTs (critical enemy forces) to attack accomplishing the mission for each phase of an operation. TA assets and agencies execute the intelligence collection plan and focus on specific areas of interest. The force must detect and track mobile HPTs maintaining a current target location. Target tracking is inherent to detection and is executed throughout the collection plan. Tracking priorities are based on the commander's concept of the operation and targeting priorities.

2-110. The S-2 is the main figure in directing the effort to detect HPTs identified in the decide function. He determines accurate, identifiable, and timely requirements for collection systems. The detect function involves locating HPTs accurately enough to engage them. It primarily entails execution of the intelligence collection plan.

Deliver

2-111. The deliver function executes attack guidance and supports the commander's battle plan following location and identification of HPTs. Both tactical and technical decisions affect selection of the attack system and the unit to conduct the attack. The decisions are reflected in the staff's earlier development of the attack guidance matrix, schemes of maneuver, and FS plans for planned targets. The decision to attack targets of opportunity follows attack guidance and is based upon factors such as target activity, dwell time, and payoff compared to other targets currently being processed for engagement.

Attack guidance

2-112. The staff recommends and the commander approves attack guidance, distributing it via the attack guidance matrix. The guidance should detail when, how, desired effects, SPINS, and required BDA of the HPTL. The S-3 or FSO recommends the attack system for each target. All attack assets, including ground forces, should be considered. The attack should optimize the capabilities of—

- Ground and special operations assault forces.
- Helicopters.
- Armed UAS.
- Indirect fire assets—artillery, mortars, naval surface fire support (NSFS).
- Engineers-counter mobility, helicopter- and artillery-delivered mines, and external transport of small earthmovers.
- CAS and air interdiction.
- AD artillery.
- Cruise missiles.
- EW.
- Psychological operations (PSYOPS).
- Civil affairs (CA).
- Deception.

Attack criteria

2-113. Effects refer to target or objective attack criteria. The S-3/FSO specifies attack criteria according to higher headquarters guidance. Target criteria should be given in quantifiable terms. Criteria may be expressed as a percentage of casualties, destroyed elements, time on target (TOT), duration of fires,

number of tubes or launchers, allocation or application of assets. If ground forces are required to achieve the desired effects, the size of force, time on the ground, extraction, and linkup plans must be determined. Additionally, the S-3/FSO should identify accuracy or time constraints, required coordination, limitations on amount or types of ammunition, use of ground forces, and BDA requirements. For units working alongside attack reconnaissance helicopter elements, table 2-4 outlines preferred weapons for anticipated targets.

Table 2-4. Munitions selection

Preferred Munition	Types of Targets
Missile, radar frequency (RF) Hellfire	Heavy armor, wheeled vehicles, helicopters, slow-moving fixed-wing (FW) aircraft, other hard targets. Used when minimizing exposure is essential for survival.
Missile, semiactive laser Hellfire	Heavy armor, bunkers, cave entrances, helicopters, slow-moving FW aircraft, other hard targets. Used when a good line of sight (LOS) to target is available and to conserve RF missiles.
Missile, Blast Frag Hellfire	Naval craft, buildings, heavy equipment, light armor, and weapon caches. Warhead has a delay fuse with lethal fragmentation and incendiary pellets upon detonation.
Missile, Stinger	Helicopters, slow-moving FW aircraft.
Cannon, 30-mm high explosive dual purpose	Lightly armored targets, personnel, materiel and helicopters.
Machine Gun .50-caliber ball	Personnel, materiel, and unarmored vehicles.
Machine Gun, .50-caliber tracer	Observation of trajectory, incendiary effect, and signaling.
Machine Gun, .50-caliber, armor piercing	Light armor, shelters, and similar bullet resistant targets.
Machine Gun, .50-caliber, incendiary	Hardened or armored targets to ignite flammable material.
Machine Gun, .50-caliber, armor piercing incendiary	Combined effects of armor piercing and incendiary rounds.
Rocket, high explosive	Materiel, personnel, light armor, and wheeled vehicles.
Rocket, high explosive multi-purpose submunition	Light armor, wheeled vehicles, materiel, personnel, fighting positions, and strong points.
Rocket, flechette	Personnel, unarmored vehicles, and helicopters.
Rocket, illumination	Battlefield illumination, shut-down of enemy night vision devices (NVDs).
Rocket, white phosphorous (smoke)	Target marking, incendiary.

Assess

2-114. Combat assessment is the determination of overall effectiveness of force employment during military operations. It is composed of the following three major components:

- BDA.
- Munitions effectiveness assessment.
- Reattack recommendation.

2-115. BDA is the timely and accurate estimate of damage resulting from application of military force and accomplishes the following:

- Provides commanders with snapshots of their effectiveness on the enemy and an estimate of the enemy’s remaining combat effectiveness, capabilities, and intentions.
- Provides essential information for determining if reattack is required.

2-116. Munitions effectiveness assessment occurs concurrently with BDA and is the basis of recommendations for changes to increase effectiveness of—

- Method and timing of attack.
- Tactics.
- Weapons systems.
- Munitions.
- Weapon delivery parameters.

2-117. Reattack and other recommendations should address operational objectives relative to the following:

- Target.
- Target critical elements.
- Target systems.
- Enemy combat force strengths.

SECTION III – COMPANY COMMAND AND CONTROL

COMPANY COMMAND POST

2-118. The company CP is an austere setup and not specifically designed to be a staff level planning and tracking environment. The bulk of the company's mission information comes from the battalion, BCT or air assault task force (AATF). The company CP is for company specific mission planning, briefings and rehearsals. Often, the company CP is collocated within the same shelter grouping as the company's maintenance and supply personnel offering limited space designated specifically for mission planning. The company CP operates under the same principles as the main CP.

SPLIT-BASED OPERATIONS

2-119. Operations of platoons/sections independent of the company headquarters is referred to as split-based operations. Modularity of forces supporting BCTs requires companies to operate while geographically separated and with a decentralized command. Company headquarters may be collocated with their platoons or the platoons may be deployed forward in support of a BCT, ATF, or TF. Companies must be able to deploy, sustain combat operations, and fight wholly or as independent platoons or sections. The duration depends on mission requirements and will require sufficient logistics support. Additional augmentation of personnel and/or equipment may be required to fill essential mission support roles.

CAPABILITIES

2-120. Aviation company capabilities are a combat multiplier for the ground tactical commander. Modularity of companies allow for a "plug and play" capability for BCTs, ATFs, and TFs. Aviation companies are capable of 24-hour continuous operations for short periods of time. Sustained operations involving surges, such as in an offensive operation, will require the unit to have a reduced capability, following the operation, for the period of time required to accomplish maintenance on aircraft and manage fighter endurance for aircrews. The aviation modular design allows corps and theater assets to reinforce brigade assets which provide an added capability to reinforce BCTs, ATFs, and TFs during surge operations. This design also provides aviation support following surge operations, while the BCT's, ATF's, and TF's organic aviation unit companies are in a reduced capability time frame.

ATTACK RECONNAISSANCE COMPANY ELEMENTS

Commander

2-121. The company commander is a warfighter, responsible for the integration of his company into the combined arms fight. He leads, mentors, guides, and inspires the Soldiers of the company. He is a highly proficient aviation leader and is qualified as a PC in accordance with TC 1-210. The commander is responsible for training platoon leaders and evaluating crews and individuals as well as assessing training. The company commander is responsible for aircraft maintenance ensuring aircraft are available to meet the battalion commander's intent. He also determines crew selections as well as composition of flight teams. The 1SG, platoon leaders, IPs, TACOPS, and PCs assist the commander in ensuring crews are combat ready.

First Sergeant

2-122. The 1SG is the senior NCO and senior enlisted aviation maintainer at company level. The 1SG is the commander's primary advisor concerning enlisted Soldiers and performs other duties directed by the commander. The 1SG focuses attention on functions critical to success of the operation. The 1SG assists the commander in the following ways:

- Provides recommendations and expedites procurement and preparation of enlisted replacements for the company.
- Supervises daily maintenance operations.
- Organizes, deploys, and supervises all support elements assigned, attached, or OPCON to the company. This includes food service, transportation, maintenance, and other support personnel.
- Coordinates medical, mess, supply, administrative, and other logistics support.
- Receives, consolidates, and forwards all administrative, personnel, and casualty reports to battalion rear CP via radio, hard copy, or digital format.
- Establishes and organizes the company resupply point.
- Leads company ground movements when required and establishes AAs.
- Monitors NCO development, promotions, and assignments. This includes assessment of the company's battle focused Soldier and NCO leader training programs.
- Identifies, plans, and assesses Soldier performance on training tasks supporting collective (unit) tasks on the METL.

Platoon Leader

2-123. The platoon leader leads his platoon in combat and is responsible for crew selection recommendations and mission accomplishment. Unit IPs assist the platoon leader in ensuring crews are properly selected and trained. Platoon leaders are expected to develop proficiency in the aircraft and attain the designation of air mission commander (AMC) and PC, while ensuring crews are proficient in TTP. The platoon leader is responsible for all maintenance operations of the platoon to include—

- Updating the commander on all aircraft status changes.
- Developing and implementing a tracking system to monitor critical maintenance services, such as—
 - Scheduled maintenance.
 - Unscheduled maintenance.
 - Deferred maintenance.
 - Phases/progressive preventive maintenance.
 - Flow chart.
 - Status chart.
 - Parts and work order requests.
- Supervising daily maintenance operations.

Platoon Sergeant

2-124. The platoon sergeant is the key assistant and primary adviser to the platoon leader. He provides advice concerning enlisted Soldiers, and performs other duties directed by the platoon leader. The platoon sergeant assesses Soldier training proficiency with input from section leaders identifying Soldier and collective tasks needing training. The platoon sergeant assists the platoon leader, as the 1SG assists the commander, by—

- Ensuring platoon has aircraft available to accomplish assigned missions.
- Providing recommendations and requesting, through the platoon leader to the commander, procurement and preparation of enlisted replacements for the company.
- Coordinating medical, mess, supply, administrative, and other logistics support for the platoon.

- Reviewing maintenance forms ensuring crew chiefs verify deficiencies and completing additional forms as necessary.
- Ensuring submittal of maintenance forms and appropriate tracking is initiated.
- Monitoring status of replacement parts, including parts on order and valid parts requisition numbers.
- Ensuring all recoverable parts are turned in.
- Leading platoon ground movements and conducting preexecution checks when required.
- Providing input to platoon leader's collective task assessment.
- Ensuring Soldiers are prepared for and attend training.
- Monitoring NCO development and promotions.
- Identifying, planning, and assessing Soldier performance on training tasks supporting individual and collective (unit) tasks on the METL (to include maintenance tasks).

Standardization Instructor Pilot

2-125. SPs assist the commander in developing and implementing the unit aircrew training program (ATP). He also assists the commander in crew selection, normally performs as a member of the company operations planning cell, and may serve as an AMC during combat operations. SPs provide quality control for the ATP via the commander's standardization program. Along with their primary responsibilities, they mentor and professionally educate all unit crewmembers. SPs are tasked to provide expertise on unit, individual, crew, and collective training to the commander and perform the following functions:

- Serves as member of the battalion standardization committee.
- Advises commander on development of commander's task list (CTL).
- Monitors unit standardization and ATPs.
- Maintains unit individual aircrew training folders (IATFs).
- Monitors unit no-notice programs.
- Assists battalion SP and battalion master gunner in the development and execution of realistic company gunnery tables. This may include ammunition forecast, helicopter gunnery skills test, engagement scenarios, situational training exercises (STXs), and computer-based ASE training (CBAT) requirements.
- Develops company STXs accurately reflecting current combat operations and the full spectrum of aircraft capabilities.
- Attends training meetings.

Instructor Pilot

2-126. IPs are responsible for assisting the platoon leader in properly training combat ready crews. IPs provide quality control for the ATP via the commander's standardization program. Although IPs work directly for the platoon leader, they receive guidance and delegated tasks from the company SP. This ensures training is standardized throughout the company, provides for an economy of effort in the company, and contributes to professional development of the IP. Along with their primary responsibilities of the standardization program, they mentor and professionally educate all unit crewmembers. IPs are also responsible for—

- Performing as designated (IP and/or instrument examiner).
- Conducting no-notice evaluations.
- Assisting company standardization officer in maintaining IATFs.
- Assisting in development of company STXs.
- Assisting in development and execution of company gunnery tables.
- Assisting the company SP and TACOPS in development of the CTL.

Unit Trainer

2-127. Unit trainers are aviators designated to instruct in areas of specialized training (see TC 1-210). They assist IPs in unit training programs and the achievement of established training goals. Some areas in which they instruct are—

- Night vision goggles (NVGs).
- Instrument flight.
- Tactics.
- Border and corridor qualifications.
- Local area qualifications.

Maintenance Test Pilot

2-128. MPs assist the commander as the primary advisor for developing and managing the unit maintenance program. The MP must be involved in all day-to-day maintenance aspects of the company, coordinating required resources as necessary ensuring their efficient use. The MP's ultimate goal is ensuring maximum availability of aircraft. The MP also—

- Conducts maintenance test flights and maintenance operational checks.
- Advises commander, platoon leader, and platoon sergeant on maintenance operations.
- Serves as an operational mission pilot.
- Conducts pilot training on maintenance related subjects and troubleshooting fundamentals.

Safety Officer

2-129. SOs assist the commander in developing and implementing all unit safety programs. An SO is not just an observer; he is expected to be tactically and technically proficient, and an active participant in the ATP. Commanders rely on their SOs to monitor all safety aspects of the unit, and provide feedback and advice from a different perspective than that of the commander. The SO serves as the commander's advisor on risk management during flight mission planning. SOs are the commander's primary trainer for annual safety training requirements and composite risk management, including—

- Individual risk assessment.
- Crew risk assessment and mitigation.
- FARP and AA site surveys.
- Convoy risk assessment and safety briefs.

Tactical Operations Officer

2-130. TACOPS officers are the subject matter experts in the field of threat, aviation survivability measures, and for the organic AMPS and its associated products. Additional responsibilities include—

- Conducting the ASE/EW portion of the risk management process.
- Assisting in development of unit TTP.
- Assisting the battalion TACOPS in managing the organization's PR program.
- Determining ASE settings and countermeasures.
- Advising the commander and company leaders on appropriate ASE techniques and procedures, and if necessary, coordination for integration of joint assets for each major mission.
- Integrating FS and CAS into company mission planning.
- Managing/tracking company ASE systems.
- Assisting in development of company STXs and company gunnery tables.
- Advising commander on development of CTL.

Aviation Life Support Officer

2-131. Aviation life support officers (ALSOs) assist, advise, and represent commanders in all matters pertaining to the aviation life support system (ALSS). ALSOs—

- Review, analyze, and develop procedures ensuring planning, budgeting, and maintenance of ALSS.
- Ensure training of aircrew personnel in proper operation, use, and operator maintenance of survival equipment and techniques of survival.
- Supervise the life support section and ensure qualified personnel are available to conduct life support and survival training and maintenance of organizational level aviation life support equipment (ALSE).
- Maintain a current file of regulations, procedures, and technical manuals (TMs) pertaining to inspection, maintenance, and use of assigned life support equipment.
- Ensure units have adequate information and training before using new equipment or system changes.
- Ensure materiel deficiency reports are submitted on life support equipment failing to operate as designed.

2-132. Additionally the commander will appoint ALSE technicians and specialists to assist, advise, and represent the aviation life support officer (ALSO) in all matters pertaining to ALSE. Technicians—

- Establish a library of ALSE publications and ensure the unit's pinpoint distribution account is updated to include ALSE publications and necessary forms.
- Ensure all ALSE is maintained in a high state of readiness by inspecting, cleaning, fitting, testing, adjusting, and repairing equipment.
- Maintain files on inspection, maintenance, expiration dates, and supply pertaining to ALSE.
- Inspect all controlled drugs used in survival kits and vests.

Company Armament Maintenance Officer

2-133. The armament maintenance officer oversees maintenance of the aircraft weapons systems, their configuration, and loading and unloading of arms.

COMPANY PLANNING CONSIDERATIONS

TROOP LEADING PROCEDURES

2-134. Although the MDMP is essential to accomplish the mission, effective TLP are equally important. Commanders with a coordinating staff use the MDMP. Company-level and smaller units do not have formal staffs and use TLP to plan and prepare for operations. Figure 2-2, page 2-31, depicts TLP along with key planning tasks. The box on the left shows the steps of TLP. The box in the middle (METT-TC) represents the initial METT-TC analysis that leaders conduct to develop an initial assessment. This occurs in steps 1 and 2 of TLP and is refined in plan development. The box on the right depicts plan development tasks. Plan development occurs in steps 3 through 6 of the TLP. These tasks are similar to the steps of the MDMP (see FM 5-0, chapter 3).

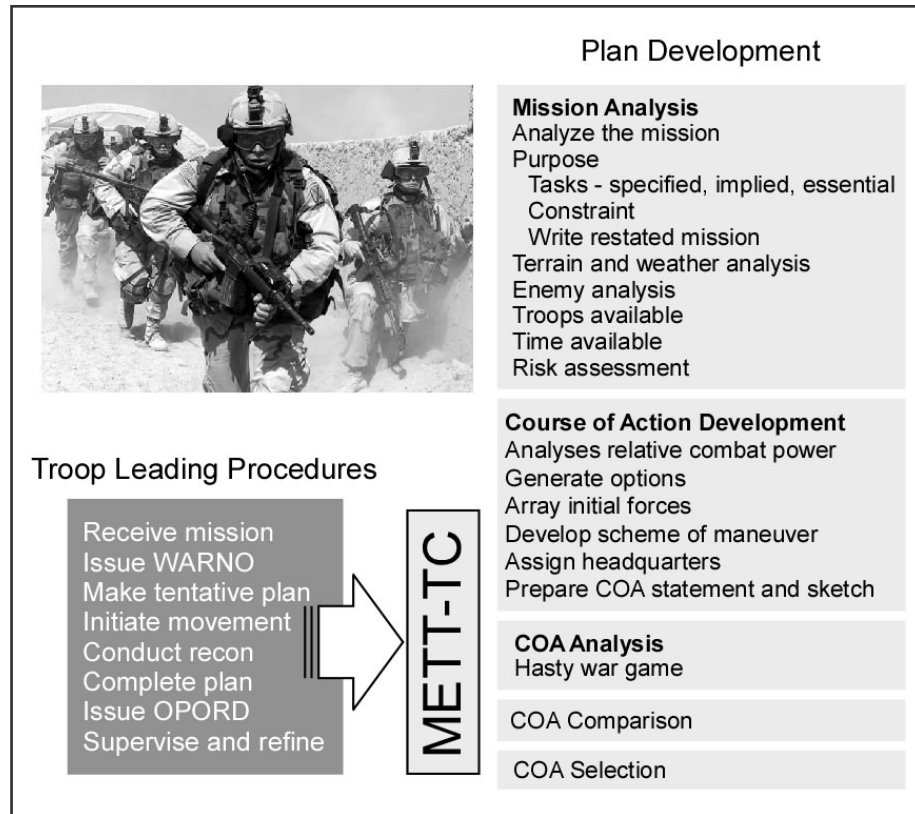

Figure 2-2. Troop leading procedures and key planning tasks

2-135. TLP must be a part of SOP and checklists within that SOP. Although quick directives can accomplish much in certain circumstances, a missed step can easily lead to mission shortfalls or failure. Written TLP steps provide a guide the leader applies in ways consistent with the situation, leader's experience, and experience of subordinate leaders.

2-136. Leaders use TLP when working alone to solve tactical problems or with a small group. A company commander may use his 1SG, platoon leaders, SP and SO to assist during TLP. Additionally, aviation company commanders utilize planning cells to perform much of the TLP process.

PLANNING CELLS

2-137. Company planning cells are utilized by the commander to plan, organize, and effectively execute the mission. This section defines a method for planning conducted at company level and the process a company follows to ensure completion of required tasks for mission planning.

2-138. The company commander or senior officer acts as the mission AMC. He selects crews and assigns them to planning cells. The AMC assigns suspense for planning cells providing products to the reproduction/distribution cell.

Process

2-139. The following process establishes information requirements necessary to successfully plan and execute company missions. Cells conduct planning concurrently. The information required for planning and execution is the receipt of WARNO. To begin planning, the following information is needed from a WARNO:

- Threat and friendly situation along routes and AO.*
- Mission, objective or target time, and any alternate missions.
- Weather and light data for time of operation.
- Number of aircraft required.
- Location of specified passage points (PPs) or corridors with occupying unit designation, call-sign and frequency.*
- Specific tasks for planning cells.
- Time and place of OPORD.
- AMPS integration.
- Cell assignments matrix (table 2-5).

Note: *These items are available on AMPS disk. The battalion may provide companies with AMPS generated mission data in conjunction with the WARNO/OPORD. The goal is providing mission graphics such as control measures, friendly situation, enemy situation, etc.

Table 2-5. Example cell assignments matrix

<p>Route Planning Cell</p> <p>Operate AMPS:</p> <ul style="list-style-type: none"> ● Select air control points (ACPs), altitudes, airspeeds, and formations using friendly situation graphics. Coordinate with other units as necessary. ● Calculate/confirm time, distance, and heading (TDH) data. All grid coordinates and TDH data will be double checked by another member of the cell. ● Identify obstacles and hazards. Coordinate with weather/hazards cell. ● Coordinate with ASE/EW cell to avoid known enemy hazards. ● Coordinate with operations cell concerning mission time-line. ● Produce/update AMPS mission graphics to include flight plan, control measures, battlefield graphics, and mission essential data. ● Provide reproduction/distribution cell with kneeboard products. ● Load mission from AMPS to data transfer cartridges (DTCs) and provide to all copilots at briefing.
<p>Communications Cell</p> <p>Develop communication sets for the mission. Ensure COMSEC equipment in all mission aircraft (including spares) is keyed and operational. This includes KY-58, KIT 1C, SINGARS and Have Quick. Collect frequency and IFF data from the OPORD, ACO, aviation procedure guide, automated net control device (ANCD), SOP and flight information publication covering all aspects of the mission from communications check to mission completion. Prepare the unit communications card. Provide the reproduction/distribution cell with all data in a timely manner.</p>
<p>Performance Planning Cell</p> <p>Obtain mission load data. Obtain planning weather data (temperature and pressure altitude). Prepare a generic performance planning card (PPC). Calculate fuel-planning data for all phases of the mission. If unit aircraft are equipped with auxiliary tanks, perform planning for those aircraft allowing for contingencies (such as auxiliary tanks do not transfer fuel). Calculate a minimum fuel for mission. Minimum fuel required (including VFR reserve) for the aircraft to return to the FARP or AA (commonly code worded as "bingo").</p>

Table 2-5. Example cell assignments matrix

Place all calculations and data on the unit PPC/fuel planning card and provide the route planning cell and reproduction/distribution cell with all data in a timely manner.
<i>Operational Planning Cell (usually composed of commander and team leader/leaders)</i>
Produce company mission timeline (includes team and FARP rotation plan). Selection of target reference points (TRPs). Selection of attack by fires (ABFs), support by fires (SBFs), and OPs. Control measures for routes and/or zones. Team employment procedures. Integration into ground tactical plan. Provide the reproduction/distribution cell with all data in a timely manner. Conduct contingency planning. Brief actions on the objective at the unit mission briefing.
<i>Weather, Notices to Airmen, Hazards Cell</i>
Compare forecasted weather and mission requirements. Be sure to take into consideration illumination, sunrise/sunset times. Review notices to airmen (NOTAMs), air advisories and ACO for any items that may influence the mission. This includes IIMC recovery airfields. Update wire hazards map. Provide the reproduction/distribution cell with all data in timely manner. Brief weather, NOTAMs, and hazards at the unit mission briefing.
<i>Flight Plan/Mission Brief/Risk Assessment Cell</i>
Complete the mission brief and risk assessment sheets and make them available to mission crews prior to mission briefing. Inform the AMC if initial risk assessment warrants any amendments to the mission profile. Complete the flight plan or collect data for flight operations log. Obtain squawk codes, PPRs and diplomatic clearances as required by mission. Provide the reproduction/distribution cell with all data in timely manner.
<i>Inadvertent Instrument Meteorological Conditions Cell</i>
Develop an IIMC recovery plan for the mission. On missions with long en route portions, more than one recovery airfield may be required. Select appropriate instrument approach procedures at each recovery airfield. Create emergency GPS recovery procedure if required. Prepare an IIMC plan and post on unit IIMC card. Obtain FARP layout data and post on unit FARP sketch. Provide the reproduction/distribution cell with all data in timely manner.
<i>Threat Cell/ASE/ EW</i>
Analyze threat composition, disposition, order of battle, array and numbers. Using AMPS inter-visibility plots, analyze threat weapons systems that may influence the mission. Coordinate with route planning cell concerning any threats that may influence the unit during the en route phase. Coordinate with the operations cell concerning any threats in the vicinity of the objective. Prepare the threat risk assessment. Much of the data for this form may be obtained from the Air Force tactics, techniques, and procedures (AFTTP). The AFTTP is a classified document and may be obtained from the TACOPS/ battalion/squadron EWO/S-2. Provide the reproduction/distribution cell with all data in timely manner. Brief the threat risk assessment at the unit mission briefing.

Table 2-5. Example cell assignments matrix

<i>Reproduction/Distribution Cell</i>
<p>Actively collects and safeguards all data provided by planning cells.</p> <p>If a photocopy machine is available, reproduce packets for all crewmembers. All packet items will be uniform if possible, arranged in the same order and paper-clipped together.</p> <p>Post the mission briefing boards as soon as possible. This will allow aircrews to post their own mission packets if reproduced packets are not available.</p> <p>Distribute packets prior to start of mission briefing.</p> <p>Assist AMC with preparation for the mission briefing. This includes posting graphics/overlays to briefing maps.</p> <p>Products which are reproduced and distributed:</p> <ul style="list-style-type: none"> • Route cards. • FARP, Objective, and EA sketches. • Communication card. • PPC. • FS card. • Weather, NOTAMs, and hazards briefs. • Flight plan/mission brief/risk assessment. • IIMC recovery plan. • Threat risk assessment. • Mission execution matrix (if not provided from battalion).

SECTION IV – MEETINGS AND BRIEFINGS

OPERATIONS ORDER BRIEF

2-140. The OPORD briefing provides information, specific instructions, and a thorough overview of the mission. The briefing is usually presented by a single briefing officer, who may be the commander, an assistant, a staff officer, or a special representative depending on the nature of the mission or the level of the headquarters. See FM 5-0 for more information on orders production and briefings.

2-141. In an operational situation or when the mission is of a critical nature, individuals or smaller units may need more specific data, which may be provided by a mission briefing. The mission briefing reinforces orders, provides more detailed requirements and instructions for each individual, and explains the significance of each individual role.

2-142. The briefing should be organized to follow the written order's format.

AIR MISSION BRIEF

2-143. The AMB is a focused adjunct to the OPORD where the ARB commander approves the plan. The term AMB is used to mean both the written product and the briefing itself. The AMB should not be a working meeting. An OPORD should have already been published. Therefore, the AMB is essentially a backbrief to the commander. All units involved in the operation should attend and receive a copy of the order.

2-144. The AMB should focus on attack reconnaissance concepts, sequence of events, and the reasons the staff developed the sequence for the mission. The slightest change in route selection, ABFs/SBFs, or other elements of the mission can significantly affect the rest of the plan. The CAB staff will play a pivotal role in the AMB process.

2-145. Changes to the mission after the AMB must be approved by the commander. It is very difficult to resynchronize the different combat systems in the short time that remains between the AMB and mission execution. Unit personnel attending should bring—

- Air mission checklist.
- Maps.
- Execution matrix.
- ANCD for receiving frequency set changes/updates.
- AMPS DTC for receiving changes/updates to routes.

2-146. Briefing products produced may include—

- Mission.
- Friendly graphics
- A2C2 procedures.
- Communication card (frequencies/call signs).
- Execution matrix.
- Routes (AMPS cartridge).
- ANCD frequency set load.
- Risk assessment/mission brief/mission schedule.

TEAM BRIEF

2-147. Team briefs can occur at different levels. The team can be briefed by the battalion or company for specific missions or missions in larger operations. An example of this is teams being briefed by battalion for missions supporting battalion PR or QRF operations. Information and products reviewed during the brief include—

- PPC.
- FS card.
- Actions on contact.
- Contingency planning.
- Scheme of maneuver.
- Battle handover (BHO) procedures.
- Weather, NOTAMs, and hazards briefs.
- Flight plan/mission brief/risk assessment.
- IIMC recovery plan.
- Threat risk assessment.

CREW MISSION BRIEF

2-148. The PC briefs the mission and flight requirements demanding effective communication and proper sequencing and timing of actions according to a unit approved crew mission brief checklist. The appropriate aircraft type aircrew training manual (ATM) contains an example of a detailed crew mission briefing checklist and instructions for completing this task. Unit SOPs should address crew briefing checklists.

SECTION V – REHEARSALS

2-149. A rehearsal is essential for success in operations. FM 6-0 contains a discussion of rehearsal types, techniques, responsibilities, and conduct. Following is a discussion of items critical to aviation operations.

2-150. Once commanders are satisfied and personnel understand the concept of operation, they must rehearse the plan. The rehearsal cannot become the brief to commanders. The purpose is to validate synchronization of subordinate units' tasks to execute the commander's intent.

2-151. Rehearsal types include—

- Confirmation brief.
- Backbrief.
- Combined arms rehearsal.
- Support rehearsal.
- Battle drill or SOP rehearsal.

2-152. Rehearsal techniques include—

- Full dress rehearsal.
- Reduced force rehearsal.
- Terrain model rehearsal.
- Sketch map rehearsal.
- Map rehearsal.
- Network rehearsal.

2-153. Although a full dress rehearsal is preferred, a terrain model rehearsal is the most common technique. The terrain model must represent the unit's area of influence and be large enough for participants to easily traverse. An effective rehearsal is dependant upon an accurate terrain model, complete with key terrain features, reliefs, obstacles, and unit positions (friendly and enemy) correctly portrayed. Additionally, an effective technique for utilizing terrain models is to increase the scale of the objective area for better visualization by rehearsal participants. A standardized terrain model kit is an effective tool to reduce setup time.

2-154. Rehearsals are accomplished at all levels. They may be conducted separately at each echelon, in one large rehearsal, or using a combination of the two. An appropriate large rehearsal would be a cross-forward line of own troops (FLOT) IA. Rehearsals are as detailed as time and resources permit. They may be a series of full-up, live-fire rehearsals or as simple as a quick review on the map. All rehearsals must include reviewing or conducting the following:

- Actions on the objective.
- Maneuver, movement, and fires.
- Critical event rehearsals (such as FARP and egress).
- Contact drills en route.
- Contingencies.

REHEARSAL SEQUENCE AND ATTENDANCE

2-155. Rehearsals follow a script and proceed in action, reaction, counteraction sequence. Elements of the script include—

- Agenda.
- Attendee response sequence to actions.
- Unit actions response checklist (standardized format).
- Sequence of events.

2-156. If time becomes critical during the rehearsal, then the most critical part of the mission must be given adequate attention. Rehearsals must include a representation of the enemy and should cover—

- Actions on the objective.
- Enemy positions and disposition.
- Friendly scheme of maneuver/ground tactical plan.
- Integration of FIRES/suppression of enemy air defense (SEAD).

- Actions on contact.
- Occupation of reconnaissance or security positions, battle positions (BPs), and landing plans.
- Passage of lines.
- Flight plans including primary/alternate routes, ingress/egress procedures at the objective, maneuver formations, flight techniques, and altitudes.
- Actions in the AA (out-front boresight, communication checks, line up for takeoff, takeoff, landing upon return).
- Ammunition loads and FARP information.
- CASEVAC procedures.
- IIMC procedures.
- In stride/immediate downed aircrew recovery procedures.
- Contingency plan TTP (such as change of mission and aircraft equipment malfunction).

2-157. All critical members of units should attend the rehearsal. Critical members are those who have key parts in the operation and whose failure to accomplish a task could cause mission failures.

REHEARSAL QUESTION RESOLUTION

2-158. The battalion commander and staff may conduct the rehearsal or observe it. Regardless, detailed questions ensure units executing the mission thoroughly understand it, and battalion has accomplished its planning. The following questions are examples of critical questions that should be answered during the rehearsal:

- What are contingencies at the objective for various enemy actions?
- Who is responsible for calls for fire and who do they call?
- Who has clearance of fires authority by phase and in which zones?
- Who provides rear or flank security?
- Who collects and sends SPOTREPs, whom do they call, and on which net?
- Who initiates fires for the attack?
- Where do crews get the time sequencing for Have Quick (unless automatic)?
- Who is talking to the Air Force for JAAT operations?
- Who initiates communications checks?
- Who coordinates with the ground force commander?
- Who confirms call signs, nets, and authenticators?
- What radio calls (digital and voice) are required during the conduct of the operation?
- What are the success criteria, and how do we know if they have been met?
- What are the mission criteria, and who selects these criteria?
- What are the divert criteria and who makes that decision?
- What are the mission abort criteria?
- What are the in-stride downed aircrew procedures?
- What are the CASEVAC procedures?
- What are the ROE?
- What are the ASE requirements and settings?
- What are the critical times (PP, TOT, RP)?
- Who makes BDA reports, to whom, and when?
- What is the bump and spare aircraft plan?
- Where are FARPs, and what are the procedures?

CONFLICT RESOLUTION AT THE REHEARSAL

2-159. Conflicts may arise during a rehearsal. The commander must ensure conflicts are resolved, and the rehearsal does not become a wargame. Wargaming should have been accomplished during the planning process. The rehearsal ensures all members of the unit understand their roles and how they contribute to success. It is not the time to develop a new plan, but if required, refinements may be made.

ADDITIONAL REHEARSALS

2-160. The communications exercise (COMMEX) should mirror the signal requirements of the mission. The COMMEX ensures assignment of nets, equipment capabilities, range, RETRANS requirements, and COMSEC requirements. All elements participating in the mission participate in the COMMEX. The use of a common communications card is highly recommended and allows for a quick reference guide to frequencies and call signs.

2-161. Company rehearsals are required to cover key company events not portrayed at the battalion rehearsal, such as formation, bump plan, departure sequence, radio calls, and actions on the objective. Attendees include all aircrews and key leaders.

REHEARSAL COMPLETION

2-162. At the end of any rehearsal the commander should receive correct responses from every member present concerning—

- The mission/actions at the objective.
- The commander's intent.
- The timetable for mission execution.

2-163. Following rehearsal and prior to executing the mission, commanders conduct PCIs to ensure PCCs on aircraft and mission equipment are complete.

PRECOMBAT CHECKS

2-164. Aircrews and vehicle operators conduct PCC. Checks include—

- Posting graphics on maps.
- Completing aircraft performance planning.
- Preflight/before operations preventive maintenance checks and services (PMCS).
- Ensuring proper configuration of vehicles, aircraft, and weapons systems.
- Ensuring DTC upload.
- Ensuring IFF is loaded.
- Ensuring COMSEC is loaded.
- Verifying communications checks.
- Test firing of weapons systems, if possible.

SECTION VI – END OF MISSION DEBRIEFING AND AFTER-ACTION REVIEW

DEBRIEFS

MISSION DEBRIEF

2-165. Units should address mission debrief procedures in their SOP. They should conduct mission debriefs as soon as practical upon completion of the mission. All mission personnel should attend. Mission debriefs cover mission planning, preparation, and execution phases. The purpose is to capture what happened during a mission to ensure all requirements were achieved. The intent is to capture better

SA/understanding and intelligence of the area. Table 2-6, page 2-39, shows an example mission debrief format.

Table 2-6. Sample mission debrief

Date:	
Time:	
Mission:	
Location:	
AMC:	
Aircraft #1: Call sign and crew	
Aircraft #2: Call sign and crew	
	Takeoff time
	Route
	Actions on objective
	Significant events
	SPOTREPs
	BDA
	Priority intelligence report (PIR) answered
	FARP/team rotations
	BHO/end of mission time
Maintenance: Hours flown and thorough postflight analysis of the aircraft	
SAFIRE Incidents:	
	A/C location
	A/C heading, altitude, and airspeed
	Evasive maneuvers performed
	Enemy
	Weapon system/# of rounds
	Enemy location
	Number of personnel
	Subsequent actions

TEAM

2-166. Platoons and sections operating independently from company headquarters (in support of BCT for example) conduct the same debriefs and are responsible for submitting information to the S-2/S-3 and platoon's/section's respective commander.

COMPANY

2-167. Commanders ensure unit personnel conduct mission debriefs as soon as practical upon completion of the mission, with all mission personnel attending. Mission debriefs cover mission planning, preparation, and execution phases with a focus on how to improve the operation. Additionally, the commander ensures the higher headquarters S-2/S-3 receives debrief information and is afforded the opportunity to debrief the crew if warranted.

BATTALION S-2/S-3

2-168. The front line Soldier is another extremely valuable intelligence source. Commanders instill in crew members they are reconnaissance Soldiers fighting for and confirming intelligence. Their sightings and reporting of any activity (or lack thereof) may make the difference between victory and defeat. The S-2 debriefs aircrews as an essential part of gathering information. The crews provide the S-2 with all sketches, checklist and video imagery collected during the mission.

AFTER-ACTION REVIEW

PURPOSE

2-169. An after-action review (AAR) is a structured review process of an event, focused on performance standards, enabling Soldiers to discover for themselves what happened, why it happened, and how to sustain strengths and improve future operations. It is a tool that leaders and units can use to obtain maximum benefit from every mission or task. The AAR consists of the following four parts:

- Review what was supposed to happen (training plan).
- Establish what happened.
- Determine what was right or wrong with what happened.
- Determine how the task should be done differently next time.

2-170. Unit AARs focus on individual and collective task performance, identifying shortcomings and training required to correct any deficiencies. AARs with leaders focus on tactical judgment. These AARs contribute to leader learning and provide opportunities for leader development. AARs with trainers, evaluators, observer controllers, and opposing forces provide additional opportunities for leader development. See FM 7-1 for more information.

2-171. If applicable, AARs are forwarded to the next higher headquarters S-3. Commanders should emphasize what they believe to be key critical elements within the AAR.

Application to Future Missions Training

2-172. Each AAR has a direct impact on the next mission or training event. Commanders review and annotate recommendations from AARs. The commander can then implement recommendations he feels are necessary to enhance mission execution and safety. The commander ensures all leaders (officer and NCO) review the AAR with his comments posted. These include improvements to the SOP, TTPs, battle drills and, at a minimum, include mission critical elements. This allows officers and NCOs to learn from the AAR and understand the commander's guidance on recommendations.

2-173. Following the reviews and commander's guidance, the recommendations are highlighted in planning the next mission or training event. Following the mission or training, the debrief covers the results of an implemented recommendation. The commander reviews the outcome and determines if he wants to continue as recommended or modify the recommendation for a better outcome.

Chapter 3

Employment

This chapter addresses employment of the attack reconnaissance battalion. The ARB is a versatile organization that can conduct offensive operations and support defensive, stability, and civil support operations. The ARB conducts offensive operations through movement to contact and attack, and supports all missions through tactical enabling operations such as reconnaissance and security. FARP operations and aviation maintenance are aviation specific tactical enablers that allow the ARB to sustain mission support.

SECTION I – INTRODUCTION

3-1. Principles for employment of aviation assets follow these general guidelines—

- Fight as an integral part of the combined arms team.
- Exploit capabilities of other branches and services.
- Capitalize on intelligence-gathering capabilities.
- Suppress threat weapons and acquisition means.
- Exploit firepower, mobility, and surprise.
- Mass forces.
- Use terrain for survivability and concealment.
- Displace forward elements frequently.
- Maintain flexibility.

3-2. The primary missions of the ARB, ARS, and ACS are reconnaissance, security, movement to contact, and attack to facilitate ground maneuver. Each company must be prepared to fight as a part of the battalion as a whole, as part of an ATF, or independently in support of a BCT.

3-3. The battalion is often used as a shaping force. ARBs are maneuver units that can dominate, but not occupy, terrain for limited periods. The ARC fulfills traditional AH, as well as reconnaissance and security, responsibilities. Advanced sensors, communications equipment, and weaponry enable both independent operations and operations in concert with ground or joint forces. The ARC is effective against massed moving targets, point targets (cave entrances, bunker apertures, windows in buildings), and other hard or soft targets. The ARC enables the commander to mass combat power rapidly shaping the operational environment.

Contents	
Section I – Introduction.....	3-1
Section II – Team Employment.....	3-2
Section III – Reconnaissance	
Operations	3-10
Section IV – Security Operations	3-30
Section V – Attack Operations	3-58
Section VI – Movement To Contact.....	3-87
Section VII – Personnel Recovery	
Operations	3-88
Section VIII - Stability and Civil	
Support Operations	3-95
Section IX – Urban Operations	3-95
Section X – Quick Reaction Force	
Operations	3-114
Section XI – Passage of Lines and	
Battle Handover.....	3-116
Section XII – Air Combat Operations ...	3-120
Section XIII – Deception Operations	3-120

SECTION II – TEAM EMPLOYMENT

3-4. ARCs and ARTs normally organize into teams for TACOPs to gain increased flexibility of employment; team driven operations are the basic building block for many aviation combat operations conducted by companies. Platoon and company formations are generally comprised of multiple lead/wingman teams. Each team should be prepared to assume duties of other teams during missions. The type of flight mode and movement technique is based on METT-TC.

SCOUT WEAPONS TEAM EMPLOYMENT

3-5. Scout weapons teams (SWTs) are normally comprised of a lead and a wingman. Lead is generally the most proficient PC in the team and is selected based on ability and demonstrated knowledge of missions, tactics, and local SOPs. This position does not interfere with the normal command and control the mission. It does allow the most experienced PC to maneuver the team and engage using proper tactics, formations and weapons delivery techniques as directed by the AMC. The wingman's primary responsibility is to cover the lead aircraft. In addition, the wingman is generally the commander, platoon leader, or senior warrant officer who serves as AMC. The AMC provides critical tactical leadership and decision making and is overall responsible for the team/flight.

3-6. Table 3-1 defines composition and responsibilities of SWTs. These tasks are not all inclusive and task assignment may be changed by the AMC due to METT-TC or unit SOP. It is important to note that team roles and responsibilities (other than AMC) can change numerous times during the mission.

Example: The trail aircraft may assume tactical lead when they are the first aircraft to locate the enemy and need to execute immediate actions on contact. The length of time and degree to which aircraft roles and duties are reversed are a factor of METT-TC and unit SOP.

Table 3-1. Team tasks

Team Tasks	
Executes forward and left/right sector security as appropriate for team formation.	
Clears route using visual/sensors forward, left and right of centerline.	
Transmits alerts for obstacle avoidance.	
Executes basic combat maneuvers (BCMs) as required to engage or bypass threats (See TC 1-201).	
Transmits target reports to wingman/flight.	
Designates with laser for other teams, if required.	
Conducts attacks or suppression of air defense units (ADUs).	
Maintains briefed separation from lead and other teams.	
En route Tasks	
Lead	Wing
Primary for selecting routes and tactics employed.	Provides cover/security for lead and C2
Provides precise navigation and timing.	Provides backup navigation and timing.
Conducts destruction of ADUs or selection of bypass route for team and flight.	Provides destruction of AD for team and flight covers lead.
Coordinates direct fire engagements with the ground forces.	Makes initial contact with ground forces and prioritizes engagements.
Updates AMC on status of the mission. (Timeline, estimated time of arrival [ETA])	Conducts PP coordination.
Objective Area Tasks	
Selects appropriate method of attack	Provides calls for fire.
Selects appropriate ordinance for weapon target pairing.	Identifies, prioritizes and distributes target assignments within the team.

Table 3-1. Team tasks

Selects appropriate attack pattern for target	Conducts BHO with relieved/relieving team.
Acts as primary target designator.	Conducts coordination for CAS, joint surveillance target attack radar system, and artillery.
Executes as primary shooter for CCA.	Receives targeting data from lead and delivers ordinance to assigned targets.
Gives attack brief to wingman and flight if required.	Receives targeting data from lead and delivers ordinance to assigned targets.
	Provides fire remote ordinance for other teams, if required.
	Provides updates to commander with current situation, ammunition status, and EA status.

3-7. SWTs comprised of OH-58Ds and AH-64s perform missions using the same principles as ARC and ART pure teams with minor changes in TTP and lead/wingman roles (table 3-2). These changes are necessary to maximize the strengths and reduce the inherent weaknesses of each airframe. The overall affect of this pairing combines the reconnaissance and air-ground integration capability of the OH-58D with the superior firepower of the AH-64.

Table 3-2. OH-58D/AH-64 Scout weapons team tasks

Objective Area Tasks	
OH-58D	AH-64
Perform AMC duties.	Primary shooter.
Controls movements of the SWT and focuses on reconnaissance objective	Protect OH aircraft
Provide situation updates to the commander	Maintain continuous observation of OH
Conduct target handover and marks targets for AH aircraft	Provide contact guidance to OH if first to locate threat
Coordinate with and maintain SA with ground forces	Receive target handover, determine and announce attack method and pattern
Conduct BHO	Provide situation awareness to scout

TEAM MANEUVERING

3-8. When different types of aircraft operate in a formation, the operating procedures, characteristics, and limitation of each type must be evaluated. Additionally, when aircraft are mixed at night, differences between NVG, forward-looking infrared (FLIR), and external lighting must be identified and considered in planning. Inconspicuous use of IR chemical lights or tape, IR strobes, and/or IR position lights allows easy identification and improved spatial reference.

3-9. Maneuverability is a prime consideration for SWTs when performing TACOPs. The following formations allow lead to maintain formation integrity, yet maneuver with few restrictions. Wingmen must maintain a position that will not hamper lead’s ability to maneuver while providing their own horizontal and vertical clearance. Variations in altitude may be advantageous based on METT-TC. The high-low concept in conjunction with the movement technique may provide more flexibility to the team, especially in the urban environment. Wing may increase his altitude commensurate with the threat to utilize the potential energy of altitude to build airspeed during a diving attack. This provides a more stable gun platform and greater maneuverability for egress off the target.

3-10. Over open terrain or during high illumination, greater spacing is used to increase survivability and flexibility. Formation spacing becomes tighter in rough terrain or reduced illumination/visibility. It is important to avoid flying over the same spot on the ground; variations in flight path between aircraft/teams should be the norm. The mission dictates aircraft separation and team separation. Aircraft and team separation may range from 3-5 rotor disks to 1 kilometer or more (figure 3-1, page 3-4). Primary concern when establishing separation is METT-TC and the ability to provide mutual support. The basic SWT

formations are combat cruise, combat cruise left and right, and combat spread. These formations can be enlarged and modified as necessary to accommodate platoon and company missions.

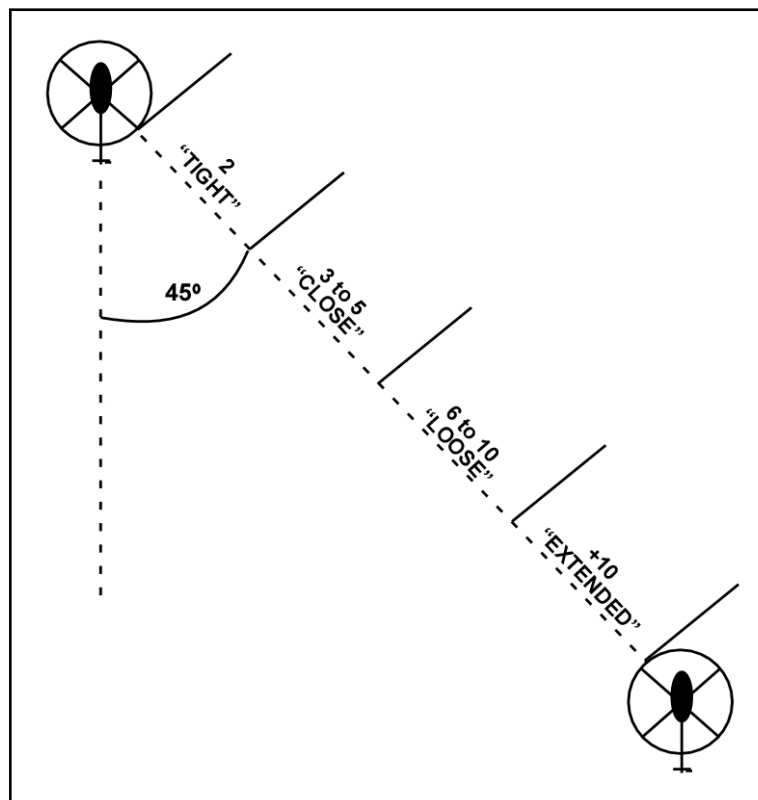

Figure 3-1 Formation separation

COMBAT CRUISE

3-11. Combat cruise is used when teams wish to move quickly and maximize use of terrain for masking. Combat cruise allows the wingman flexibility in maneuvering the aircraft left or right of the lead aircraft's centerline. The wingman should never track in straight trail as it limits forward observation and the ability to provide suppressive fires for lead. It also increases the possibility that the lead's presence has alerted the enemy to the wingman's flight path. Separation should be 150 meters or more depending on terrain and threat (figure 3-2, page 3-5).

3-12. Combat cruise formation is—

- Preferable at very low altitudes for long flights breaking up the predictability of the formation and permitting optimal terrain flight using masking terrain.
- Preferable during day and high visibility weather when small arms fire threat is substantial.
- Standard formation for SWT employment.

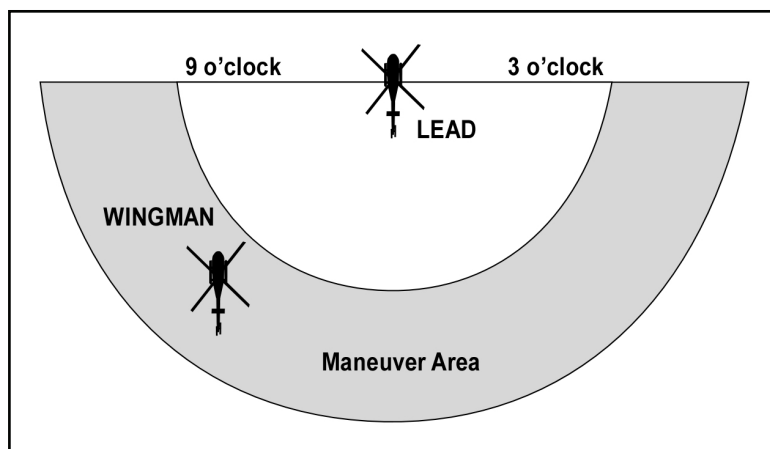

Figure 3-2. Combat cruise

Combat Cruise Right/Left

3-13. Unlike combat cruise, combat cruise right/left requires the wingman remain in either right or left cruise and change sides only after coordinating with the lead aircraft. Using combat cruise right/left, the wingman remains in an arc 0 to 90 degrees aft abeam of lead to the left or right side. Optimum position is 45 degrees. Separation should be 150 meters or more depending on terrain and threat. Observation sectors are divided between lead and wing providing overlapping observation and fire (figure 3-3).

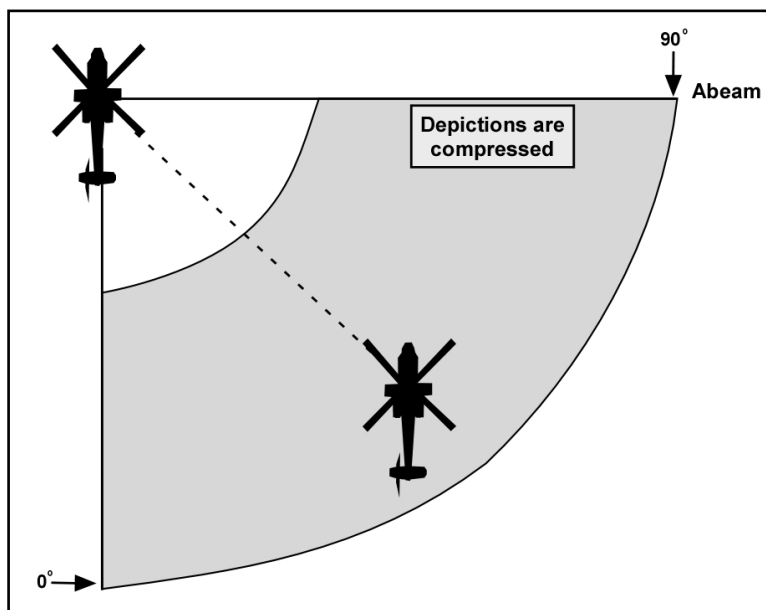

Figure 3-3. Combat cruise right (depicted)

3-14. Combat cruise right/left formation—

- Is preferable at very low altitudes for long flights breaking up predictability of formation and permitting optimal terrain flight using masking terrain.
- Is preferable to combat cruise when weather and night vision systems are marginal, but threat is still high.
- Can be used at night for larger formations as an alternative to echelon when NVG are used.

Combat Spread

3-15. Combat spread promotes security by providing maximum firepower forward and overlapping fields of view (FOVs). When flight lead announces combat spread, he includes the command left or right. Wingmen should move toward that abeam position, either lead's 3 or 9 o'clock position. Flying in combat spread requires a rapid scan to maintain SA of the other aircraft as well as approaching terrain; this requires even more vigilance at night. For planning, the wingman should maintain approximately ten rotor disk separation from the lead aircraft. Team leaders may vary the maximum lateral separation between aircraft based on visibility, maneuver space available, and expected enemy weapon ranges (figure 3-4).

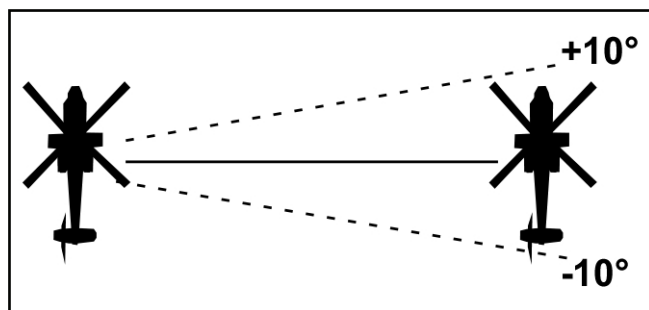

Figure 3-4. Combat spread

3-16. Combat spread formations—

- Can be used when maximum observation to the front is desirable or when attempting to limit exposure of the flight when crossing open areas.
- May be used en route to minimize vulnerability of trail aircraft.
- Are not advised for use in the objective area when constant maneuvering is required.
- Increase pilot workload to maintain formation, especially under night vision systems.

PLANNING CONSIDERATIONS

3-17. The factors considered in determining the best formation, or sequence of formations, are—

- Mission of supported and aviation units.
- Current enemy situation, enemy AD capability and placement, and vulnerability to enemy visual or electronic surveillance.
- Weather and environmental conditions such as ceiling and visibility, wind and turbulence, ambient light levels, and IR crossover throughout the mission.
- Artillery support available, NSFS, planned types of ordnance, and en route J-SEAD.
- Possible changes in mission or situation and evasive tactics to be used.
- Type of NVDs used.
- Level of crew training and experience.
- Aircraft capabilities.

FLIGHT MODES AND MOVEMENT TECHNIQUES

3-18. Flight modes include low-level, contour, and nap-of-the-earth (NOE). They are often referred to as terrain flight. Based on METT-TC, all three modes of flight can be combined during the execution of missions.

3-19. Movement techniques include traveling, traveling overwatch, and bounding overwatch. Movement techniques are designed to exploit mobility of helicopters while employing fire and maneuver concepts.

3-20. Security is established and maintained by adapting the flight to specific flight modes and movement techniques according to METT-TC. Flight modes and movement techniques incorporate principles of overwatch which include—

- Locating the enemy with a minimum of forces.
- Using all available cover and concealment.
- Overwatching lead elements and preparing to fire and maneuver.
- Adjusting movement technique and type of terrain flight to factors of METT-TC.

3-21. Teams choose flight mode and movement technique based on available terrain and probability of enemy contact. Battalion or TF S-3s recommend terrain flight modes and movement techniques based on IPB; however, companies refine this information during TLP choosing the appropriate scheme of maneuver for assigned mission(s).

TERRAIN FLIGHT

Terrain Flight Mission Planning and Preparation

3-22. Using elements of METT-TC is essential to the safe and successful accomplishment of missions at terrain flight altitudes. Consistent with commander's intent, flight routes, holding areas (HAs), and ABFs/BPs are determined and planned accordingly. Contingency planning is also a critical element during this stage of the operation, including alternate flight routes, alternate HAs, hazards (both flight and threat) and suspected enemy positions. The entire planning sequence is a methodical and thorough effort, eliminating confusion and clarifying each step in the planned execution phase. This intensive level of preparation also better prepares each aircrew to react to changes, unexpected events, and emergencies. This planning phase must include appropriate personnel from the next lower level of operation ensuring adequate dissemination of information and mission accomplishment.

3-23. The rapid dissemination of information allows maximum planning and familiarization time by aircrews. It also permits maximum time to brief the mission and address the body of questions and inquiries that inevitably result. There must be a sense of urgency in expediting the flow of information to aircrews as quickly as possible.

3-24. Essential planning for terrain flight may include—

- Analyzing the mission using the factors of METT-TC.
- Performing a map/photo reconnaissance using the available map media, AMPS video map terminal, or photos (ensure all known hazards to terrain flight are plotted on the map or into the AMPS).
- Selecting the appropriate terrain flight modes.
- Selecting appropriate primary and alternate routes and enter them on the map, route sketch, or into the AMPS.
- Determining distance, ground speed, and estimated time en route (ETE) for each leg of the flight.
- Obtaining and evaluate weather briefing.

3-25. Terrain flight planning and preparation also include aircraft preparation to ensure aircraft are configured, preflighted and readied for the ensuing mission. This is most effectively accomplished with a timely and continuous information flow from higher headquarters, such as battalion S-3.

Terrain Flight Limitations

3-26. Terrain flight imposes additional factors on aircrews and units not encountered on missions flown at higher altitudes. The following are considerations for missions at terrain flight altitudes:

- Mountainous or uneven terrain restricting use of LOS radios, making it difficult or sometimes impossible to conduct normal communications.

- In terrain flight operations, control may be delegated to a lower level due to inherent problems. Aircrews and platoon, section, or team leaders must be knowledgeable enough to execute the mission using sound tactical judgment. This is a result of training and experience.
- IEDs/vehicle-borne improvised explosive devices (VBIEDs), wires, towers, and thrown objects can have effects on aircraft flying over or too close to roads.

3-27. Such missions should be coordinated with higher headquarters ensuring appropriate airspace management and acquiring the latest intelligence updates. Even in a training scenario, the plan to conduct terrain flight operations must be disseminated ensuring safe use of the training area.

3-28. The unit anticipates increased maintenance as a result of increased demands placed on aircraft and components.

3-29. Demands on aircrews increase dramatically when terrain flight operations increase, especially NVD terrain flight. Specifically, fighter management becomes a larger issue with an increase in psychological and physiological stress. The factors increasing stress include—

- Increased workloads (physical dexterity and mental processes).
- Limited FOV when using NVD.
- Reduced visual acuity, viewing distances, and depth perception.
- More complex aircrew coordination.

Modes of Terrain Flight

3-30. Terrain flying includes appropriate tactical application of low-level, contour, and NOE flight techniques as appropriate, diminishing the enemy's capability to acquire, track, and engage aircraft. Terrain flight requires aircrew proficiency in map reading, preparation, and terrain interpretation. It also requires constant vigilance in identifying terrain features and hazards, and understanding effects of surrounding terrain, ambient light, and seasonal changes in vegetation. Continuous NOE or contour flight is unusual because terrain and vegetation vary. Normally, there is a transition from one mode to the other as the situation dictates. Modes of terrain flight are defined below.

Nap-of-the-earth flight

3-31. NOE flight is conducted at varying airspeeds as close to the earth's surface as vegetation and obstacles permit. Aviators should decrease airspeed if weather and ambient light restrict visibility.

Contour flight

3-32. Contour flight is conducted at low altitude conforming to the earth's contours. It is characterized by varying airspeeds and altitude, dictated by the terrain and obstacles. Aviators should decrease airspeed if weather and ambient light restrict visibility.

Low-level flight

3-33. Aviators perform low-level flight at constant altitude and airspeed, dictated by threat avoidance. Aviators should decrease airspeed if weather and ambient light restrict visibility.

Selection of Terrain Flight Modes

3-34. Companies must determine which terrain flight mode to use in each segment of the planned route during the mission planning sequence. This determination is based on METT-TC.

Mission

3-35. The mission influences selection of terrain flight techniques. This is especially true if the company performs the mission at night. Factors such as light levels and moon illumination complicate NVD flight at terrain flight altitudes. The lack of visual acuity may demand a lower airspeed and higher altitude.

Enemy

3-36. Threat weapons can detect and engage aircraft at low altitudes. To avoid or minimize detection, the company must select the appropriate terrain flight mode.

Terrain and weather

3-37. Vegetation and terrain features masking an aircraft from visual and electronic detection significantly degrade the capability of threat weapons to detect an aircraft. The company determines a maximum safe flight altitude by availability of terrain features and vegetation to mask the aircraft. Companies use the highest terrain flight altitude for a specific condition. A higher flight altitude reduces difficulty in navigation, permits a higher airspeed, reduces hazards to terrain flight, and minimizes fatigue.

3-38. Periods of deteriorating weather with low ceilings/restricted visibility may make any of the terrain flight modes extremely difficult or impossible. These weather conditions also make navigation more difficult and increase potential for IIMC, especially when flying in formation or operating in an unfamiliar environment.

Troops

3-39. Personnel factors may affect selection of terrain flight techniques. These may include aircrew availability, experience level, and effects of the fighter management program.

Time

3-40. Time also influences selection of the terrain flight mode. Whenever possible, the route should be flown at the highest flight mode to permit the shortest completion time.

Civilian considerations

3-41. The selection of a particular mode must consider the safety of and potential threat from any civilian sector. Consideration must also be given to the disturbance of civilians. An attack reconnaissance team conducting security for a civilian event may become detriment to the mission on the ground.

MOVEMENT TECHNIQUES**Traveling**

3-42. Company elements employ traveling technique to move rapidly through the operational environment when enemy contact is unlikely, or the situation requires speed for evading the enemy. All aircraft move at the same speed. This technique is the fastest method for aircraft formation movement, but provides the least amount of security. Units often employ low-level and contour flight at high airspeeds using the traveling movement technique.

Traveling Overwatch

3-43. Company elements employ traveling overwatch when speed is essential and enemy contact is possible. This technique is normally associated with reconnaissance, security, and attack missions when threat and/or environmental conditions preclude use of bounding overwatch. Lead aircraft or teams move constantly and trail aircraft or teams move as necessary maintaining overwatch of lead. Overwatching aircraft key their movement to terrain and their distance from the main element. It also remains ready to fire or maneuver, or both, providing support to main elements. Units often employ contour or NOE flight with the traveling overwatch technique using high and varying airspeeds depending on weather, ambient light, and threat.

Bounding Overwatch

3-44. Company elements employ bounding overwatch when they expect enemy contact and the greatest degree of concealment is required. It is the slowest movement technique; too slow for high tempo

operations and vulnerable for nonlinear and/or urban operations. Individual aircraft or aircraft teams employ alternate or successive bounds.

3-45. One element remains in position to observe, fire, or maneuver before the other element moves. Overwatching elements cover the progress of bounding elements from a covered and concealed position, which offers observation and fields of fire against potential enemy positions.

3-46. The length of the bound depends on terrain, visibility, and effective range of the overwatching weapon system. Units normally employ contour and NOE flight with bounding overwatch technique. Airspeed during each bound is varied depending on availability of vegetation and terrain for concealment.

MANEUVERING FLIGHT

3-47. In addition to terrain flight, NOE tasks, and hovering engagements, aviators must be well versed in maneuvering weapons employment techniques such as running fire and diving fire. These TTP require Army aviators to be intimately familiar with aerodynamics and maneuvers associated with high energy weapons platform employment. These skills are required to support engagement of a distributed enemy in complex terrain.

3-48. Combat maneuvers should only be used as required to accomplish the mission. Units should incorporate training programs to develop combat maneuvering skill sets as well as define the factors of METT-TC that precipitate the need for transition to high energy tactics. AMCs or flight leads identify and brief changes in flight profile based on threat and mission changes. See TC 1-201 for more information.

SECTION III — RECONNAISSANCE OPERATIONS

3-49. Reconnaissance is a focused collection effort that produces combat information. Commanders frequently task the battalion with conducting reconnaissance to obtain, by visual observation or other detection methods, information about enemy activities and resources or about the meteorological, hydrographic, or geographic characteristics and the indigenous population of a particular area. Reconnaissance is performed before, during, and after other combat operations to provide information used by the battalion or ground force commanders to confirm or modify the plan.

3-50. ARBs gather and report the information on which the ground force commander bases plans, decisions, and orders. An ARC is ideally suited for reconnaissance operations due to the TA capability of onboard systems, the aircraft's armament, and extended range of communications. Reconnaissance missions are divided into four categories—route, zone, area, and surveillance. Companies may be assigned any combination of the four categories of reconnaissance missions. In most mission profiles, integration of ground and attack reconnaissance aircraft provides mutual reinforcement. For example, ground units may reinforce attack reconnaissance aircraft if the terrain offers concealment from aerial observation. However, close coordination and continuous communication between forces is critical to reduce the risk of fratricide. The distance the ARC operates from the supported unit is a function of METT-TC, but generally is forward enough to provide the ground commander time to maneuver before enemy direct fires can be brought into effect.

3-51. Reconnaissance missions focus on reconnaissance objectives and set strict criteria for engagement and developing the situation in conjunction with ground forces and supporting fires. Supporting fires include indirect fire and joint fires. Nonlethal J-SEAD and EW assets should also be considered and employed whenever available. These assets support the ARC during reconnaissance operations; their availability is essential to the success of ARCs.

3-52. Commanders need real-time information during the execution of current operations to be precise in the maneuver and application of combat power against the enemy. A major source of near real-time information is the ARC, which is an intelligence source that can fight for information. Attack reconnaissance aircraft have decisive advantages over other intelligence resources because they—

- Move quickly over inaccessible terrain to elevated positions of advantage.
- Use advanced, eyes-on, long-range sensors.

- Work through and may be able to counter enemy deception efforts better than any sensor system.
 - Provide the fastest, most reliable means of assessing terrain the enemy is trying to configure to its advantage.
 - Are not a passive source. Aircraft not only find the enemy but can further develop the situation and force the enemy to reveal more information.
 - Can more effectively disseminate information to commanders with an immediate need.
- 3-53. Types of useful information the ARC can supply to higher headquarters in near real-time includes—
- Actual size, disposition, and composition of the enemy.
 - Areas of strength and weakness.
 - Current enemy activity.
 - Where and when the precise application of superior combat power could have a decisive effect.
 - Best route to an objective.
 - Location of friendly forces.

FUNDAMENTALS

3-54. Reconnaissance is the precursor to all operations and may be accomplished through passive surveillance, technical means, human interaction, or by fighting for information (see FM 3-20.96 for more information). Successful reconnaissance operations are planned and performed according to the following seven reconnaissance fundamentals:

- Gain and maintain enemy contact.
- Orient on the reconnaissance objective.
- Report all information rapidly and accurately.
- Retain freedom to maneuver.
- Develop the situation rapidly.
- Ensure maximum reconnaissance force forward.
- Ensure continuous reconnaissance.

GAIN AND MAINTAIN ENEMY CONTACT

3-55. Contact is any condition ranging from an initial sighting during surveillance to physical contact while engaging in close combat. Contact reduces the threat's ability to achieve surprise. The degree of contact desired is determined before the mission begins. Once contact is made, it is not voluntarily broken; orders must be received to break contact or be defined in the bypass criteria of the OPOD. To do otherwise could risk the survival of the unit because gaining and regaining contact are inherently risky endeavors. The threat or location must be continuously monitored until the requirement is met or contact is handed over from one observer to the next. Attack reconnaissance aircraft report information immediately and continually update the commander on the tactical situation. ARCs may maintain visual contact from a distance, or it may engage with company aircraft or supporting fires.

ORIENT ON THE RECONNAISSANCE OBJECTIVE

3-56. Orient on the location or movement of the reconnaissance objective. The objective may be a terrain feature, control measure, locality, or a threat force. Aerial reconnaissance orients on the objective and positions itself to retain freedom of maneuver. Units remain focused on reaching the reconnaissance objective regardless of what is encountered during the mission. When time, unit capabilities and limitations, or threat action prevents a unit from accomplishing all the critical tasks for a particular form of reconnaissance, the unit uses the reconnaissance objective to focus the reconnaissance effort. If the threat force is moving, the unit adjusts the scheme of maneuver to maintain orientation on the threat.

REPORT ALL INFORMATION RAPIDLY AND ACCURATELY

3-57. Attack reconnaissance units work to report all information rapidly and accurately. Delayed, inaccurate, or misdirected information may lead to missed opportunities or poor decisions. Information that initially appears unimportant may become valuable when combined in context with other data. ARCs must acquire and report accurate and timely information on the threat, civil considerations, and terrain and weather that could impact friendly operations. Knowing a threat force is not in one location can be just as important as knowing it is in another. Combat information is extremely time sensitive; information loses its relevance as it ages.

RETAIN FREEDOM TO MANEUVER

3-58. ARCs must retain the ability to maneuver to successfully complete their missions. The ARC obtains information by stealth when possible, but fights as necessary to accomplish the mission. Overwatch, suppressive fires, cunning, and constant awareness of the tactical situation help retain freedom to maneuver. Decisive engagement occurs when the company is fully committed and cannot maneuver or extricate itself. If the ARC is decisively engaged, reconnaissance stops and a battle for survival begins. Attack reconnaissance teams must have clear commander's guidance concerning engagement, disengagement, and bypass criteria that support the maneuver commander's intent. To prevent decisive engagement, teams must employ proper movement and reconnaissance techniques, and use overwatching fires and SOPs. Initiative and knowledge of both the terrain and threat reduces the likelihood of decisive engagements and helps maintain freedom of movement. Prior to initial contact, the ARC adopts a combat formation designed to gain contact with the enemy with the smallest friendly element possible. This provides the company with the maximum opportunity for maneuver and enables it to avoid having the entire unit become decisively engaged. The IPB process can identify anticipated areas of likely threat contact. Using indirect fires to provide suppression and obscurity, as well as to neutralize or destroy point targets, is a technique ARCs use to retain their freedom of maneuver.

DEVELOP THE SITUATION

3-59. While conducting reconnaissance, ARCs frequently encounter tactical situations requiring immediate actions on contact and rapid situation development. These tactical dilemmas may concern terrain obstructions or threat activities. If an obstacle is encountered, the attack reconnaissance unit must determine the type and extent of the obstacle, and whether it is covered by fire. Obstacles can provide information concerning the location of threat forces, weapon capabilities, and organization of fires. If a threat force is encountered, the ARC determines its size, composition, disposition, activities, and movement. In most cases, the attack reconnaissance team developing the situation immediately employs actions on contact by deploying to cover, reporting, maintaining observation, and developing the situation. Reconnaissance techniques, often in the form of battle drills, are used to rapidly develop the situation to maintain tempo and not relinquish the initiative to the threat. The ARC develops the situation based on the OPORD, unit SOP, or the commander's intent. There are situations based on attack guidance and terrain when it may be more appropriate to immediately develop the situation (for example, conduct a direct fire engagement) rather than deploy to cover.

ENSURE MAXIMUM RECONNAISSANCE FORCE FORWARD

3-60. Attack reconnaissance assets are most valuable when providing essential operational environment information. The optimal number of intelligence-gathering assets should be employed in the reconnaissance effort. To do this, the assets must be positioned as far forward as METT-TC, combat support, and sustainment factors allow with maximum UAS integration. This does not mean company assets are always arrayed in a linear fashion. Depth is essential, especially in restricted terrain or a contaminated environment.

ENSURE CONTINUOUS RECONNAISSANCE

3-61. Effective reconnaissance is continuous and conducted before, during, and after all operations. Moreover, maintaining continuous reconnaissance is critical during transition operations. Before an operation, reconnaissance focuses on filling gaps in information about the threat and terrain. During an operation, aerial reconnaissance focuses on providing updated information verifying the enemy's composition, dispositions, and intentions as the battle progresses. This allows the ground force commander to verify which COA is actually being adopted by the threat and determine if his plan is still valid based on actual events in the AO. After an operation, aerial reconnaissance focuses on maintaining contact with the threat to determine its next move and collecting information necessary for planning subsequent operations. As a minimum, reconnaissance is conducted continuously as an integral part of all security missions, including the conduct of local security for forces not in contact.

3-62. Extended operations, both distance and duration, require ARC commanders to develop crew rest plans to maintain a continuous reconnaissance effort. All company assets, to include Soldiers and systems, used in the reconnaissance effort need time for rest, resupply, TLP, and maintenance services and checks. The commander must determine not only where, but also when, he will need his maximum reconnaissance effort and adjusts fighter management and maintenance plans to ensure adequate assets are available at critical times and places. Detailed and disciplined crew rest plans are critical to attack reconnaissance operations. To be effective, these plans must be nested with the current battle rhythm and enforced by the personal example and supervision of the company command group.

PLANNING CONSIDERATIONS

3-63. The ARC must receive additional detailed instructions beyond the reconnaissance objective, such as the specific tasks the higher commander wants accomplished or the priority of tasks. Higher commanders accomplish this when issuing commander's guidance and publishing instructions in the OPORD tasks to subordinate units. This guidance is an extension of the commander's intent and is designed to focus the ARC commander's efforts in relationship to the battalion mission. The higher commander's essential reconnaissance guidance should, as a minimum, include—

- Focus.
- Tempo.
- Engagement/bypass criteria.
- Air limits of advance (LOAs).
- Transition operations guidance.

RECONNAISSANCE FOCUS

3-64. The reconnaissance focus enables the company commander to determine the priority of tasks and specific critical tasks the company needs to accomplish. It allows the commander to narrow the unit's scope of operations to get the information most important to battalion or BCT operations. The focus might be terrain-oriented or threat-oriented. In stability operations or civil support operations the focus may be on local civilian sentiment or identifying local paramilitary leaders. While all critical tasks have some degree of applicability in any given operation, certain ones are more important for specific missions. This has to be clearly articulated. Given a specified amount of time, the company accomplishes its specified critical tasks, then accomplishes other tasks as directed by the higher commander.

3-65. The focus of the reconnaissance is clearly linked to answer CCIR, support targeting, and provide other relevant information. To determine the reconnaissance focus, commanders identify specific information requirements and indicators required to answer the CCIR. Reconnaissance is also focused to detect events that trigger targeting (both lethal and nonlethal effects). The focus may require reconnaissance to pull infantry or armor units to favorable locations for direct fire engagements. The focus may push reconnaissance to acquire HPTs for indirect fires. The focus may also require obtaining information to trigger employment of an attached CA team to contain a civil disturbance. Finally, in addition to links to CCIR and targeting, the reconnaissance focus may require the ARC to provide additional RI to fill information gaps, support C2, and support the higher headquarters scheme of

maneuver. In summary, the reconnaissance focus provides the purpose of assigned reconnaissance missions.

3-66. To answer CCIR, support targeting, and provide other RI in the current operational environment, reconnaissance focuses on more than just the threat and terrain. Regardless of the environment (cities, jungle, mountains, desert, densely forested hills, or coastal plain) or weather conditions, detailed, current, and accurate information about the terrain, threat, and increasingly societal and infrastructure factors is a must. Understanding the multiple dimensions of reconnaissance focus is paramount to the ARC performing reconnaissance in full spectrum operations. The dimensions of reconnaissance focus are outlined below in broad categories—terrain, threat, society, and infrastructure.

Terrain

3-67. Detailed and accurate knowledge of the ground, regardless of weather conditions, is a prerequisite to the operational and tactical success of any operation. To conduct effective offensive and defensive operations, as well as stability and civil support operations, combined arms commanders of conventional forces must know the current condition of highways, roads, trails, streets, alleys, buildings, bridges and underpasses, ford locations, and approaches that will support bridging operations. Commanders must know the locations and types of physical and manmade obstacles along a chosen path of maneuver, and the trafficability of the ground for suitability to support cross-country movement of dismounted and/or mounted forces.

3-68. A focused aerial reconnaissance provides a better terrain analysis than a map analysis normally. ARCs reconnoiter and analyze terrain as it pertains to both friendly operations and threat military operations. Terrain-focused reconnaissance evaluates the military aspects of the terrain (observation and fields of fire, avenues of approach, key terrain, obstacles and movement, and cover and concealment [OAKOC]) and provides valuable feedback to the commander on the feasibility of his scheme of maneuver. Reconnaissance also includes the effect of weather on the military aspects of the terrain. The side best understanding and exploiting effects of terrain has the greatest chance of success.

3-69. In the past, attack reconnaissance units have not focused on urban terrain. In fact, reconnaissance doctrine has focused on identifying bypasses around urban areas rather than reconnaissance in, over, under, and through them. Increased urbanization and the nature of asymmetric warfare suggest threat elements will use urban terrain in an attempt to mitigate the conventional superiority and exploit vulnerabilities of the United States. Today and in the future, ARCs must reconnoiter and analyze aspects of complex and urban terrain. They must analyze terrain not only in its traditional role, but also as it might apply in a stability or civil support environment as key terrain in these operations may be a religious or cultural monument or a historic geographical boundary or town.

Threat

3-70. Equally critical to the success of offensive and defensive operations, and to a degree, stability operations, is having detailed knowledge of the threat. Commanders must know the threat's size, strength, location, disposition, and supply condition. They must understand what the threat is postured to do and actually capable of doing relative to the terrain and existing weather conditions. Furthermore, commanders need to know the state of the threat and Soldiers' morale, strength of will, and determination to fight. This knowledge can only be gained by direct, physical contact with the threat and active capture and interrogation of prisoners. This information enables a commander to discern his opponent's strengths, weaknesses, and vulnerabilities. From this determination, he can decide when, where, and how to employ the power of his combined arms team and supporting joint/combined forces to accomplish his mission. Force protection is a byproduct of threat analysis.

3-71. The attack reconnaissance unit no longer faces a single, monolithic, or well-defined threat. During the cold war, planning centered on confronting numerically superior armored threats in Europe, the Far East, or southwest Asia. Today's ARC must be able to conduct full spectrum operations against threats ranging in size from major regional powers to asymmetric threats. The threat may include conventional forces, insurgents, paramilitary forces, guerrillas, criminal groups, certain civilian groups and individuals,

or a combination of all these forces. The threat no longer conforms to uniformly echeloned operations with disciplined formations and time-distance relationships. Potential adversaries may use a variety of hybrid doctrine, tactics, and equipment. It is extremely important to quickly identify the nature of the threat in a given operational area. Attack reconnaissance units will increasingly focus on determining the nature of the threat as opposed to just specific dispositions and locations. Threat-focused reconnaissance will have to also consider the impact of prevalent societal factors and indigenous infrastructures on the nature of the threat.

Society (Social/Human Demographics)

3-72. The reconnaissance focus, especially in stability and civil support operations may be the societal factors of the assigned AO. Gaining an awareness of how the society impacts military operations and how military operations impact the local society are critical to planning, appropriate and timely commander decisions.

3-73. The center of gravity during operations may be the civilian inhabitants themselves. To gain and/or retain the support of the population, commanders must first understand the complex nature and character of the society. Second, they must understand and accept that every military action (or inaction) may influence, positively or negatively, the relationship among the urban population, the threat and Army forces, and by extension, mission success. Without the support of the society or the understanding of its needs, the society may become a threat to United States military operations or may support threat operations. With this awareness, commanders can plan operations, implement programs, and/or take immediate action to maintain support of a friendly populace, or neutralize or gain the support of hostile or neutral factions.

3-74. Elements or factions of a society may be a threat to United States forces. A mob demonstrating against United States military presence could impact military operations and consequently be a specific focus for reconnaissance. Refugees clogging routes United States forces may want to use for combat operations can pose a threat. A focus may then be to identify these groups (and the leaders of these groups) allowing the commander to decide to use lethal or nonlethal effects to deal with the problem.

Infrastructure

3-75. The infrastructure is those systems that support the inhabitants and their economy and government. Destroying, controlling, or protecting vital parts of the infrastructure can isolate the threat from potential sources of support. Because these systems are inextricably linked, destroying or disrupting any portion of the urban infrastructure can have a cascading effect (either intentional or unintentional) on the other elements of the infrastructure.

3-76. To successfully operate in an area, the attack reconnaissance unit must understand the local infrastructure. The unit must understand it physically in terms of utilities, transportation, and food availability as well as the many other products that enable a community to operate. Units must also understand the local community, political, and governmental structure. This includes religious, military, and paramilitary, such as local security and police forces that work independently from one another. The company must develop a general understanding of these organizations—how they fit into the community at large and how they relate to one another. A reconnaissance mission focused on infrastructure considers these factors:

- **Communications.** Wireless, telegraph, radio, and television.
- **Transportation and distribution.** Highways and railways (to include bridges, tunnels, ferries, and fords); cableways and tramways; ports, harbors, and inland waterways; airports, seaplane stations, and heliports; and mass transit.
- **Energy.** Systems providing power to the urban area and consisting of industries that produce, store, and distribute electricity, coal, oil, and natural gas. This area also encompasses alternate energy sources such as nuclear, solar, hydroelectric, and geothermal.
- **Commerce.** Area includes business and financial centers (stores, shops, restaurants, marketplaces, banks, trading centers, and business offices) and outlying industrial/agricultural

features (strip malls, farms, food storage centers, and mills) as well as environmentally sensitive areas (mineral extraction areas and chemical/biological facilities).

- **Human services.** Includes hospitals, water supply systems, waste and hazardous material storage and processing, emergency services (police, fire, rescue, and emergency medical services), and governmental services (embassies, diplomatic organizations, and management of vital records, welfare systems, and the judicial system). The loss of any of these often has an immediate, destabilizing, and life-threatening impact on the inhabitants.

RECONNAISSANCE TEMPO

3-77. The established reconnaissance tempo enables the company to synchronize associated time requirements with unit battle rhythms, planning time, movement formations, and reconnaissance techniques. When developing the reconnaissance tempo, the commander should consider the following questions:

- What specific bypass criteria are acceptable in terms of risk and feasible considering the tempo of reconnaissance operations?
- Is it deliberate or hasty?
- How much time is allotted in the battlefield geometry to accomplish the reconnaissance mission?
- How will changing the tempo of the reconnaissance affect the information gathered (for example, a deliberate reconnaissance may require increased time for the team to gather required information on the objective while maneuvering for protection)?
- When does the main body initiate movement and how much time separation between them and reconnaissance forces is desired?

ENGAGEMENT CRITERIA

3-78. When developing engagement criteria, the company commander should consider the following questions:

- What are the ROE?
- What available lethal and nonlethal means are authorized and when?
- What is a company fight?
- What weapon system is used to engage what target type?

3-79. Engagement criteria establish what the company is expected to engage and what it is expected to hand over to the follow-on ground maneuver unit. Conversely, by understanding what the BCT requires/expects the company to engage, coupled with his understanding of the threat's most likely COA, the company commander is able to identify the company's engagement criteria. This enables the company commander to focus certain weapons systems or to develop EAs and plan for the destruction of specified threat elements if encountered.

Bypass Criteria

3-80. The higher headquarters commander establishes bypass criteria to control the tempo of operations and at the same time to mitigate force protection risks. Bypass criteria must be clearly stated and dependent on the factors of METT-TC. Frequently, the standard bypass criteria are not the same for BCTs and battalions. If the ARC is required to conduct a deliberate reconnaissance, then the bypass criteria are likely to be more restrictive. If the ARC is required to conduct a hasty reconnaissance, then the bypass criteria are likely to be more liberal.

LIMIT OF ADVANCE CRITERIA

3-81. Higher headquarters commanders need to carefully plan LOAs to take advantage of ARC capabilities and to facilitate transition to future operations. When developing the reconnaissance LOA, the commander should consider the following questions:

- Where is the BCT's coordinated fire line (CFL)? If possible, locate the LOAs so ARC can acquire indirect fire targets beyond the CFL.
- Is the LOA placed on terrain to optimize employment of ARC standoff acquisition and engagement systems?
- Is the LOA located to best enable transition operations?
- Are LOAs planned to extend TA and early warning?

TRANSITION OPERATIONS GUIDANCE

3-82. Often the endstate described in the higher headquarters commander's intent is focused on the endstate for the BCTs conducting decisive operations. Reconnaissance transition guidance is needed to provide a word picture of the endstate for reconnaissance. To conduct contingency planning, ARCs need to know what type of reconnaissance and security or other economy of force missions are anticipated to set conditions for successful transition and future operations. ARCs may continue with some form of reconnaissance or transition to a form of security—a screen to protect the main body during consolidation and reorganization. ARCs need to be prepared to assist in exploitation or pursuit operations. Commander's transition guidance for reconnaissance will focus future planning, especially concerning sustainment requirements.

RECONNAISSANCE TECHNIQUES

3-83. When tasked to conduct reconnaissance operations, the ARC can split its area into team zones depending on METT-TC. Use of waypoints on the aircraft's situational display to visually define the reconnaissance zone simplifies the reconnaissance effort. Use of the mast-mounted sight and TA designator sight to prepoint NAIs at maximum standoff and overwatch team/platoon/company members adds depth to the zone.

3-84. Because of its ability to conduct long range observation, the ARC is placed forward, and if possible, to the flanks of ground elements, adding depth to the commander's zone. To increase operational tempo, the ARC focuses its reconnaissance effort on areas that impede ground movement.

ACTIONS ON CONTACT

3-85. Actions on contact are a series of steps the company takes when it encounters a threat force or situation that warrants or demands action. Actions on contact are important because they allow the company to maintain its tempo of operation by rapidly developing the situation and taking action before the threat can gain the initiative and force the company to react. At company, platoon, or team level, actions on enemy contact consist of the following three steps:

- Deploy to cover and report.
- Maintain contact and develop the situation.
- Choose a COA.
- Recommend or execute a COA.

3-86. While the team that makes contact executes actions on contact, the commander must continue to maneuver the remainder of the unit to ensure a clear picture of the enemy situation across the entire unit front. The following steps demonstrate the actions taken by the team in contact.

Deploy to Cover and Report

3-87. **Scout weapons team action.** The team that makes initial contact with the threat immediately conducts basic combat maneuvering, suppresses as necessary, and deploys to terrain that affords them both cover and good observation. It may not always be possible to deploy to cover and maintain observation, especially in complex terrain. Depending on METT-TC, the team may have to continuously maneuver to maintain contact and develop the situation. Figure 3-5, page 3-18, displays a basic technique for maintaining contact during various reconnaissance or area security operations. The tactical lead orients on the objective and develops the situation while the wingman provides cover. Teams vary their pattern,

speed, and altitude as necessary depending on obstacles and threat. As soon as possible, the commander/team leader should send a SITREP to higher headquarters.

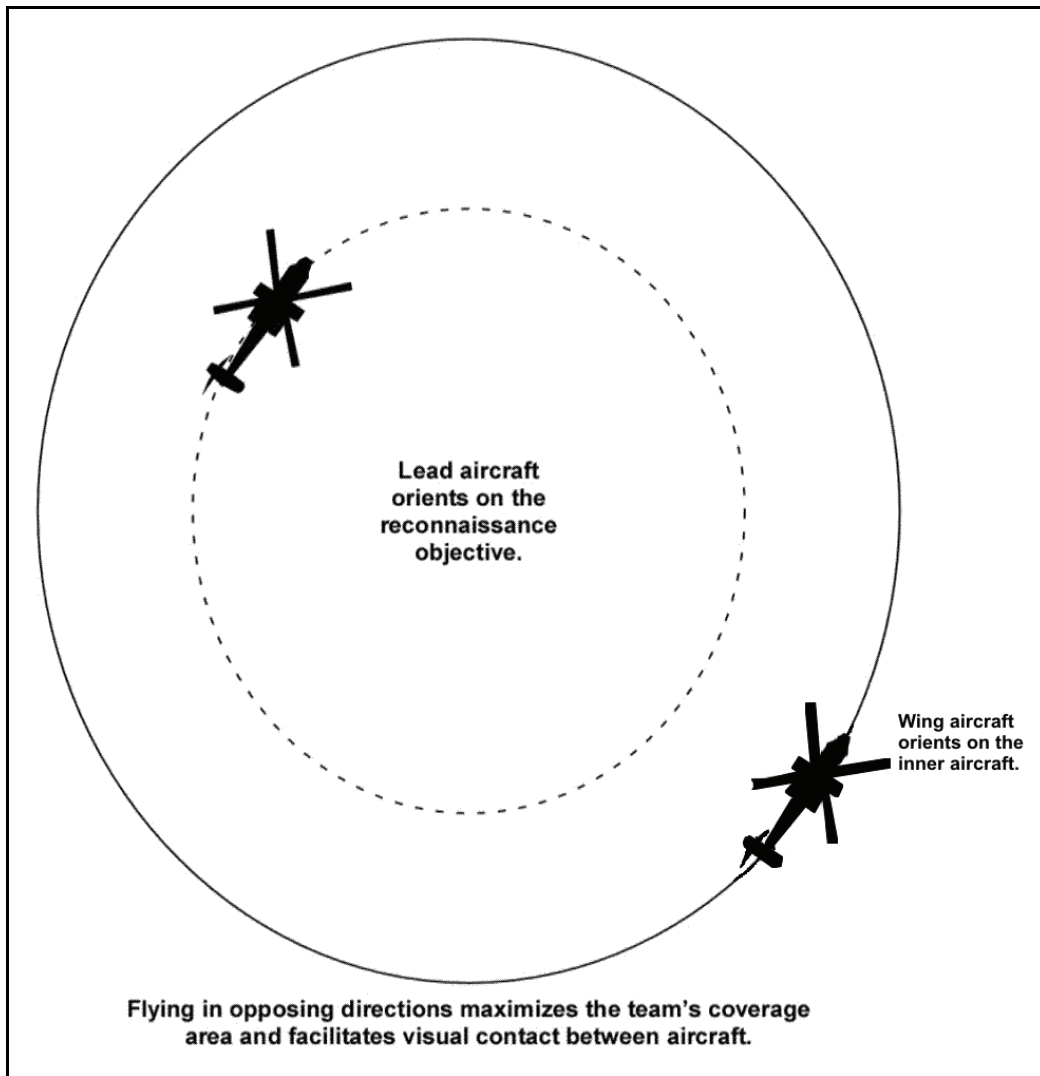

Figure 3-5. Inner/Outer Drill

Maintain Contact and Develop the Situation

3-88. **Team action.** The team in contact further identifies the threat. The team maneuvers to determine the threat's size, composition, orientation, and exact location of weapon systems. The team may also use the reconnaissance-by-fire method to determine the threat's tactical intentions. However, this method should be conducted with indirect-fire assets when possible to avoid revealing the aircrew's position. The team leader and/or commander needs to establish indirect and/or direct fire control measures to control fires. To determine if the threat can be supported by any other forces, the team should search for threat flanks and all adjacent terrain. The team identifies good counterattack routes into the flanks or rear of the threat. Once the team leader determines the extent of the situation, he forwards a follow-up SPOTREP.

Choose a Course of Action

3-89. **Team action.** Once the enemy situation has been developed, the team leader determines the best COA within the commander's intent, concept of the operation, and team's capabilities. Resuming the mission as soon as possible is normally the main criteria for COA selection. The possible COA may be—

- **Hasty attack.** The team leader can conduct a hasty attack if the target meets the engagement criteria for the mission, and the team possesses sufficient combat power to defeat the threat quickly. In most cases, the team does not have the capability to defeat a threat in prepared positions and is normally under specific instructions not to become decisively engaged.
- **Bypass.** If the team chooses to remain undetected and continue the reconnaissance mission, the team may maneuver to bypass the enemy. The team leader must receive the commander's permission (either verbally or as stated in the OPORD) to bypass any elements.
- **Hasty screen.** If the team cannot conduct a hasty attack and cannot bypass, it establishes a hasty screen and maintains contact through observation. The team concentrates on maintaining contact with the threat by fixing it in place with indirect, or possibly direct, fire until additional support comes from the company or other unit.
- **Support by another team.** The team in contact may conduct a BHO for a hasty attack by another team, if available.

Recommend or Execute a Course of Action

3-90. The commander, depending on the situation, must approve or disapprove the recommended COA based on its effect on the mission. The overriding considerations in selecting a COA are the intent of the higher commander and the unit's ability to complete the mission with minimum losses. The decision to conduct a hasty attack requires the commander and/or team leader to conduct hasty attack planning. This planning can consist of the following:

- Select an ABF or SBF position, if applicable.
- Define the EA.
- Define the target.
- Determine the method of engagement.
- Establish criteria for success.
- Establish a trigger point.
- Divide the EA for company and/or team level fire coordination establishing control measures for direct and/or indirect fire planning.
- Coordinate for CAS, JAAT, and artillery.
- Deconflict direct and indirect fires with ground units.
- Plan the BHO.
- Coordinate the change to sustainment requirements (for example, adjust weapons loads and adjust relief-on-station rotation).

3-91. This type of hasty planning should be incorporated into unit SOPs and battle drills.

CAPABILITIES

3-92. The ARB's tactical mobility, observation, and independent combined arms capability provides relevant and fresh information on the threat, terrain, and infrastructure as needed to conduct full spectrum operations. At the tactical level, combat information is often sufficient and more desirable than analyzed intelligence under time-sensitive close combat situations. The ARCs will always be responsive to the commander to shape the battle, answer CCIR, protect the main body, support TA and secure rear areas or LOCs, or fight for critical information. They can fight for information or perform reconnaissance missions. In addition, they facilitate their commander's battle rhythm and tempo, and provide combat information and support to close combat in real time.

3-93. The ARC's ability to conduct reconnaissance is a function of the enemy situation (especially enemy AD and direct fire systems), terrain in the AO, weather conditions, and the logistics support availability.

3-94. Without augmentation, a company has the capability to reconnoiter up to two routes continuously or three routes simultaneously for limited periods. It can conduct a zone reconnaissance, terrain dependent, of an 8 to 10 kilometer-wide zone at an average rate of 10 kilometers per hour. The rate depends on route complexity and desired detail.

RECONNAISSANCE METHODS

3-95. The three reconnaissance methods at the ARC level are aerial, reconnaissance-by-fire, and dismounted. The company commander and/or team leader may use any method or combination of methods to accomplish the reconnaissance mission under the considerations of METT-TC, and the higher commander's intent and guidance. Aerial reconnaissance may also include conducting coordinated reconnaissance forward of a ground element. When conducting reconnaissance forward of ground troops, coordination must take place to prevent fratricide. Refer to FM 17-95 for more information.

AERIAL RECONNAISSANCE

3-96. The ARC uses this method in most of its reconnaissance efforts. It is characterized by—

- The need for rapid reconnaissance.
- The use of aircraft systems to acquire targets or reconnaissance objectives at maximum standoff distance.
- Use of onboard video imagery to acquire the combat information.
- Low probability of enemy air defense artillery (ADA) threat.
- The integration of aerial reconnaissance assets and sensors with forward ground elements to accelerate reconnaissance tempo and movement.
- The requirement to maintain reconnaissance over extended distances.

3-97. The advantages of aerial reconnaissance are available firepower, maneuverability, advanced optics, navigational aids (NAVAIDs), and communication capabilities. The disadvantages are the larger overall signature and exposure of aircraft.

3-98. Aerial reconnaissance tasks include—

- Conduct as part of integrated air-ground (and eventually manned/unmanned) team to—
 - Avoid meeting engagement.
 - Develop the situation out of contact.
 - Identify HPTs.
 - Enable freedom of maneuver.
 - Enhance force protection.
- Orchestrate employing off-board and on-board R&S assets along with man-in-loop observation to see first and understand first.
- Apply fundamentals of reconnaissance.
- Execute actions on contact to fix, destroy, or disengage as required.

RECONNAISSANCE-BY-FIRE

3-99. Reconnaissance-by-fire is a method employed to find specific threat locations. When conducting reconnaissance-by-fire, the ARC places direct and/or indirect fire on suspected threat positions. The intent of reconnaissance-by-fire is to cause the threat to move or return fire, thus to disclose its exact location. This technique is appropriate when time is critical and stealthy maneuver to further develop the situation is not possible. The fires may be either direct, indirect, or a combination. The advantages of indirect fire are it does not give away friendly locations and usually causes the threat to displace from the impact area. An integrated J-SEAD plan around flight routes and BPs is a primary example of indirect reconnaissance-by-

fire. The disadvantages are it effects obscure observation and should not be used in close proximity to friendly units, structures of tactical or political importance, and noncombatants. Reconnaissance by fire may not cause a seasoned or prepared threat force to react. Reconnaissance by fire is always characterized as aggressive.

3-100. The commander may use reconnaissance by fire when—

- Situation meets liberal engagement criteria.
- Time is critical.
- A threat position is suspected.
 - Natural or manmade obstacles.
 - Obvious kill zone.
 - Signs of recent enemy activity.
 - Future friendly positions (BP/ABF/SBF/AA/HA) prior to occupation.
- Threat locations are known.

3-101. The reconnaissance by fire technique has other advantages and disadvantages. It is more advantageous with a poorly disciplined threat that will likely react when engaged. The disadvantages of reconnaissance-by-fire are the obvious loss of surprise, exposing the location of the firing element, and the possibility of becoming decisively engaged. When the ARC employs this technique, the available weapons are normally used in the following priority:

- Indirect fire.
- Machine gun and/or rockets.
- (Hellfire) missiles last.

In such circumstances, the ARC's limited organic firepower normally requires employing indirect fire as the primary means of engagement.

DISMOUNTED RECONNAISSANCE

3-102. Under extreme circumstances, the ARC commander may direct aircrews to conduct dismounted reconnaissance when information is required on a specific reconnaissance objective (close reconnaissance of obstacles, evaluation of bridges, and/or evaluation of ford or crossing sites). This method is time intensive, can place the aircraft in a vulnerable position, and does not make the best use of aircraft systems.

3-103. The commander may direct or expect aircrews to execute dismounted reconnaissance when—

- Time is available.
- Detailed information is required.
- Organic or supporting ISR sensors have already gained initial contact.
- Bypass criteria is restrictive.
- Low probability of enemy contact.

FORMS OF RECONNAISSANCE

3-104. The commander uses one of four forms of reconnaissance to further refine the scope of specified tasks and give the company mission spatial relationship. The four forms of reconnaissance are route, zone, area, and surveillance.

ROUTE RECONNAISSANCE

3-105. A route reconnaissance is conducted to obtain information about a specific route and all adjacent terrain from which the threat could influence movement along the route. The reconnaissance may be oriented on a road, axis, air route, specific LOC, railway, cross-country mobility corridor, or general direction of advance or attack. It provides new or updated information on route conditions such as obstacles and bridge classifications and threat and civilian activity along the route. The route reconnaissance may be performed as part of an area or zone reconnaissance.

3-106. The mission is best accomplished by the company employing attack reconnaissance teams with ground elements. Augmenting the attack reconnaissance team with UH-60s to transport infantry, ground scouts, or engineers can speed the reconnaissance effort. These elements gather information about the designated route and all adjacent terrain from which a threat could engage friendly forces with direct fires. The air teams begin the operation and reconnoiter to the front, flanks, and rear providing early warning, uncovering ambushes, and providing overwatch so the ground elements can concentrate on conducting a reconnaissance of the route. An air team element may periodically be required to dismount and physically inspect key terrain, if the situation allows. A route may be too long for the company to reconnoiter without rotating teams through a FARP. When the commander does so, at least one team is maintained in zone. The ground force, if available, commands the route reconnaissance.

Critical Tasks

3-107. The following are critical tasks for a route reconnaissance:

- Reconnoiter all terrain the threat can use to dominate movement along the route.
- Overwatch ground elements, especially in built-up areas.
- Access trafficability of the route.
- Locate sites for constructing hasty obstacles to impede threat movement.
- Reconnoiter all defiles along the route for possible ambush sites and locate a bypass.
- Locate a bypass around built-up areas, mines, obstacles, barriers, and contaminated areas.
- Locate suitable landing sites and zones and hazards to flight (suspected enemy AD locations, mountainous areas, wires, large bodies of water, open terrain, and other natural and manmade features).
- Find and report all threats that can influence movement along the route.
- Identify suspicious items along the route (IEDs, VBIEDs, or ambush sites).
- Identify existing or potential civilian use of route.
- Identify threat's ability to deny use of route through use of civilian interference.
- Identify and classify all bridges, overpasses, underpasses, and culverts that might restrict access.
- Locate fords and crossing sites in proximity to the route.
- Report route information, to include providing a sketch map or a route overlay.

Pre-mission Planning

3-108. Before conducting a route reconnaissance, the ARC must know certain information about the route. This information includes—

- Critical tasks to be accomplished by air reconnaissance teams and ground elements, when used. Any tasks that may be deleted during the reconnaissance are identified.
- Task organization. Any reinforcements, especially engineers, and their relationship to the company are identified. Supporting artillery relationships are also defined.
- Start point, RP, and designation of the route.
- Mission to be performed to the start point and after reaching the RP.
- Time the mission is to start and, if required, to be completed.
- Critical points along the route identified as checkpoints.
- IPB information on the route and threat situation.
- Any constraints or restrictions.
- Expected weather conditions for the time of movement.
- Type of unit or vehicles expected to use the route, if applicable.
- Time of day or night the route is expected to be used, if applicable.

Control Measures

3-109. Control measures for a route reconnaissance create an AO for the air reconnaissance teams conducting the reconnaissance. Typical company boundaries include—

- **Lateral boundaries.** Placed on both sides of the route, far enough out to allow reconnaissance of all terrain from which the threat could dominate the route.
- **Line of departure (LD).** Placed perpendicular to the route short of the start point. This allows adequate space for the teams conducting the reconnaissance to deploy into the chosen movement technique prior to the start point. The LD creates the rear boundary of the AO.
- **Limit of advance.** The LOA is placed far enough beyond the route's RP to include any terrain from which the threat could dominate the route. The LOA also provides greater depth and takes advantage of the aircraft's elevated observation platform and long range acquisition capability.
- **Coordination points or contact points.** Coordination points or contact points are included to enable proper flank coordination. The start point and a RP define that section of the route where the teams collect detailed information.
- **Phase lines (PLs) and checkpoints.** Added to maintain coordinated reconnaissance, control movement, or to designate critical points.
- **Additional fire distribution and FS coordinating measures.** Included to coordinate indirect and direct fire as necessary.

3-110. All of the above graphic control measures are placed along or on recognizable terrain features and, if possible, are identifiable from both the ground and air to assist in air-ground coordination. Figure 3-6, page 3-24, shows an example of a typical company's route reconnaissance graphics.

3-111. When time is not available, ground assets are not available, or the mission does not require detailed information, air reconnaissance teams may conduct a hasty route reconnaissance. In this case, information gathering is limited to the type of route (X—unlimited or all weather, Y—limited or fair weather, or Z—poor weather) and obstacle limitations (maximum weight, height, and width). The commander may also identify certain additional information to be gathered.

3-112. ARCs should keep records on all routes reconnoitered. Several methods are acceptable for recording this information. One method is to assign each key terrain feature (bridge, fording site, bypass site) a number on the map and detail the intelligence information on a separate work sheet. This method ensures completeness and simplicity and reduces map clutter.

3-113. The use of the video recorders to document areas of interest along the route provides superior combat information to the requesting headquarters. If the video/data recorder is used, planning must be conducted to return the video/data to the requesting headquarters, and crews must use a standardized video reconnaissance technique to clearly associate terrain with the targets portrayed on the video image. A plan must be developed to transmit images and data to the requesting headquarters.

Air Route Reconnaissance

3-114. The principles of an air route reconnaissance are the same as for a ground route, but the areas of interest are different. Aviation forces moving along an air route are primarily concerned with the location of enemy forces, ease of navigation, suitable landing sites and zones, and hazards to flight. Hazards to flight include suspected enemy AD locations, mountainous areas, wires, large bodies of water, open terrain, and other natural and manmade features.

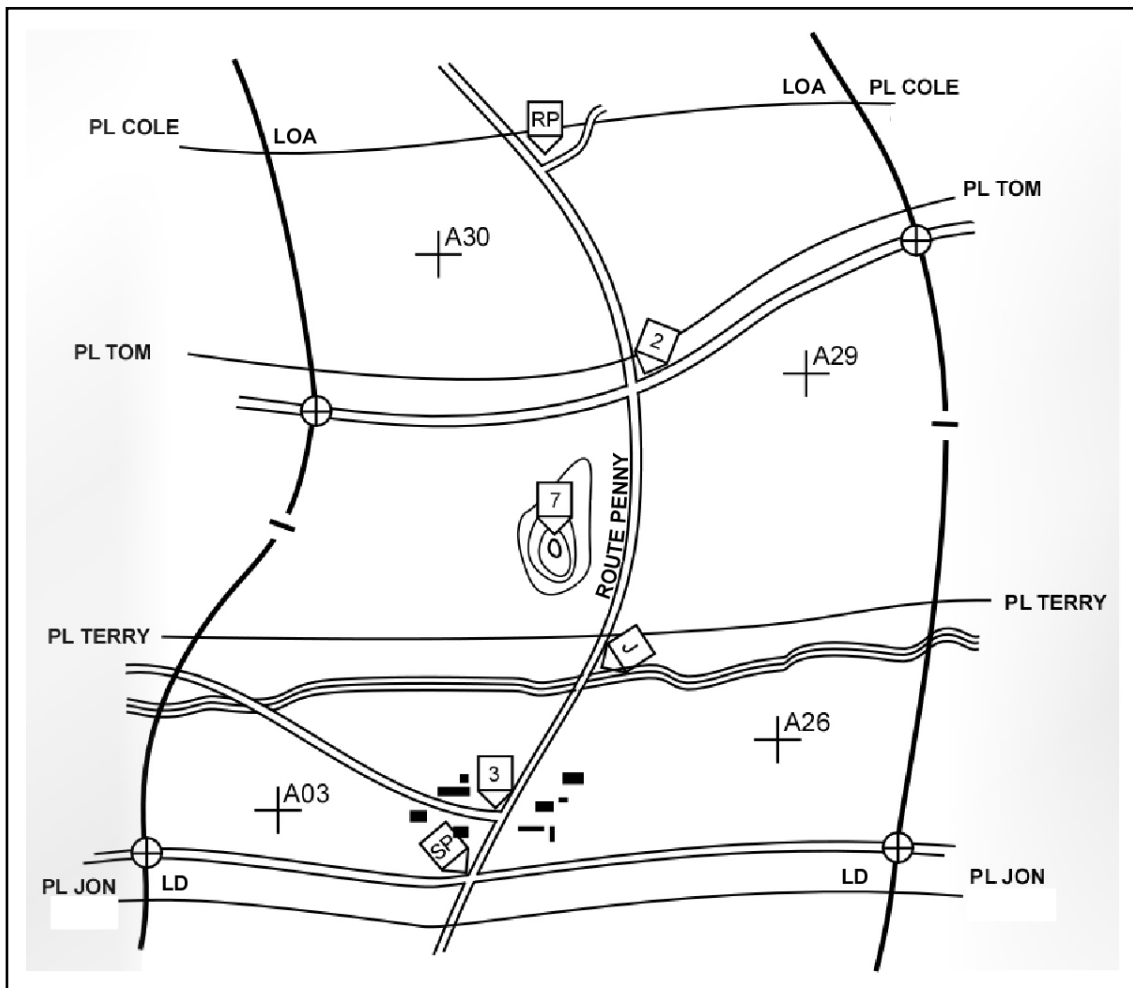

Figure 3-6. Example of company route reconnaissance graphics

ZONE RECONNAISSANCE

3-115. A zone reconnaissance is a directed effort to obtain information concerning all routes, obstacles (to include CBRN), terrain, and enemy forces within a zone defined by boundaries. The boundaries of a zone are restrictive, unlike those of an area reconnaissance, which are permissive. ARCs require permission from the ground commander to extend their reconnaissance outside of the zone's boundaries. It is the most time-consuming of the reconnaissance missions, so the company must allow for adequate time to plan and execute. A zone reconnaissance is frequently conducted over an extended distance, which dictates special considerations for team employment (example, FARP rotations). Figure 3-7, page 3-25, provides an example of company zone reconnaissance graphics.

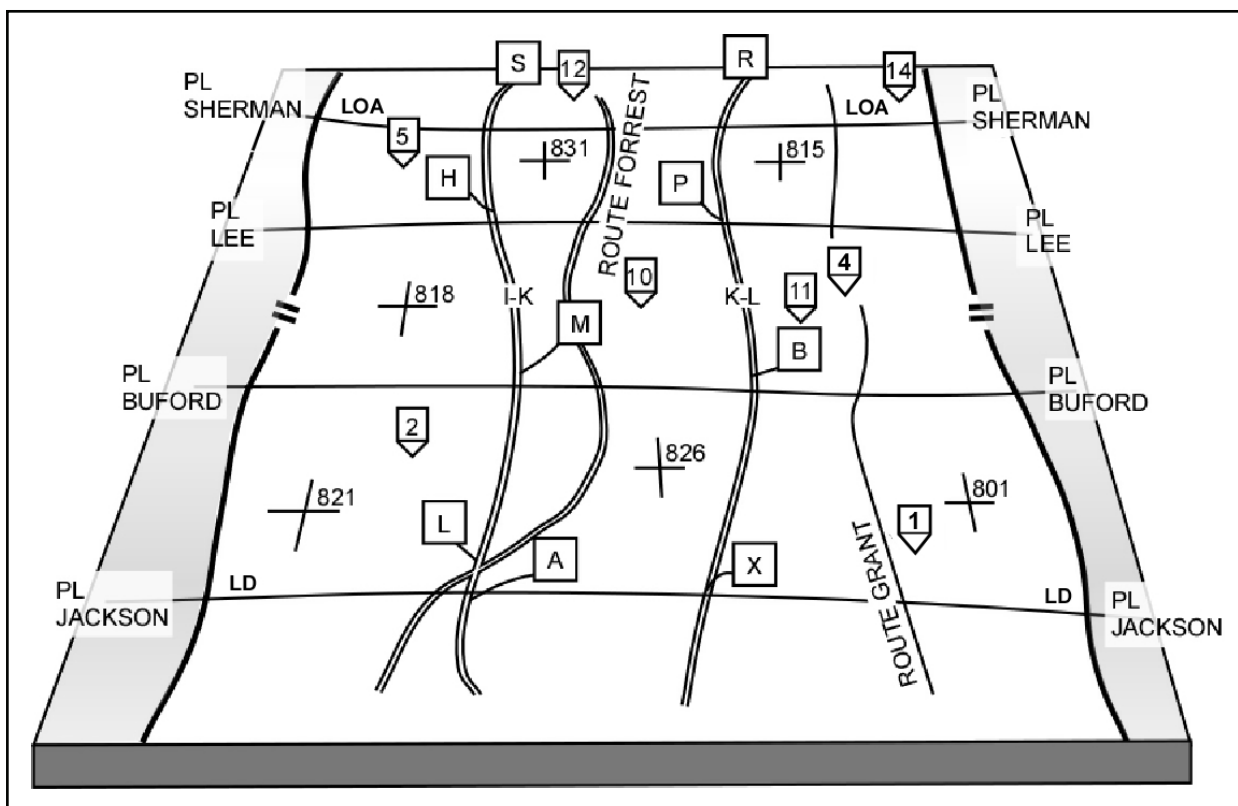

Figure 3-7. Example of company zone reconnaissance graphics

3-116. The purpose may be to find the enemy or suitable avenues of approach for the main body. A zone reconnaissance is normally conducted when existing knowledge of the terrain is limited, combat operations have altered the terrain, or when the enemy situation is vague. Obstacles encountered during a zone reconnaissance may include manmade obstacles (both existing and reinforcing), terrain obstacles, bridges and fords, and obstacles created by CBRN contamination. Every route within the zone must be reconnoitered unless otherwise directed. The zone to be reconnoitered is defined by lateral boundaries, a LD, and an objective or LOA.

3-117. Considerations for organizing a zone reconnaissance are the same as for organizing a route reconnaissance except that multiple teams operate abreast during the zone reconnaissance. The company may be tasked to conduct the zone reconnaissance alone or in conjunction with ground forces. Generally, when working with ground forces, the ARC performs a well coordinated zone reconnaissance forward of the ground forces and reconnoiters terrain not assessable to the ground elements. If time is critical, the ARC performs the reconnaissance alone with the understanding that the combat information obtained will be less detailed. If the company expects significant threat forces to be found within the zone, then the company must plan for dedicated FS assets and be prepared to conduct a BHO with ground forces.

Critical Tasks

3-118. The ARC conducting a zone reconnaissance performs the following tasks in accordance with its capabilities and limitations. If a company does not have the time or resources to complete all of these tasks, it must inform the commander assigning the mission. The higher commander will then issue further guidance concerning tasks the company must complete or the priority of tasks. The priority of tasks is usually consistent with the reconnaissance objective. If the company discovers during execution of the reconnaissance it cannot complete an assigned task, it must report and await further instructions.

3-119. Zone reconnaissance tasks are—

- Find and report all threat forces within the zone.
- Clear all threat forces in the designated AO within the company's capability.
- Find suitable covered and concealed ground or air avenues of approach.
- Reconnoiter terrain within the zone.
- Determine the trafficability of all terrain within the zone, including built-up areas.
- Locate and determine the extent of all contaminated areas in the zone, to include bypasses.
- Identify and classify all bridges, defiles, overpasses, underpasses, and culverts in the zone.
- Locate any fords, crossing sites, or bypasses for existing and reinforcing obstacles (including built-up areas) in the zone.
- Determine the presence of significant adverse weather.
- Overwatch ground elements during obstacle clearance operations.
- Report the above information to the commander directing the zone reconnaissance, to include providing a sketch map or overlay.

Permission Planning

3-120. Before departing on the mission, the team leader and aircrews select checkpoints and plan routes between checkpoints, using terrain and vegetation to conceal aircraft movement. The team leader also coordinates to ensure specific tasks for support of the ground force commander are integrated into the reconnaissance plan. Specific tasks assigned to attack reconnaissance teams working with ground forces include—

- Reconnoitering terrain not easily accessible to ground vehicles.
- Checking key points in zone (NAIs developed by higher and at company level).
- Locating and reporting the flanks of encountered enemy forces.
- Locating, reporting, and bypassing obstacles.
- Locating, reporting, and bypassing enemy positions.
- Providing security on the far side of obstacles while ground forces reconnoiter and clear them.

3-121. When a company conducts a zone reconnaissance in nonrestrictive terrain, it can operate up to 10 kilometers forward of ground forces due to the quality of communications, TA capability of onboard systems, and the aircraft's armament. Close coordination and continuous communication between forces is critical to reduce the risk of fratricide.

Control Measures

3-122. The company commander assigns boundaries between platoons/teams to specify sectors of responsibility. After establishing sectors, the company develops other control measures to include—

- Designating a LD and specifies a crossing time.
- Designating PLs as needed to control and coordinate forward movement. Failure to keep company elements abreast may result in the bypass of enemy elements, envelopment of supported ground forces by enemy forces, or engagement of friendly forces. Like boundaries, PLs should follow features easy to recognize, particularly for night operations or periods of limited visibility (smoke, haze, and fog).
- Establishing contact points, coordination points, and checkpoints to ease essential coordination between adjacent platoons. Contact points are designated on boundaries to ensure physical coordination between adjacent teams. Contact points are designated at—
 - Points that ensure proper coverage of the zone.
 - Critical points (such as a route crossing from one sector into another).
 - Points that ease movement, lateral coordination of fires or positions, passage of lines, or logistics support.

3-123. Platoons are assigned the responsibility of planning for the reconnaissance within the platoon sectors. Teams select the method of reconnaissance, mode of terrain flight, and movement technique based on the IPB with specific emphasis on hazards to navigation and threat ADA. Starting with the LD, the teams reconnoiter each sector in a systematic manner based on terrain, number of aircraft in the team, and the width of the sector. The teams reconnoiter from the LD to the objective or LOA.

3-124. Air reconnaissance teams report reaching PLs and continue in zone as directed. Once the operation begins, the enemy may be alerted to the movement of friendly forces. Forward momentum should be continued to gain and maintain enemy contact and to keep the enemy off balance.

AREA RECONNAISSANCE

3-125. The purpose of an area reconnaissance is to gather intelligence or conduct surveillance of a specified area. The area may be key terrain, a farm, bridge, ridgeline, wooded area, proposed AA, LZ, or other features that will be critical to an operation. The specified area to be reconnoitered is designated by boundary lines enclosing the area. METT-TC determines the movement technique the air reconnaissance team uses to reach the area and the method by which the area is systematically reconnoitered. The air reconnaissance team also reconnoiters dominant terrain outside the specified area from which the threat can influence friendly operations.

3-126. The company commander may divide the area into platoon zones with designated objectives for each platoon. The flanks of the overall objective area are secured first; reconnaissance efforts may then be focused inward. The air reconnaissance teams may establish a screen on the flank to provide security for the ground reconnaissance forces, if used. The air reconnaissance teams may have to dismount and physically reconnoiter a specific area.

Critical Tasks

3-127. During an area reconnaissance, the following critical tasks may apply:

- Reconnoiter specific terrain within the area and dominant terrain outside the specific area from which the threat can influence friendly operations.
- Find and report all threat within the area.
- Find suitable cover and concealed ground or air avenues of approach.
- Reconnoiter all terrain within the area and assist ground forces with built-up areas.
- Determine significant adverse weather.
- Locate a bypass around built-up areas, obstacles, and contaminated areas.
- Inspect and classify all bridges, overpasses, underpasses, and culverts within the area.
- Locate fords and crossing sites near all bridges in the area.
- Locate all mines, obstacles, and barriers in the area within its capability and overwatch ground units in their clearance.

Permission Planning

3-128. The commander first considers the factors of METT-TC. Rapid movement to the objective is important, but the main consideration usually is security. Avoidance of known threat locations and threat surveillance elements is imperative. Primary and alternate routes to the objective area are selected based on security and speed. Terrain flight techniques are used to move to the area. Upon completion of the reconnaissance, the air reconnaissance team departs the area on a different route.

Control Measures

3-129. The commander directing an area reconnaissance mission specifies the area for reconnaissance with a single continuous line to enclose the area to reconnoiter. Alternatively, he may designate the area by marking lateral boundaries, LD, and LOA. An area reconnaissance mission always specifies the route to take in moving to the area. The company conducting the area reconnaissance mission can use control

measures for a zone reconnaissance within the AO to control the operation of the air reconnaissance teams. Figure 3-8, page 3-28, is an example of company graphics for an area reconnaissance.

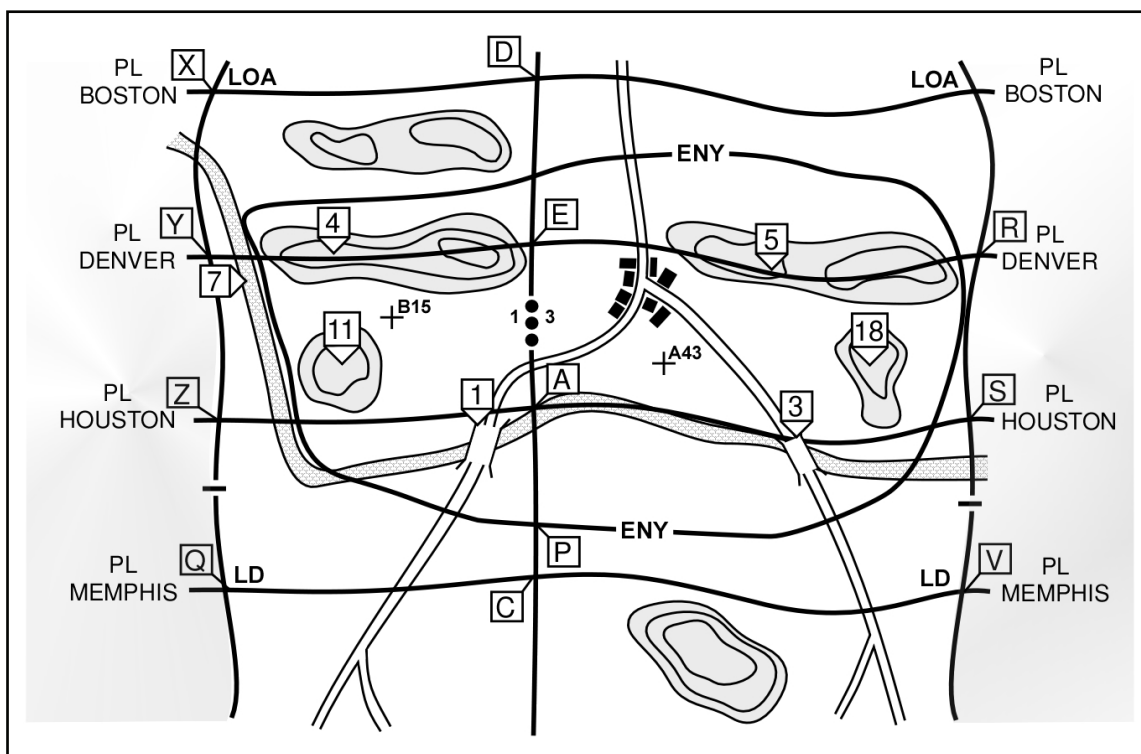

Figure 3-8. Example of company area reconnaissance graphics

3-130. The primary difference between a zone and an area reconnaissance is the nature (restrictive versus permissive) of the boundaries. A zone reconnaissance has restrictive boundaries that define the company’s mission area. Because of this, a zone reconnaissance does not have an implied task to reconnoiter dominating terrain outside of the zone. The boundaries of an area reconnaissance are permissive and allow the air reconnaissance team greater freedom in selecting their ingress and egress routes. The company may move to and reconnoiter one large area or several small, dispersed areas. An area reconnaissance may be performed behind friendly lines or deep behind enemy lines. Emphasis is normally placed on reaching the objective area quickly.

Landing Zone or Pickup Zone Reconnaissance

3-131. LZ/PZ reconnaissance is a type of area reconnaissance performed to determine the suitability for air assault operations. Principal concerns are determining if threat forces are present and can bring direct fires on the LZ/PZ and evaluating the physical characteristics of the area. LZ/PZ reconnaissance looks for predetermined, specific intelligence requirements. The company should receive, at a minimum, information on the ground force’s objective, planned actions after landing, the time of the air assault or air movement, and number and type aircraft in each lift. The air reconnaissance team evaluating the LZ/ PZ should conduct a survey and create a sketch of the area with pertinent information (figure 3-9, page 3-29). The air reconnaissance team should also include video and/or digital pictures, if possible.

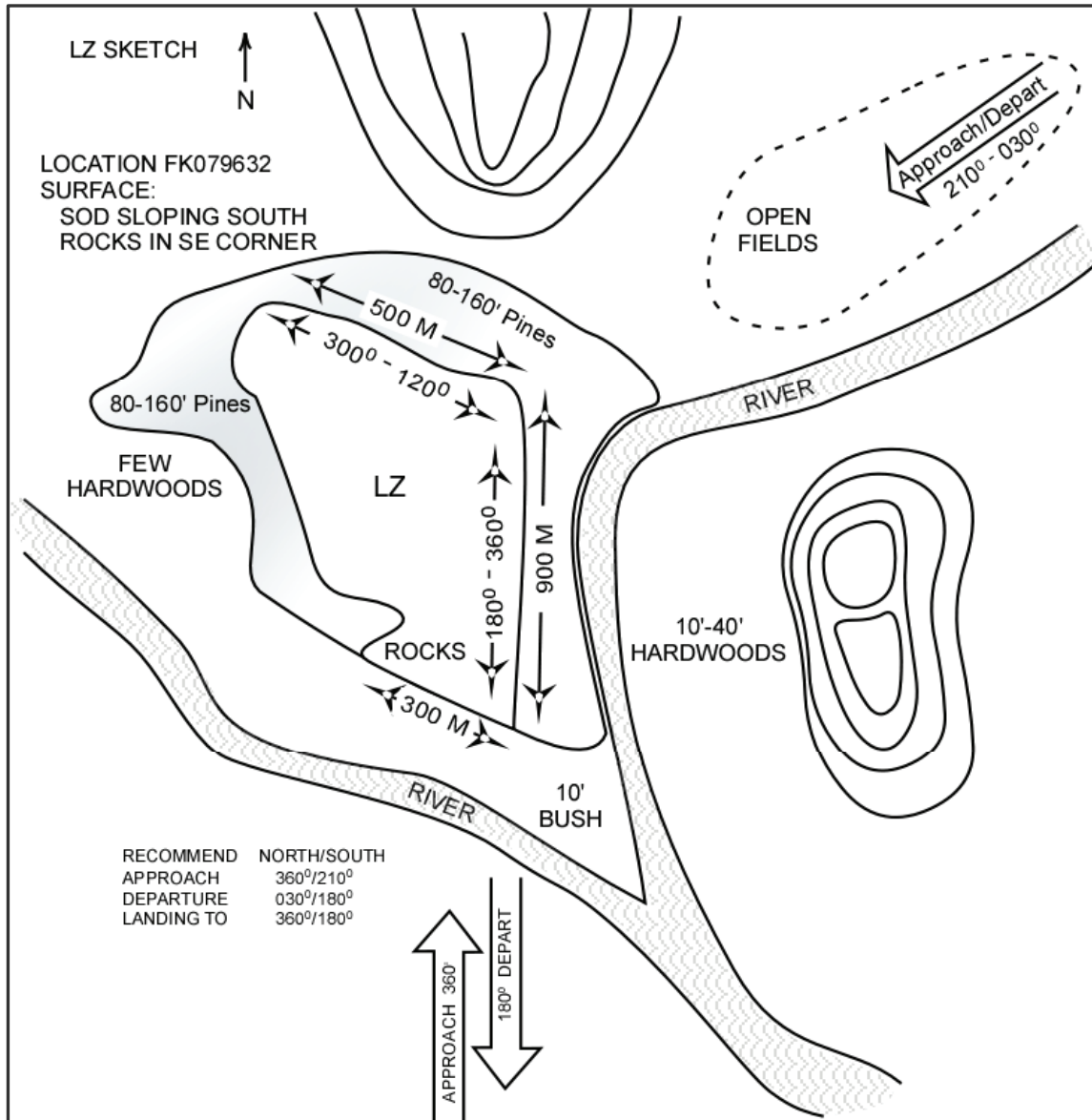

Figure 3-9. Example of landing zone or pickup zone sketch

Critical Tasks

3-132. Air reconnaissance teams evaluate and make recommendations of the following tactical considerations:

- **Mission.** Whether the LZ/PZ will facilitate the supported unit's ability to accomplish the mission.
- **Location.** Whether the LZ/PZ meets the commander's intent for distance from the objective.
- **Security.** The force required to provide security during the assault.

3-133. Technical characteristics of the LZ/PZ include—

- Landing formations.
- Obstacles and hazards in the landing area and vicinity.
- Number and type of aircraft the LZ/PZ can support.

- Ground slope of the landing area.
- Load suitability.
- Approach and departure directions.
- Size of the available landing area.
- Surface condition, including brown-out or white-out characteristics, of the landing area.
- Vulnerability.

3-134. If meteorological conditions observed during the reconnaissance are expected to be present during the air assault, reconnaissance elements assess the impact of—

- Ceiling and visibility.
- Density altitude.
- Winds.

Premission Planning

3-135. When conducting premission planning for a LZ/PZ reconnaissance, the company uses the same planning considerations as with the area reconnaissance—rapid movement to the objective is important, but the main consideration is security. Primary and alternate routes to the objective area are selected based on security and speed. Terrain flight techniques are used to move to the area. Upon completion of reconnaissance, reconnaissance elements depart the area on a different route.

3-136. Long range observation should be used whenever possible to reduce the threat's ability to determine the reconnaissance objective. If a flyover is required in a hostile environment, crews must be able to collect the desired information rapidly while flying over an area only once, if possible, but never from the same direction twice.

AERIAL SURVEILLANCE

3-137. Although primarily a mission for UAS, the ARC may be tasked with conducting surveillance. Aerial surveillance is defined as systematic observation to obtain detailed information of a specific target or area. The focus of surveillance is generally a point target such as a house, car, section of road, or any other defined area with specific threat indicators to trigger PIRs. ARCs use the same fundamentals to conduct surveillance as with any reconnaissance mission. When performed by the ARC, surveillance is normally overt in nature with the purpose of deterring enemy movement or activity.

SECTION IV – SECURITY OPERATIONS

3-138. Security includes all measures taken by a command to protect itself from surprise, provocation, espionage, sabotage, or observation by the threat. Security operations provide the protected force early and accurate warning of threat operations and develop the situation to provide time and maneuver space within which to effectively use the protected force to exploit or react to threat actions.

3-139. Security operations are characterized by reconnaissance to reduce terrain and threat unknowns, gaining and maintaining contact with the threat to ensure continuous information flow, and providing early and accurate reporting of information to the protected force. Security missions include screen, guard, cover, and area security missions. Security operations are defined by both the degree of protection offered to the main body and the physical characteristics of the operation. The battalion is capable of conducting and/or supporting all security missions; however, it normally participates in guard and covering force operations as part of a larger force.

3-140. The ARB commonly executes offensive tasks to provide security to its higher headquarters, and may conduct security operations to the front, flanks, rear, around, or between protected forces, sustainment or LOCs. The main difference between security and reconnaissance operations is security operations orient on the force, area, or facility being protected while reconnaissance orients on threat and/or terrain.

- 3-141. The fundamental purposes of the ARB in security operations are—
- Providing near real-time terrain and enemy information based on the commander's guidance and PIR.
 - Providing reaction time and maneuver space for the main body.
 - Preserving combat power.
 - Facilitating C2.
 - Facilitating movement.
 - Performing rear area operations.
 - Acting as a ready reaction force.
- 3-142. These roles are not necessarily missions themselves but are translated into mission statements by the battalion commander. Attack reconnaissance participates in these roles as a team with ground forces or as an independent force.
- 3-143. Security operations are conducted in all types of terrain, to include a complex variety of natural and manmade features and urban environments. Primarily considered shaping operations, ARC security operations can be an economy of force to control essentials such as key terrain over dispersed operations or provide more combat power for decisive operations. ARC security missions in support of urban operations include—
- Screening the flanks of forces—
 - Encircling to isolate an urban area.
 - Approaching to secure a foothold or conduct decisive operations within the urban area.
 - Participating in guard to develop the situation or secure a foothold in urban terrain.
 - Securing area of combat support or sustainment areas, critical infrastructure, facilities, or high-value assets.
 - Filling the gap between operations being conducted within or between urban areas or behind lead combat forces.
 - Protecting LOCs by securing routes and conducting convoy security to ensure uninterrupted supply of forward elements.
- 3-144. Considerations for security operations include—
- Orchestrating sensors to develop the situation.
 - Maneuvering to positions of advantage increasing agility and mobility of the force.
 - Developing and share the COP with all members of the air-ground team.
 - Applying principles of reconnaissance through gaining and maintaining contact.
 - Conducting actions on contact to fix, isolate, provide reinforcing fires, or destroy threat forces.
 - Synchronizing fires, maneuver, and tactical assault as required.
 - Maintaining communications with all members of the air-ground team.

FUNDAMENTALS

3-145. The ARB performs security missions to preserve the combat power and freedom of maneuver of friendly forces while providing information about the threat and terrain. ARCs provide security by providing information to and preventing threat observation and direct fires upon the protected force. Successful security operations are planned and executed by applying the following five fundamentals:

- Maintain threat contact.
- Orient on the force or facility to be secured.
- Provide early and accurate warning.
- Provide reaction time and maneuver space.
- Perform continuous reconnaissance.

MAINTAIN THREAT CONTACT

3-146. Once the ARC gains contact, it does not break contact unless directed to do so by its higher headquarters. This requires continuous visual contact, use of direct and indirect fires, freedom to maneuver, and depth in space and time. The key is to maintain mobility superiority over the threat forces. The ARC ensures a continuous flow of combat information and prevents the threat from endangering friendly forces.

ORIENT ON THE FORCE OR FACILITY TO BE SECURED

3-147. A security force operates between the main body and known or suspected threat units. The ARC commander maneuvers the company to positions to provide screening support to the main body commander's scheme of maneuver. The screen should be positioned to remain between the main body and the threat force. The distance is based on the relative vulnerability of the main body and expected threat rate of advance. As a general rule, the main body's required preparation time is multiplied by the expected threat rate of advance in kilometers per hour. This equals the minimum distance to emplace security. If this distance cannot be achieved, additional combat power and a more robust obstacle plan may be required.

3-148. The ARC operates at the prescribed distance and focuses all its actions on providing early warning and protecting the protected force, facility, or infrastructure. All aircrews must understand that the value of any terrain within their AO hinges on the advantages it provides in protecting the force or facility. The ARC orients on and, if necessary, moves with the protected force. The ARC commander and his subordinate elements must know the protected force's scheme of maneuver or defensive plan, and use their mobility and endurance differential to maintain security for the protected force or facility.

PROVIDE EARLY AND ACCURATE WARNING

3-149. Early warning of threat activity includes accurate reports regarding threat—

- Size.
- Current disposition.
- Composition.
- Location.
- Direction of movement.
- Rate of advance.
- Special equipment.

3-150. This gives the main body commander the time and information needed to seize or retain the tactical initiative and concentrate overwhelming combat power at the right time and place to engage the enemy.

PROVIDE REACTION TIME AND MANEUVER SPACE

3-151. Early and accurate warning, security purpose, and operating distances combine to provide the protected force time and space to effectively exploit or respond to threat actions. The higher commander specifies the ARC's security purpose and operating distance, or AO, enabling him to choose the time and place to concentrate against the threat from an advantageous position. Based on the security purpose, the ARC executes offensive or defensive tasks to fix, contain, delay, or disrupt threat tempo and cohesion, providing time and/or space to the protected force. At a minimum, the ARC operates at a distance from the protected force to prevent threat ground forces from observing or engaging the protected force or facility with direct fire. Operating distances will vary based on the operational environment, for example from 10 kilometers in rural terrain to a city block in urban operations.

3-152. The main body commander thinks and plans in terms of time and space required for maneuver and concentration of subordinate units against enemy weaknesses. Reconnoitering or performing security operations well forward or to the flanks of the main body, the ARC develops the situation and prevents the commander from fighting at a disadvantage. The ARC provides time for the commander to assess the situation, determine a COA, issue orders, and maneuver. The ARC also provides space to maneuver,

creating flexibility for the commander to respond to unanticipated threat initiatives. The amount of time and space provided may be determined by the higher commander's intent, but generally the mission defines it.

PERFORM CONTINUOUS RECONNAISSANCE

3-153. A security force performs continuous reconnaissance to gain all possible information about the enemy force and terrain within the assigned AO. Accurate, timely information provides security; the ultimate goal is to answer the commander's PIRs and enable timely decisions by the protected force commander to influence the operation.

PLANNING CONSIDERATIONS

3-154. The ARC must receive additional critical information beyond just the security mission. The following critical items of information are needed to facilitate planning:

- Dimensions of the security mission (normally depicted on graphic overlay).
- Minimum reaction time required. This allows the ARC commander to determine if the depth of the security zone is sufficient to accomplish the mission and determines how long the security force must delay before falling back to successive PLs.
- Minimum sized threat force that must be detected. This allows the ARC to determine required density of the screen.

3-155. The ARC follows general planning principles in preparing for a security mission and determines the number of teams required to perform the mission. The company specifies the area of the security and time the security must be effectively established with battalion-size avenues of approach into the identified area. The depth of the area should provide enough distance for the main body to react in minimal time. The company must not establish its initial security too close to the main body, but within range of the main body artillery. The initial screen also follows advantageous terrain for observation of avenues of approach. It is delineated by a PL and located behind critical control measures such as CFLs and fire support coordination lines (FSCLs). PPs and routes through stationary units are also coordinated.

3-156. Consideration must be given when assigning the ARC its own terrain. ASE and/or EW considerations must be part of the mission planning process to minimize risks while accomplishing the mission. Limited visibility conditions and weather may affect the ARC's ability to cover a zone and/or sector. Conversely, there are times when ground units are limited by mobility, terrain, vegetation, or time, and the ARC is the only asset capable of conducting the mission.

3-157. The company commander, in conjunction with the protected force commander, must determine the width and depth of the security and establish a rear boundary between the main body and security force. The company may initially assume responsibility for the area between the main body and security force. The company may conduct a zone reconnaissance from the main body to the initial screen line and then maintain surveillance between the security force and screen line. The main body may be required to conduct patrols or establish OPs near their positions. The ARC must carefully plan and coordinate its subsequent rearward movement and passage of lines.

3-158. Fires are planned, and emplacement of manmade obstacles is coordinated to impede the threat's advance. The combination of fires and natural and man-made obstacles allows the company to impede threat lead elements, maintain contact, and avoid decisive engagement. The company may also continue reconnaissance forward to identify threat second echelon and follow-on forces. Upon contact, the company focuses its effort on the destruction of threat reconnaissance elements by direct and indirect fires before the threat can penetrate the initial screen line.

CAPABILITIES

3-159. Commanders consider METT-TC when employing their company in a security role. A screen or area security may normally be assigned to the company; fill the gap, LOC security, and guard may be assigned to the company but requires augmentation. However, depending on METT-TC, the company may

not be fully capable to conduct the associated tactical tasks within the operational environment without augmentation.

3-160. ARCs execute security operations as independent operations or in a supporting role to the ground maneuver commander. The higher commander's intent and purpose for security, combined with the mission's duration within the operational environment, determines the required augmentation. Requirements to conduct sustained operations, defeat or destroy threat forces, or accept decisive engagement may require task organization to include mechanized or light infantry, tank, DS or reinforcing artillery, intelligence systems, UAS, EW assets, and communication nodes. Urban operations and other stability operations may require military police, PSYOPS, and CA augmentation.

3-161. An ARC, operating independently, normally maintains an 8 to 10 kilometers front based on METT-TC. Using its organic firepower, it screens or fights within range of the main body artillery. This maximizes its ability to provide reaction time and maneuver space for the main body commander to concentrate combat power. During cover operations, forces forward may be out of the main body's artillery range.

TYPES OF SECURITY OPERATIONS

3-162. The four types of security missions the ARC is expected to conduct and participate in are screen, guard, cover, and area security.

SCREEN

3-163. The primary purpose of a screen is to provide early warning to the main body through the communication of real-time combat information. This gives the protected force reaction time and maneuver space to orient to meet the threat. The screen provides the protected force with the least protection of any security mission. The ARC screens forward and to the flanks or rear of a stationary main body and to the flanks or rear of a moving main body. Screening operations are not performed forward of a moving force because that would be an advance guard or zone reconnaissance. Based on the higher commander's intent, the ARC may be required to impede and harass the enemy with supporting fires and, within its capabilities, destroy or repel enemy reconnaissance elements without becoming decisively engaged. Otherwise, the ARC fights only in self-defense. See figure 3-10 for screen locations.

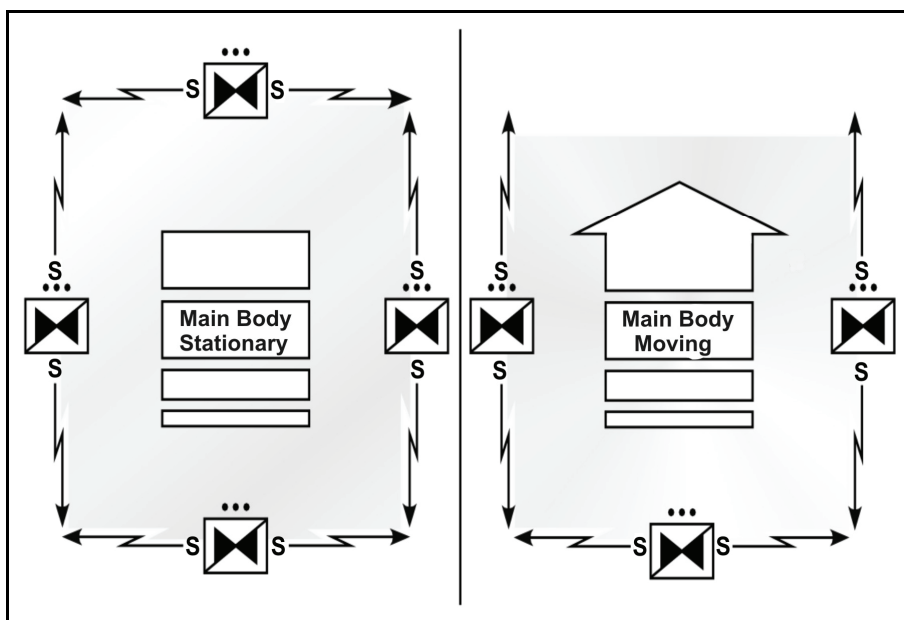

Figure 3-10. Screen locations

3-164. Screen missions are defensive in nature, largely accomplished by establishing a series of OPs to ensure adequate surveillance of the assigned sector. Although defensive in nature, a screen is active in execution. Stationary screens may be conducted around or between any force, while moving screens are conducted everywhere except in advance of a moving force. The higher commander should not place a time duration for the screen, as that may force the ARC to accept decisive engagement.

3-165. A screen is most appropriate when—

- Operations have created extended flanks.
- Gaps exist between ground commands that cannot be secured in force.
- Early warning is required over an area not considered critical enough for greater security (economy of force).

Critical Tasks

3-166. The following are critical tasks for conducting screen operations:

- Provide early warning of threat approach.
- Maintain contact with the protected force.
- Maintain continuous surveillance of all avenues of approach larger than a designated size into the sector.
- Maintain contact with threat forces, not allowing threat ground elements to pass through the sector undetected and unreported.
- Destroy, repel, or suppress threat reconnaissance and impede or disrupt threat forces (within capabilities) in accordance with guidance without becoming decisively engaged.
- Impede and harass the enemy with indirect fires while displacing.
- Guide reaction forces.
- Locate threat security forces and the main body to determine their direction of movement, composition, and intent, if applicable.

Permission Planning

3-167. The ARC commander plans his concept using the following critical considerations:

- **Aircraft rotation.** The commander determines the method of rotating aircraft to sustain an aerial screen. The ARC commander must consider all aspects of the mission—time required for the mission, aircraft availability, and expected relief on station.
- **Organization.** The commander organizes the screen based on higher commander's guidance, likelihood of threat contact, size of assigned sector, duration of the mission, and aircraft availability. If large frontages or several avenues of approach need to be covered, the company may deploy in teams instead of platoons.
- **Coordination.** The ARC ensures the location of FARPs, supporting fires, and forward assembly areas (FAAs) are known by all aircrews. The commander coordinates his concept closely with the higher commander. The ARC must pay particular attention to OP locations, artillery positions, and the ground scheme of maneuver. Coordinating the air passage of lines when operating forward of ground units is essential.
- **Concealment.** The company situates the screen to maximize the ARC's ability to maintain concealment while observing the operational environment. Teams work together, ensuring fields of observation overlap and preventing the threat from passing undetected. Air routes to and from succeeding screen lines should provide adequate cover and concealment. Cover may be difficult to obtain along a route, but concealment is critical. During movement, teams ensure visual contact with the threat is continuously maintained.
- **OP emplacement.** The most forward OP is positioned abeam the leading ground unit, while the subsequent OPs are arrayed in depth along the length of the main body toward the rear. OP selection should be based on fields of observation into NAIs. Movement along the flank screen line may be controlled using one of three methods—successive bounds (similar to bounding

overwatch), alternate bounds (similar to traveling overwatch), or continuous (similar to traveling). The most secure technique is one in which aircrews move from the trail OP to the most forward OP. This works best when the main body is moving slowly. A less secure technique may be used when the main body is moving faster. It involves all OPs moving forward simultaneously on command to the next OP. The screening force may also move continuously, but this is the least secure and least preferred method. Table 3-3 provides a list of movement methods.

- **Enemy aircraft.** Part of the screen mission may be to alert friendly forces of approaching enemy aircraft. The teams maintain surveillance of air avenues of approach the same way they maintain surveillance of ground avenues of approach. Reports of incoming aircraft alert all assets in the area to take appropriate action. Linking the company to the AD warning system provides aircrews the SA needed to maintain an effective aerial screen.
- **Displacement.** The ARC must identify the criteria for displacing to a subsequent screen line. As the threat situation threatens the security of the screening force, the company reports and requests movement to the next screen line. Staggered movement of the screen line allows the company to identify the flanks and rear of attacking threat forces. The ARC commander usually decides when to move from a screen line; however, the higher commander decides when the company may move behind the rear boundary PL. Prompt, accurate reporting is essential to prevent decisive engagement. Maximum use is made of onboard aircraft sensors.
- **Command and control.** The ARC commander chooses the best position to control the screen line. Normally, this is at a vantage point from which he can move freely, maintain communications with both higher and subordinate elements, and best influence the operation.

Table 3-3. Flank security movement methods

Method	Characteristics	Advantages	Disadvantages
Successive Bounds	<ul style="list-style-type: none"> • Main body is moving slowly. • Conducted by platoon or company. • Contact is possible. • Conducted simultaneously or in succession. 	<ul style="list-style-type: none"> • Most secure method. • Maintains maximum surveillance. • Maintains unit integrity. 	<ul style="list-style-type: none"> • Execution takes the most time. • Unit is less secure when all elements are moving simultaneously. • Simultaneous movement may leave temporary gaps.
Alternate Bounds	<ul style="list-style-type: none"> • Main body moves faster. • Conducted by platoon or company. • Contact is possible. • Conducted from rear to front. 	<ul style="list-style-type: none"> • Maintains good surveillance over the security area. • Secure, but faster than successive. 	<ul style="list-style-type: none"> • Execution takes time. • Disrupts unit integrity. • May leave temporary gaps in coverage.
Continuous	<ul style="list-style-type: none"> • Main body is moving relatively quickly. • Performed as a route reconnaissance. • Threat contact is not likely. 	<ul style="list-style-type: none"> • OPs displace quickly. • Maintains unit integrity. 	<ul style="list-style-type: none"> • Least secure method.

TYPES OF SCREENS

3-168. The ARC conducts two types of screen missions—stationary and moving.

Stationary Screen

3-169. The ARC conducts a screen for a stationary force when the main body commander is preparing for future TACOPs. During reconstitution activities or planning and preparation phases, the main body commander may remain stationary. The ARC may be assigned screen operations when ground forces are preparing for defensive or offensive operations before actual movement begins. Initial occupation of a unit BP may also require screening activities. Figure 3-11 illustrates a company stationary screen.

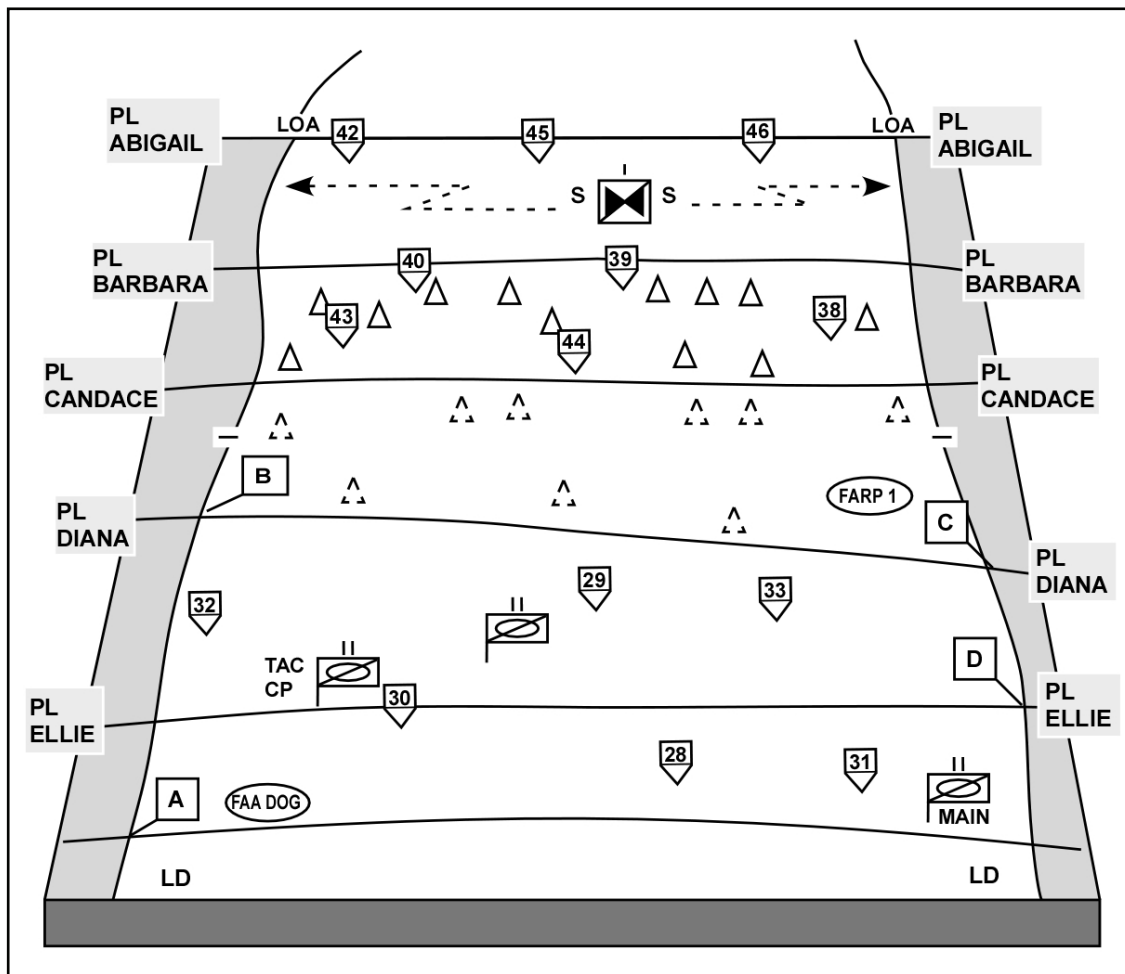

Figure 3-11. Stationary screen

3-170. The ARC commander occupies the assigned sector and establishes OPs with overlapping fields of observation, and in depth when at all possible. Teams are positioned to take advantage of established links with higher echelon collection assets and sensors. Ground forces reconnoiter areas that cannot be observed by OPs, and the TF reserve is positioned to react in accordance with its planning priorities and for flexible response to unforeseen contingencies.

3-171. The ARC uses fires to destroy threat reconnaissance and HPTs, and disrupts movement of other forces based on its TA requirements and ROE. OPs engage at maximum ranges with indirect fire only, directing ground units to engage with direct fire if available. The company commander determines when to move to subsequent screen lines; however, during linear operations the protected force commander decides

when the ARC can move behind the screen line (PL) designating its rear boundary. Displacement to subsequent screen line or OP positions is normally event driven, but the company commander may direct a displacement if the company's security is threatened even if the criteria has not been met. Teams displace using alternate or successive movement, but must maintain contact with threat forces unless it conducts a BHO with another unit.

3-172. If the ARC requires relief on station or BHO from another unit, the battalion/TF staff coordinates with the relieving unit to determine the requirements. Reconnaissance elements relieve each other by aircraft, team, or company as briefed. In each case, the ARC flight lead links up with the incoming leader and communicates the current friendly positions, enemy situation, and plan for relief or handover. When the AMPS is used to maintain a SA net, the relieving force should arrive with updated graphics, reducing the time needed to conduct the relief or handover.

Initial screen line

3-173. The most secure method of establishing an initial screen line is conducting a force oriented zone reconnaissance to the initial screen line. When the teams reach the general trace of the screen line, they reconnoiter and refine it. Positions are also selected for good observation and fields of fire. The teams seek to remain undetected while reporting threat activity and engaging threat forces with indirect fires at maximum range. A combination of obstacles and coordinated fires allows teams to impede threat lead elements, maintain contact, and avoid decisive engagement. This gives the main body reaction time and maneuver space to engage the threat effectively. The company may continue reconnaissance forward to identify threat second echelon and follow-on forces. Upon contact, the teams focus efforts on the destruction of threat reconnaissance elements by direct and indirect fires before the threat can penetrate the initial screen line.

Successive screen line

3-174. Successive screen lines, located one behind the other, provide the ARC with maneuver space. As threat pressure compromises the security of the ARC, or the movement of the main body dictates, the company reports and requests to move to the next screen line. Teams rapidly move from a screen line while maintaining visual contact with the threat. Staggered movement off the screen line ensures that gaps occurring during movement are quickly closed. The procedure is repeated as necessary. The main body commander decides when the ARC is no longer necessary as a screen force and allows it to conduct follow-on missions. Maximum use is made of the aircraft's onboard sensors.

MOVING SCREEN

3-175. When the main body is moving, the ARC conducts a moving screen and determines the technique of screening based on METT-TC, the maneuver force commander's intent, and the company's orientation. The commander assigning the screening mission provides the parameters of the screen and times and locations of the establishment of the screen. The higher commander also identifies the unit or units to be screened and provides the operations overlay and control measures.

3-176. The emphasis of a moving screen may vary from a stationary screen, as it is not normally performed to the front of a moving force but to the flanks or rear of the protected force. A moving rear screen is executed similar to a front stationary screen. As the protected force moves, the company occupies a series of successive screen lines behind the protected force. Movement is regulated to maintain the protected force's commander's desired time and distance factors. For a moving screen, the width of the AO is not as important as the length of the protected force.

3-177. The three types of moving screens are flank, rear, and rear area incursion.

Moving flank screen

3-178. The moving flank screen is the most difficult screening mission. ARC elements move on a route parallel to the movement axis of the main body. The higher commander defines the initial area to be

screened, subsequent screen lines, and the rear boundary. ARC teams occupy a series of OPs on the screen line. The forward team(s) maintains contact on the near flank of the main body as the lead elements move on the axis of advance. The main body and ARC must maintain contact at all times. When working with ground units in a moving flank screen mission, ARCs are well-suited to maintain contact with the main body and perform reconnaissance forward of the ground units. An ARC screening to the flank of a moving unit plans a line of OPs and prepares to occupy each, in turn, as the main body advances. If possible, the ARC reconnoiters out to the maximum range of supporting fires. Except for these procedures, the mission is planned and conducted the same as a stationary screen. While maintaining contact with the main body, the teams must be aware of the distance of the ground units from the main body to prevent over-extension of the screen. Figure 3-12 provides an example of a company conducting a moving flank screen.

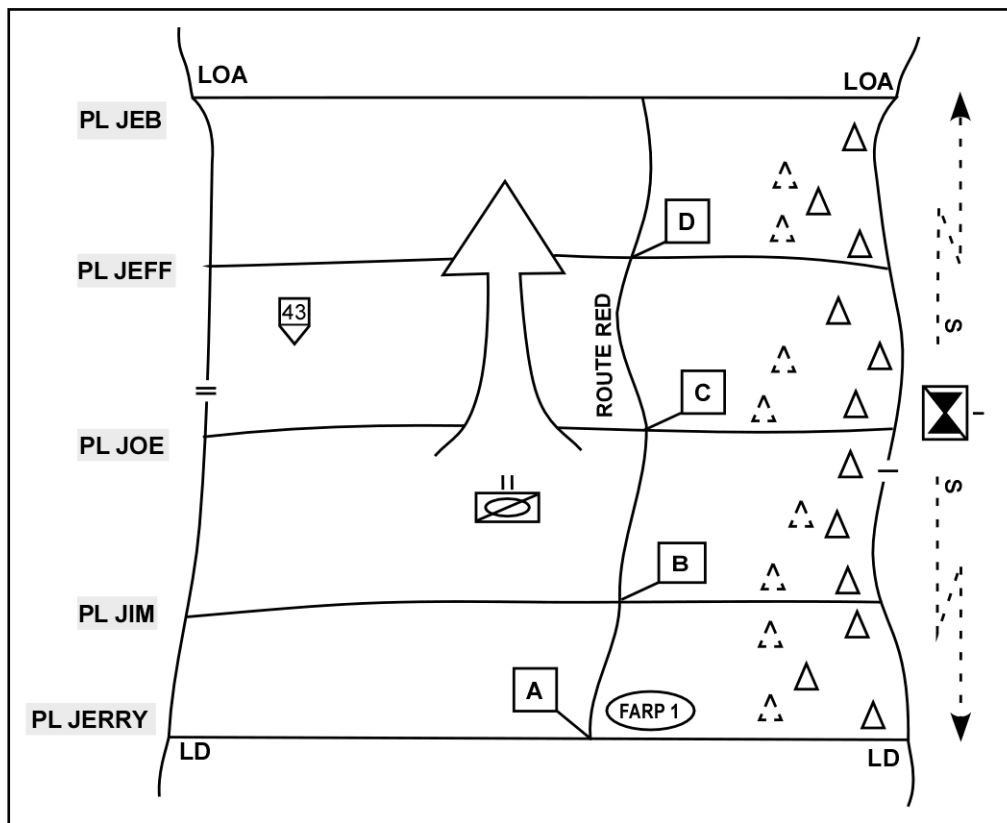

Figure 3-12. Moving flank screen

Moving rear screen

3-179. Screening the rear of a moving force is essentially the same as screening a stationary force. As the protected force moves, the ARC occupies a series of successive screen lines. Movement is regulated by the requirement to maintain the time and distance factors desired by the main body commander. Sectors and responsibilities are assigned as in the stationary screen. In a rear screen, a company may move to subsequent screen lines without threat pressure as long as it remains within friendly artillery range and can effectively screen the rear. If threat contact is made, the teams execute actions on contact the same as a stationary screen. Figure 3-13, page 3-40, provides an example of a company conducting a moving rear screen.

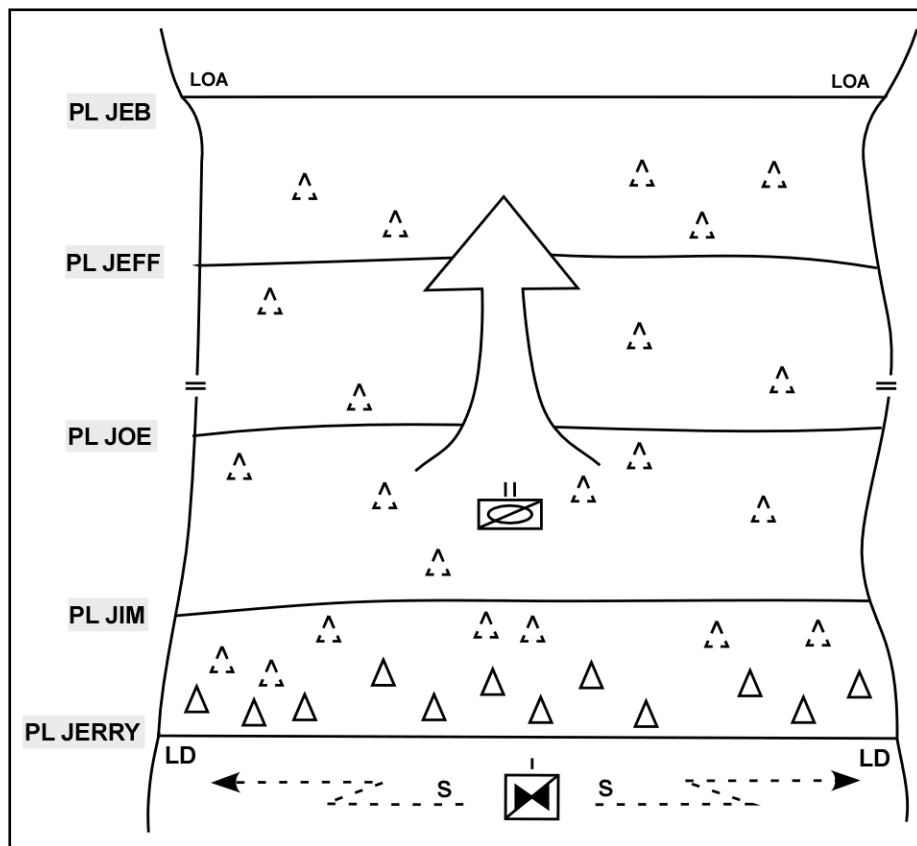

Figure 3-13. Moving rear screen

Rear area incursion screen

3-180. During rear area enemy incursions, the ARC responds and conducts both attack and security operations. The purpose is to gain and maintain contact, and destroy threat forces in conjunction with ground reaction forces. Aircrews guide friendly QRFs or assist in the attack and destruction of the threat force. Figure 3-14, page 3-41, shows the ARC's role in a rear area incursion operation.

GUARD

3-181. A guard force accomplishes all the tasks of a screening force. A guard operation protects the main body from enemy ground observation, direct fire, and surprise attack. A guard may be performed for a stationary or moving force, and to the front, flank, or rear of the main body. The guard force reconnoiters attacks, defends, and delays as necessary to destroy enemy reconnaissance elements and disrupt the deployment of enemy first echelon forces. The guard force normally operates within the range of main body indirect-fire weapons. The main body commander assigns the guard mission when contact is expected or there is an exposed flank that requires greater protection than a screen provides.

3-182. The ARC cannot perform a guard mission independently and without augmentation of ground forces. Normally, the ARC performs zone reconnaissance, screen operations, hasty attacks, and CCA in support of the BCT or ground maneuver TF conducting the guard operation.

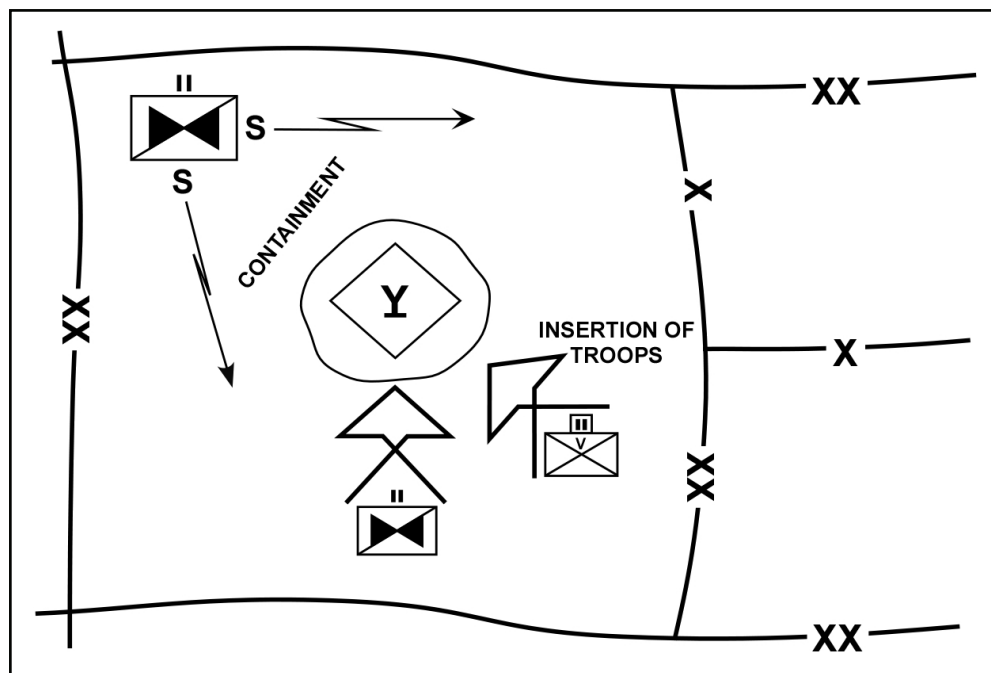

Figure 3-14. Rear area incursion screen

Critical Tasks

3-183. When operating as an element of a guard force, the ARC conducts the following critical tasks for the ground maneuver commander:

- Performs reconnaissance along the main body's axis of advance.
- Performs reconnaissance between the main body and guard force BPs.
- Maintains continuous surveillance of threat avenues of approach larger than a designated size into the AO.
- Maintains contact with threat forces, not allowing threat ground elements to pass through the AO undetected and unreported.
- Maintains contact with the lead combat element of the main body.
- Destroys or repels threat reconnaissance and security forces and impedes or disrupts threat forces in accordance with guidance and capabilities.
- Defeats, repels, or fixes threat ground forces before it engages the main body with direct fire.
- Locates and causes the threat main body to deploy, determining its composition and direction of travel, if applicable.

Permission Planning

3-184. The commander assigning the guard mission must indicate the type and level of protection required, and the time the guard is to be established. Expected duration of the guard mission should also be given. Because guard forces are expected to force and disrupt enemy deployment, the ARC operates on a narrower front than when conducting a screen. A commander directing a guard mission must consider the requirement to clear the area between the main body and the unit's guard-designated positions. The ARC may need additional assets to clear the area while keeping adequate combat power forward to protect the main body. The ARC may have FA in DS or priority of fires. This assistance depends on artillery support available and type and level of protection required by the commander who assigns the guard mission. Normally, guard units occupy BPs across the most likely avenues of approach. The units do not withdraw

to successive positions without the permission of the main body commander. Elements within the guard force often have different missions.

Example: The ARC may screen a less vulnerable zone while the remaining ground elements guard an area with critical avenues of approach. The ARC commander utilizes the same planning factors for a screen to support the guard operation. The ARC may also be designated as the TF reserve or QRF and positioned to support the ground guard force with hasty attacks and CCA.

TYPES OF GUARD OPERATIONS

3-185. The ARC supports two types of guard missions—stationary and moving.

Stationary Guard

3-186. A stationary guard is performed when the main body is not moving. It may be conducted to the front (advance), rear, or flanks of the main body but is normally conducted to the front. As part of a stationary guard, the ARC deploys forward of a designated PL, usually within friendly artillery range, and conducts reconnaissance and screening operations. The main guard force does not displace behind the designated PL without the permission of the main body commander. A PL designating the rear of the ARC's area is farther from the main body than the effective range of threat direct fire weapons. The ARC conducts a zone reconnaissance from the rear to the BPs or OPs, reconnoiters the BPs or OPs, and establishes a screen line. It provides reaction time for the main guard force and, consequently, the main body. The ARC determines the threat's disposition, destroys threat reconnaissance elements, and assists the main guard unit in forcing the threat to deploy. It also disrupts the threat's forced deployment and guides main body reaction forces for the counterattack.

Advance guard

3-187. An advance guard for a stationary force deploys forward and defends. Once contact is made, the ARC continues to defend in sector or delay consistent with the commander's intent. An advance guard for a moving force is offensive in nature, finding and defeating threat units along the axis of advance. The ARC usually participates as part of an advance guard providing uninterrupted movement of the protected force and prevents surprise and premature deployment of the main body. If the ARC encounters threat forces beyond its capability, it defends, continues close reconnaissance and prepares to pass elements of the main body forward.

3-188. As units of the advance guard identify targets of opportunity, the ARC can expect to conduct hasty attacks to destroy or disrupt those targets. The rapid mobility of the ARC allows the advanced guard commander to quickly attack, destroy, and move through located threat forces; bypass threat forces to look deeper; or to quickly develop the situation and await the arrival of the main body. The advance guard commander may task the ARC to reconnoiter forward of ground units or screen along exposed flanks.

3-189. When tasked with this mission, the ARC conducts the following tasks in addition to the critical tasks associated with a screen:

- Determines the trafficability of high-speed routes within the zone.
- Inspects and classifies bridges, culverts, overpasses, and underpasses along high-speed routes.
- Identifies all bypasses and fords able to support rapid movement of heavy equipment.
- Identifies obstacles, choke points, and likely ambush areas and determines possible bypass routes.
- Finds and reports all enemy forces within the zone and determines size, composition, and activity.

Flank guard

3-190. Flank guards are reconnaissance oriented, concentrating on threat battalion-sized avenues of approach to protect an exposed flank of the main body. In performing this mission, the ARC operates beyond the assigned zone or sector of the protected force. Normally, the ARC's responsibility begins at the trail element of the advance guard or the lead combat element in the main body, and ends at the rear of the protected force or lead element of the rear guard. The protected force commander clarifies this responsibility as necessary. A flank guard is similar to a flank screen except that defensive positions are planned for in addition to OPs.

3-191. ARCs can be integrated as part of the guard force by screening between and in front of BPs as they are established. The ARC may also be used to reconnoiter the area between the guard force and main body, maintaining contact with both elements and freeing the ground flank guard force to concentrate on its BP tasks. Figure 3-15 shows a company conducting a stationary flank guard.

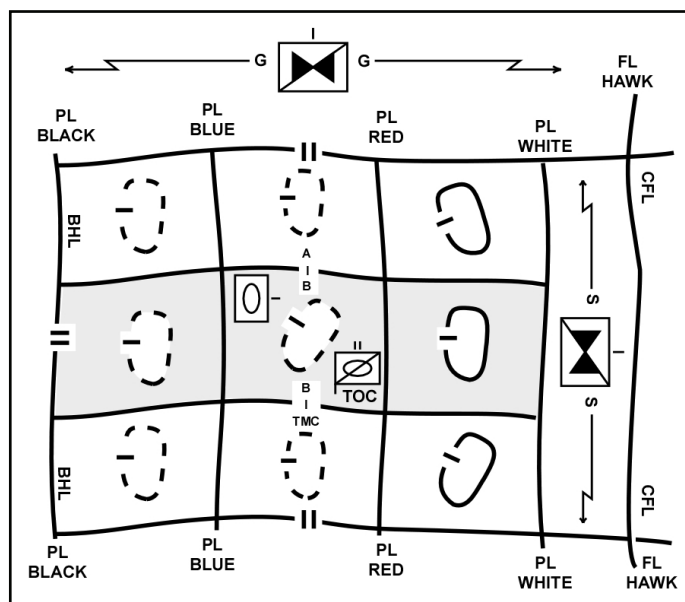

Figure 3-15. Stationary flank guard

Rear guard

3-192. A rear guard protects the exposed rear of a stationary main body. The critical tasks listed for the stationary flank guard apply for rear guard. Establishing the rear guard during retrograde operations may be done in two ways. The ARC may relieve other units in place along the FLOT as they move to the rear; or the ARC may establish a position in depth behind the main body and pass those forces through.

Moving Guard

3-193. Moving guard operations may be conducted to the front (advance), flank, and rear of the main body.

Advance guard

3-194. An advance guard for a moving force is offensive in nature. When serving as the advance guard for a moving force, the ARC develops the situation to the front along specific routes or axes to prevent surprise or premature deployment of the main body. Planning is conducted as in a zone or route reconnaissance but will usually have a more lenient engagement criterion. The ARC must have artillery coverage. The main body is normally in a movement to contact. The ARC develops the threat situation by fighting to gain intelligence. The ARC is expected to plan its part of the mission the same way it would a

zone reconnaissance. Primary emphasis is on early development of the threat situation in the area of the main body's route or axis of advance.

3-195. The protected force commander determines the interval maintained between the ARC advance guard and the main body. The ARC provides reconnaissance pull, enabling decisive operations to take advantage of any opportunities. The ARC gains contact by maneuvering as necessary to develop the situation and enable the ground force commander to make a decision whether to attack, defend, or delay based on METT-TC.

3-196. The ARC may conduct a hasty attack to defeat or destroy threat forces, but does not normally conduct frontal assaults against prepared positions. The ARC may also attack to fix or contain a threat force if such actions are within the protected force commander's intent and security guidance.

3-197. If the ARC encounters threat forces beyond its capabilities for offensive operations, it then defends, continues reconnaissance, and facilitates deployment of the protected force. It coordinates and prepares passage of elements from the protected force forward. The ARC may also delay threat forces within the depth of its AO to avoid decisive engagement while still protecting the main body. The protected force commander may even visualize the delay as a shaping operation that protects his force, while enabling it to maneuver to an advantageous position.

Flank guard

3-198. As a moving flank guard, the ARC performs the same tasks for a moving force as for a stationary force. A flank guard for a moving force advances systematically to a series of BPs or OPs parallel to the main body's axis of advance and clears the area between its route and the main body as the main body advances. Flank guards are primarily reconnaissance oriented. During a flank guard, the ARC can be used to screen between the guard force and main body. It can also be used to screen forward of the guard force during the movement to BPs. In both situations, the ARC uses a zone reconnaissance moving to successive screen lines forward of a moving force. Figure 3-16, page 3-45, shows a company conducting a flank guard for a moving force.

COVER

3-199. A covering force accomplishes all the tasks of screening and guard forces. Additionally, a covering force operates apart from the main body to develop the situation early and deceives, disorganizes, and destroys threat forces. Unlike screening or guard forces, a covering force is tactically self-contained and capable of operating independently of the main body. The ARB participates in covering force operations as part of a larger force; the ARB cannot conduct covering operations independently. Covering force operations are not typical for an ARB. See FM 17-95 for more information on cover operations.

AREA SECURITY OPERATIONS

3-200. Area security includes reconnaissance and security of designated personnel, airfields, unit convoys, facilities, main supply routes (MSRs), forward operating bases, equipment, and critical points. An area security force neutralizes or defeats threat operations in a specified area. Area security operations focus on the threat, force being protected, or a combination of the two.

3-201. This mission is used extensively in stability operations and for operations in the noncontiguous operational environment. It is also assigned around an airhead or lodgment areas following airborne, air assault, or forced entry operations. Area security may also be used to provide early warning to an isolated force that cannot tie its flanks to a friendly unit.

3-202. As an area security force, the ARC performs reconnaissance, screens, and conducts CCA to protect forces within a specified area utilizing the same methods and procedures discussed earlier. The headquarters assigning the area security mission defines the area.

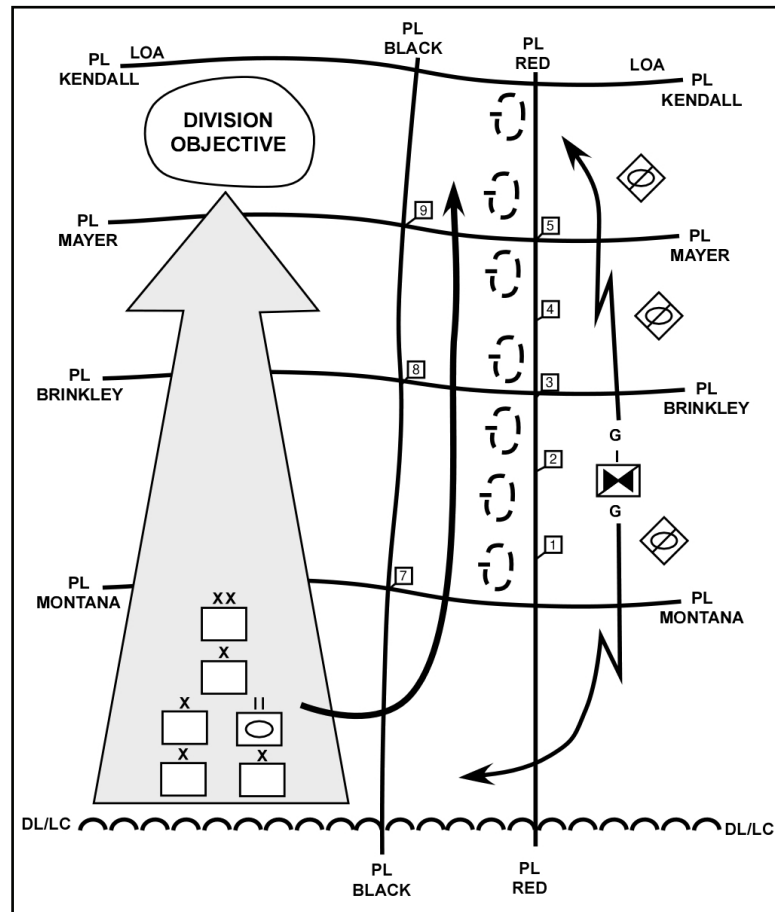

Figure 3-16. Moving flank guard

Critical Tasks

3-203. All-around security during operations is essential; however, commanders balance the level of security measures with the type and level of threat posed in the specific area. Depending of the mission, the ARC executes the following critical tasks within its capabilities to include—

- Maintain surveillance of all avenues of approach larger than a designated size into the AO.
- Maintain contact with threat or belligerent forces, not allowing threat ground elements to enter or exit the AO undetected and unreported.
- Defend the protected force or facility.
- Deter or destroy enemy forces conducting mortar, rocket, or ambush attacks.
- Protect MSRs and convoys.
- Prevent threat forces from acting against friendly forces in adjacent or noncontiguous AOs.
- Support presence operations including show of force demonstrations.
- React to civil disturbances.

Cordon and Search

3-204. Cordon and search is executed against a specific target within a given area. Frequently directed by higher headquarters or the ground component commander, it utilizes both air and ground forces to recon and secure an objective for search. The ground force establishes inner and outer cordon, referred to as rings, along with traffic control points (TCPs) and blocking positions on avenues of approach.

3-205. As applied to the cordon and search mission, the ARC provides essential capabilities to the ground force conducting the operation. The aircraft normally conduct route reconnaissance in support of ground movement to the objective with an initial observation and assessment of the situation within each objective. The ARC ensures initial observations are focused according to specific intelligence requirements. These observations might be the situation around the target building, location of a specific vehicle, or detection of anything attempting to exit the objective prior to establishment of the outer cordon. Aircraft utilize onboard sensors/video to gather requested information without alerting the search area.

3-206. Once the ground cordon is set, ARC teams provide area security outside the inner cordon and mostly beyond the outer cordon. This task keeps the ARC teams focused “out,” away from the objective searching for elements attempting to influence the ground commander’s mission. The ground commander can accept risk beyond the outer cordon refocusing ARC teams “in,” searching for snipers or other observation tasks inside the inner cordon and objective area. Once inner situations reach resolution, aircrews may return to the initial area security mission (focus out). If more than one team is in support of the cordon and search, then both tasks are executed simultaneously (figure 3-17). Once the ground element completes the mission within the objective, the ARC conducts route reconnaissance and/or convoy security along the egress route.

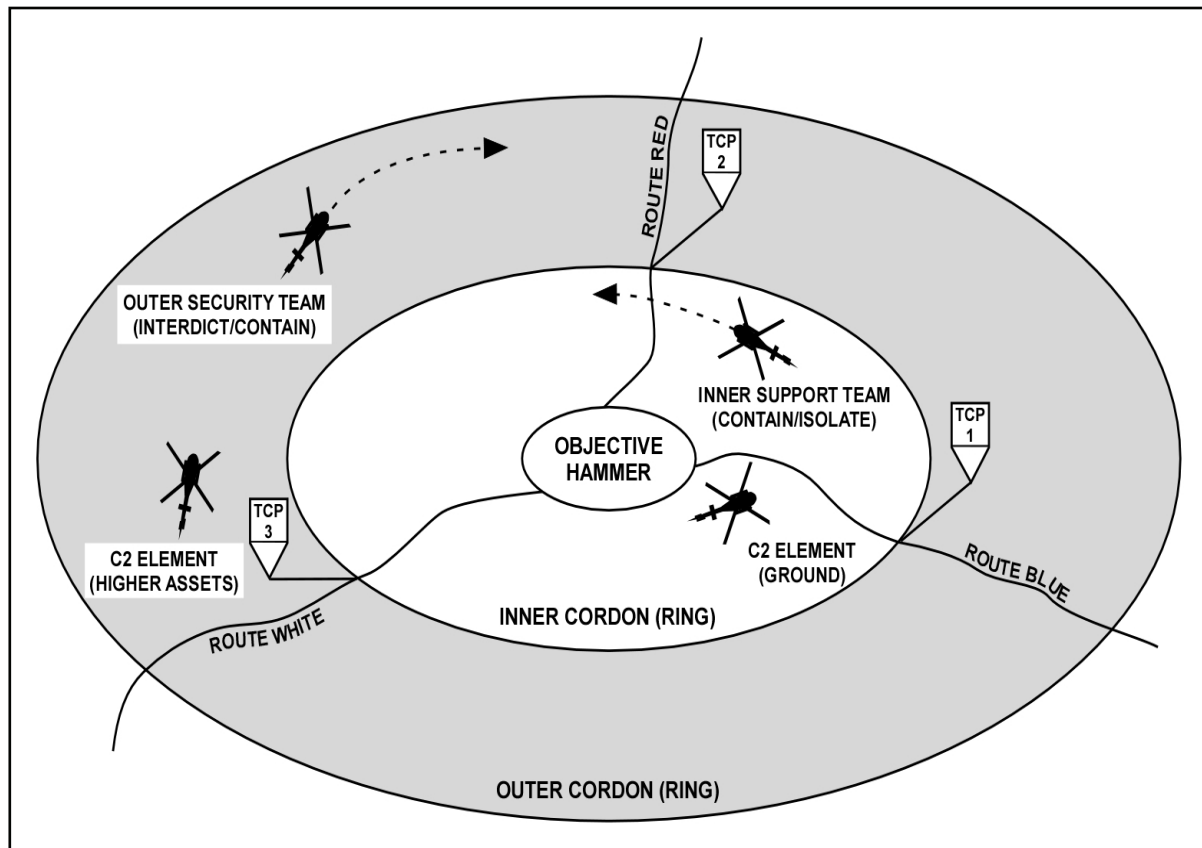

Figure 3-17. Attack reconnaissance company support of cordon and search

Pre-mission Planning

3-207. To enhance support of the ground force commander, the ARC must fully understand the ground maneuver plan. The ARC uses a cordon and search checklist to ensure all pertinent information is provided for the mission. The ground mission commander must provide the ARC the following planning information:

- Mission objective (specific area, structure, or entity).

- Objective size and location (if known) with sketch.
- Imagery of objective area (if available).
- Target list worksheet.
- No fire areas (NFAs)/restricted fire areas (RFAs).
- Clearance of fires procedures.
- ROE.
- Attack reconnaissance mission focus during cordon and search phases.
- Ground commander PIR.
- Control measures and graphics (includes common numbering system of all buildings and key structures). Positions of road blocks, support positions, and outer cordon should be included.
- Friendly marking techniques.
- PR plan.
- Mission timeline and expected duration.
- C2 plan (frequencies and call signs).
- Number and type of vehicles used in ground element.

3-208. The aviation commander in turn relays to the ground commander—

- Available assets, including ordnance available.
- Time windows of aviation coverage.
- Necessary gaps for rearm/refuel, maintenance, and fighter management.

3-209. All cordon and search missions are not planned. The ARC may receive a FRAGO to conduct a hasty cordon and search. The initial team check-in with ground elements sets the tone for the success of the mission. The attack reconnaissance teams transmit the following minimal essential information to the ground commander—

- Call signs.
- Total number of aircraft.
- Current location and ETA.
- Ordnance available.
- Available time on station (initial fuel status and necessary gaps for rearm/refuel).

3-210. The ground commander should immediately provide the aircrews with a current SITREP along with any critical updates or changes to the initial plan (if a preplanned mission).

Route Security

3-211. The ARC prevents a threat from attacking, destroying, seizing, containing, impeding, or harassing traffic along a specified route. They also prevent the threat from interdicting traffic by emplacing obstacles on or destroying portions of the route. Tasks are normally independently executed but mutually supportive. Unless the higher or area commander directs otherwise, the ARC executes critical tasks within its capabilities and limitations to include—

- Conduct continuous reconnaissance on and to the flanks of the route.
- Establish overwatch around choke points or critical points such as bridges, defiles, intersections, and roadway fills.
- Establish OPs along the route and lateral routes to monitor civilian traffic entering or traveling on the route. Instead of static OPs, teams may move continuously along the route to maintain observation.
- Conduct reconnaissance along the route to search for suspected threat positions.
- Report movement of refugees or dislocated civilians.

3-212. The ARC conducts route reconnaissance at irregular intervals to avoid developing a pattern the threat may exploit. Teams reconnoiter the route to include a zone reconnaissance to either flank. Teams

may reconnoiter in advance of ground forces or assist in screening the flanks. Planning factors and critical tasks remain the same as with a route reconnaissance.

Convoy Security

3-213. The purpose of this operation is to safeguard convoys by locating enemy forces before they can attack the convoy. The SWT conducts CCA to suppress, neutralize, or destroy ambushing enemy forces. Often the mere presence of a SWT will prevent the enemy from attacking a convoy. The SWT determines the maximum lateral distance from the route to be cleared based on enemy weapons range. The two basic methods for conducting convoy security are detached and attached.

Detached

3-214. The purpose of detached escort is to provide the ground convoy commander with real time SA of the route with sufficient time and maneuver space for him to make decisions. During detached escort the SWT is not anchored to the ground convoy, rather they conduct reconnaissance ahead of the convoy, and are focused on finding any enemy forces that can attack or influence the convoy route. The amount of time that the SWT precedes the convoy along the route is METT-TC dependent but should not leave sufficient time to allow the enemy to set up positions in previously cleared areas. The SWT searches for ambush sites, IEDs and triggermen, and report on route trafficability and bypass capability. In urban environments this can include traffic jams, road debris, and personnel on rooftops. While the detached escort may provide early warning to the convoy commander, its major disadvantages are lack of deterrence and inability to provide immediate firepower to the convoy.

Attached

3-215. The primary purpose of the attached escort is to deter enemy attack and provide immediate CCA support if the convoy is engaged. The SWT maintains freedom to maneuver but generally flies within LOS of the convoy.

3-216. Convoy security operations involve the lead aircraft or team conducting route reconnaissance in front of the convoy and the trail aircraft or team conducting security for the convoy. The purpose of the operation is to provide early warning to the convoy commander of approaching threat forces or possible ambush sites and conduct CCAs in support of the convoy commander. The convoy is escorted from the start point to the RP and reports to its higher headquarters upon the completion of the mission. Figure 3-18 and figure 3-19, page 3-49, illustrate two examples of a SWT performing a convoy security.

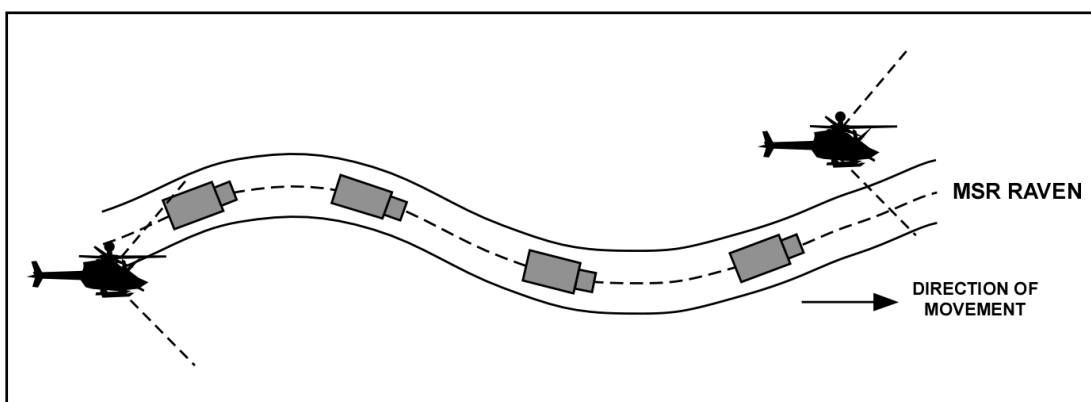

Figure 3-18. Standard convoy security technique

Note: This technique is the basic method for a SWT or section conducting convoy security and should be modified as necessary to provide maximum security and SWT survivability. Lead flies up to 1 kilometer ahead of the convoy to provide early warning of enemy or obstacles. The trail team member flies behind or over the convoy to provide security, facilitate C2, and maintain overwatch of the forward team member. Each team member's flight path is based on METT-TC (including convoy speed, terrain, and expected threat). Advantages of this technique include freedom of maneuver, unpredictability, and, to a limited extent, the early warning capabilities of the detached escort. The primary disadvantage is the increased vulnerability of the SWT based on the inability to provide continuous mutual overwatch.

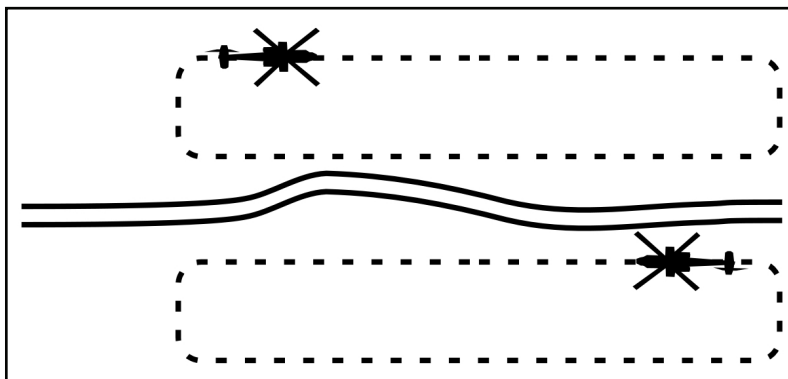

Figure 3-19. Butterfly pattern convoy security technique

Note: When utilizing this technique each team member flies continuous racetrack patterns on opposite sides of the route. The distance flown from the route and the convoy is METT-TC dependent. Patterns are flown so that the SWT maintains continuous LOS with each other. This technique provides increased deterrence from enemy attack against the SWT in addition to the convoy. Primary disadvantages are reduced freedom of movement and increased predictability.

3-217. Based on planning and/or coordination time available, the ground mission commander must provide the ARC with the following planning information:

- Call signs and frequencies.
- Convoy route (designation, limits, alternate routes, and time of day to be used).
- Composition and disposition of convoy (number and type of vehicles, crew-served weapons available).
- Actions on contact (what the convoy will do if ambushed).
- Graphic control measures.
- Ground commanders scheme of maneuver with task and purpose.
- Provide a SITREP when the teams arrive on station, to include—
 - Current situation.
 - Threat forces to include paramilitary and criminal organizations.
 - Threat trends and recent activities.
 - Potential ambush sites.
 - Civilian traffic to include refugees and potential congested areas.
 - Communications to include visual signals.

- 3-218. The ARC commander, in turn, provides the ground commander with the following information:
- Available assets (number of aircraft and ordinance available).
 - Time windows of aviation coverage.
 - Necessary gaps for rearm/refuel, maintenance, and crew rest.
 - Determines critical areas; such as danger areas, defiles, choke points, PLs.
 - Identify secondary routes and bypasses to the convoy commander if necessary.
 - Assist convoy commander in maintaining C2 of the convoy (rate of march, interval, security, and communications).

Aerial Escort

3-219. Aerial escort missions are flown to protect helicopters conducting air assault, MEDEVAC/CASEVAC, or air movement missions. Escorted formations may range from a single aircraft to a large air assault formation. The purpose of this mission for the SWT is to protect the escorted formation by locating the enemy before they can affect the flight or by deterring enemy fire. If the escorted flight is engaged the SWT must react quickly to destroy, neutralize, or suppress the enemy before effective fire can be directed against escorted aircraft. Upon reaching the objective area, the SWT immediately transitions to area security operations. There are two basic aerial escort techniques—detached and attached.

Detached

3-220. Detached escort involves flying air route reconnaissance ahead of the escorted aircraft. The goal is to locate all enemy forces along the route. For air assault security, the SWT task is to locate all enemy forces that can influence the PZ, route, LZ, and objective area. Once located the enemy can be engaged or reported and bypassed according to METT-TC. The position of the enemy is passed to the escorted formation to facilitate a change in mission timeline or flight route as necessary. If the escorted formation is already on the route the AMC must decide to hold along the route, continue an alternate route, or return to base. The gap between the SWT and the escorted formation is primarily a function of the time required by the SWT to conduct reconnaissance along the route. The complexity of the terrain, amount of concealment available for the enemy, speed of the escorted formation, and SWT station time are all factors in determining route reconnaissance time. The time between flights should be kept to a minimum to prevent the enemy from establishing positions along previously reconnoitered portions of the route.

3-221. The primary advantage of the detached escort is additional freedom of movement and time available for the SWT to locate enemy along the route. The major disadvantage of this technique is a lack of deterrence or ability to provide immediate firepower in response to threats against the escorted formation. Other disadvantages are communication problems that may arise between the SWT and the escorted formation due to distance and/or terrain and losing the element of surprise.

3-222. The detached escort is best employed against a route/threat combination where personnel and equipment can be readily distinguished as enemy. Unconventional enemy forces along the route, especially in urban environments, may be difficult or impossible for the detached escort to locate and the SWT's presence along the route may tip off the enemy to the follow-on formation. In any case, lack of enemy contact does not ensure the absence of enemy along the route.

Attached

3-223. Attached escort involves the SWT flying with the escorted formation as a single flight. The primary purpose of the attached escort is to deter enemy fire or conduct hasty attack in reaction to enemy contact or engagement. The primary position for the SWT is to the rear of the escorted formation. This allows the SWT to scan the flanks of the formation and provide immediate suppressive fire if necessary. If available a second SWT should fly in the front of the formation to locate threats and provide additional deterrence. If necessary according to METT-TC, a single SWT may split up to fly in the front and rear of the supported formation; however this is not the preferred technique because it prevents the SWT from providing mutual support. While the SWT AMC is free to configure and maneuver his team as necessary to accomplish the mission, the standard escort formation for a single SWT is the “inverted Y” formation

(figure 3-20, page 3-51). The SWT flies a combat spread formation off of the last aircraft in the escorted formation. Each escort aircraft is primarily responsible for scanning forward and on the flank of its side of the escorted formation.

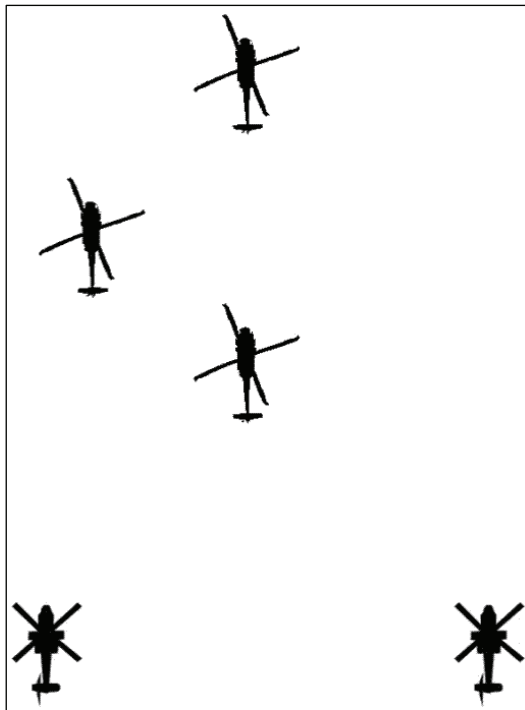

Figure 3-20. Inverted “Y” aerial escort formation

3-224. Reaction to enemy contact is METT-TC dependent. The aircraft on the same side as the enemy fire normally assumes tactical lead to conduct BCMs and initiate the attack. When supporting VIP missions, the SWT team leader should be briefed on the location of the principle and maneuvers his team to provide maximum security for that aircraft. The primary responsibility is to protect the flight (or principle) rather than becoming decisively engaged. However, the SWT should make every effort to destroy the enemy force when it can do so and still remain in a position to complete the primary mission. This is especially true in counterinsurgency operations. Each engagement that the enemy survives, successful or not, may serve to bolster support for their cause and further develop enemy TTPs.

3-225. Mission planning should include the SWT and escorted formation conducting a face to face air mission brief. The briefing covers topics including formation, communication plan, aircraft lighting and NVDs, contingencies, actions on contact, and rally procedures. Possible fratricide from door gunner fire on the SWT should be briefed. Formation airspeed is another important planning factor especially during high altitude operations. The airspeed should be slow enough to allow the SWT freedom to maneuver, orient on suspected threats, and maintain position near the flight without exceeding operating limits. When supported by the OH-58D the only choice for the escorted formation is to fly a reduced airspeed or select the detached escort.

3-226. The primary advantage of the attached escort is the combination of deterrence and ability to provide immediate suppressive fires. The primary disadvantage is the reactive rather than proactive nature of the SWT's actions. The attached escort is equally applicable against conventional and unconventional forces.

Combined

3-227. The combined escort is a combination of the detached and attached escort techniques. The primary advantage is the increased security and combat power. The primary disadvantages are complexity of planning and coordination and the amount of SWT assets needed to perform the mission.

Air Assault Security

3-228. The ARC integrates into the scheme of maneuver for the conduct of reconnaissance, security, or overwatch operations during all phases of the air assault and/or air movement. The successful execution of the operation is based upon a careful analysis of the factors of METT-TC and a detailed, precise, reverse planning sequence. Planning begins with the ground tactical plan and works backwards to the staging plan as indicated in figure 3-21. Reverse planning is imperative, as each successive planning step impacts the phase that precedes it. The landing plan, for example, helps air assault planners determine the sequence and composition of lifts during the air movement phase. ARC aircrews should review the air assault landing plan for discussion and decision on the best schemes of maneuver to optimize lift asset protection.

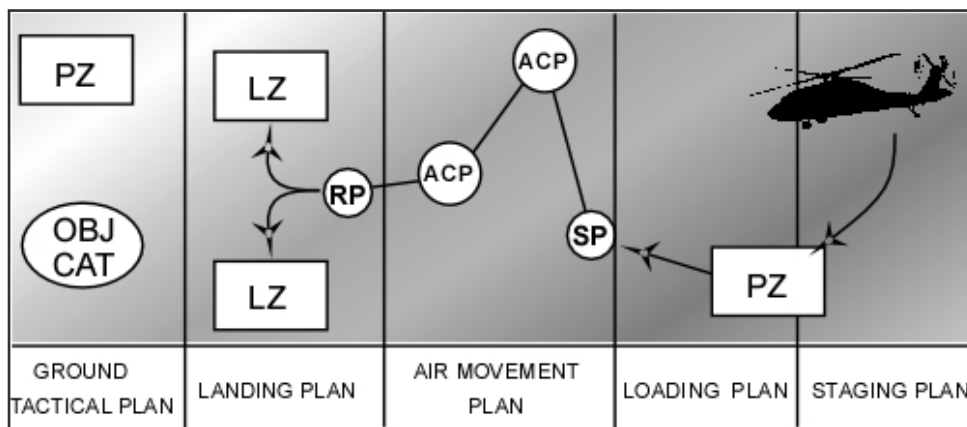

Figure 3-21. Air assault planning stages

Staging plan

3-229. The ARC may conduct PZ reconnaissance and screening operations to provide early warning and limited security while friendly companies form on or near the PZs. If threat forces are close by or contact is likely, the ARC conducts area security and CCA with ground maneuver forces to increase its ability to repel threat forces.

Loading plan

3-230. The ARC conducts PZ reconnaissance before the arrival of assault helicopters. Once the PZ is cleared, the ARC may screen a vulnerable flank or likely avenues of approach. Table 3-4 provides examples of PZ markings for security elements to reference.

Table 3-4. Example marking techniques for pickup zones

Position in PZ	Daylight Marking	Night Marking
PZ entry	Guide and sign	Guide with 2 blue chemical lights
PZ control	M998 and VS17 panel	2 green chemical lights on antenna
Aid station	M997	Steiner device
Chalk stage points	PZ control party guides/signs	Guide/blue chemical light per chalk
Lead touchdown point	VS 17 panel, smoke	Inverted Y, IR flashlight
Chalk touchdown points	Soldier on knees with raised rifle	IR chemical light per aircraft
Obstacles	Notify pilots on radio	Red chemical light ring around obstacle
Loads to be picked up	Hook up team on loads	Swinging IR chemical light per load

Air movement plan

3-231. A SWT may precede the air assault element along the air route by performing a detached escort followed by area reconnaissance of the LZs and the objective, depending on the factors of METT-TC.

Along the route, they locate any previously unknown enemy AD weapons and radar, and suppress those systems or develop a bypass route for the air assault element. ARC elements may also provide pertinent information on threats to flight, including natural and manmade obstacles. Depending on the threat, teams may be tasked with performing an attached escort during the air movement phase.

3-232. ARC elements can also provide early warning of the threat's approach and can engage the threat with organic weapon systems or indirect fires. They may also be assigned responsibility for coordinating the recovery of downed aircrews with other elements of the TF.

Landing plan

3-233. The ARC conducts area reconnaissance of the objective area prior to the assault landing and then transitions to area security and CCA as needed. During low threat scenarios when surprise is paramount, the SWT arrives on the objective to coincide with the sound of the approaching assault aircraft (30 to 180 seconds out). This technique can be utilized by prior coordination and timing or from the attached escort formation (figure 3-22). The SWT's primary focus when utilizing this technique is locating and/or destroying enemy personnel attempting to leave the objective area.

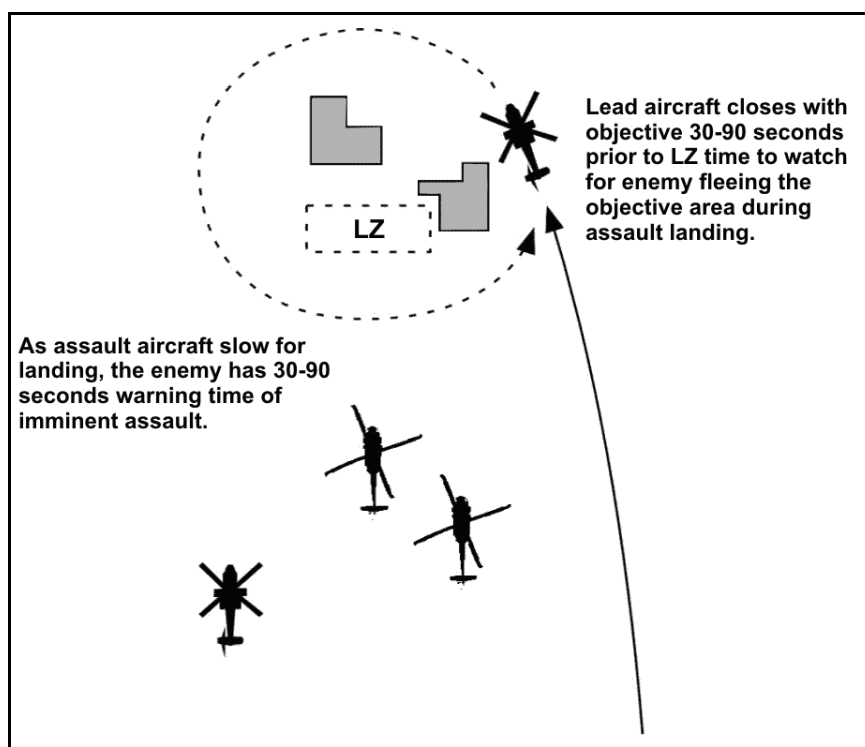

Figure 3-22. Attached escort landing zone reconnaissance

3-234. A SWT gives final go/no go for landing in the LZ based on conditions and, most importantly, enemy situation. The SWT must ensure they are deconflicted with the assault elements and are in position to provide covering fires. The SWT may also (METT-TC dependant) drop aids, such as chemical lights, to mark landing sites.

Ground tactical plan

3-235. As the ground force moves forward and seizes its objective, the ARC may again be tasked to conduct reconnaissance, security, and attack operations. ARC teams can rapidly reconnoiter the ground route to the objective as well as the objective itself from standoff ranges. The ARC screens the ground force's movement and provides CCA on the objective. The company also provides overwatch during the extraction of ground elements.

Fire Support

3-236. FS is an important consideration the ARC must take into account during all phases of the air assault. Planned fires along the route of flight protect aircraft against known or suspected enemy positions. These fires may be intense and of a duration that destroys or suppresses enemy forces but does not interfere with aircraft as they fly past specific locations. They are planned on areas and fired on a time schedule or on call. Fire plans cover PZs, LZs, flight routes, and suspected enemy avenues of approach to LZs. FS plans include lethal and nonlethal J-SEAD, CAS, and smoke. The ARC commander works with the TF to ensure the friendly FS elements do not use ordnance that obscures aircrew vision, especially during NVD missions.

TIME AND SPACE CONSIDERATIONS FOR RECONNAISSANCE AND SECURITY MISSIONS

3-237. Reconnaissance and security missions require detailed planning which includes calculating the area an ARC can screen or reconnoiter. The size of the area depends on METT-TC, mission duration, and aircraft/aircrew availability. While every mission and situation is different, this section discusses the general methods of calculating this area of coverage and screen line planning. With modification, the method applies to other reconnaissance and security missions by ground or other assets like UAS.

3-238. The area a company can screen extends from a width of 3 to 5 kilometers (what a single air-reconnaissance team can see from one OP) to a maximum of 30 kilometers. Under the optimum conditions of wide-open terrain, excellent visibility, and all available aircraft screening and rotating through the FARP, a company can screen along 30 kilometers for 8 to 12 hours. However, wide-open terrain and good visibility are not the norm, and lightly-armed attack reconnaissance aircraft often require the commitment of at least two of six available helicopters as a reserve to destroy or repel enemy reconnaissance teams.

3-239. A series of aircraft teams, rather than the entire unit, conduct reconnaissance and security missions in several NAIs over a wide geographic area. Teams may not have a well-developed picture of the enemy situation before initiating the mission. Ammunition loads and weapons mix are determined by METT-TC. The team also uses artillery to help develop the situation and discover the enemy's disposition.

3-240. As a general rule, a company screens with one team of two aircraft on the screen line; one team of two aircraft moving to, in, and from the FARP; and two aircraft in reserve. This gives the commander the flexibility to reinforce the screen line with an additional team if necessary. With this force disposition and the optimum conditions of wide-open terrain and excellent visibility, the ARC can cover 15 kilometers. The area screened could be as small as the area observed from a single OP (3 to 5 kilometers).

SCREEN PLANNING EXAMPLES (8-12 HOURS)

3-241. Figure 3-23 depicts a single air-reconnaissance team screening from OP 2. The terrain is constricted and the avenue of approach follows a valley. The standoff area is about 3 kilometers and the observable area is 5 kilometers. The next avenue of approach is in the next valley, 10 kilometers away. Concealed air route availability prevents the air-reconnaissance team from moving to the next valley and back again before the enemy can pass through the observable area. This requires the air-reconnaissance team to maintain continuous observation from OP 2. Because it is mountainous terrain and the aircraft munitions load is too small to repel expected enemy reconnaissance forces, a rapid reaction team is on standby to repel or destroy enemy reconnaissance forces. Team 1 observes while team 2 moves to, in, and from the FARP. Team 3 positions itself where it can react to any enemy force observations. Alternate kill zones are selected south of the observed area in case the enemy moves faster than expected through the observable area.

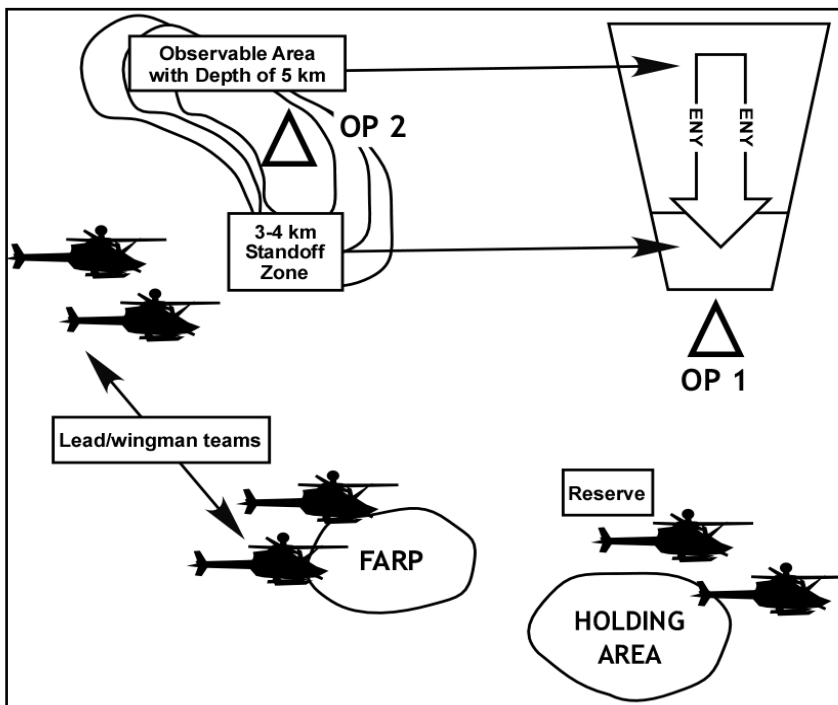

Figure 3-23. Screen with rapid response team

3-242. Figure 3-24, page 3-56, reflects two teams screening along OPs 1 to 4. The open terrain allows excellent standoff and observable areas. The standoff area is about 3 kilometers and the observable area is about 5 kilometers along each avenue of approach. The distance between OPs is 15 kilometers. An attack reconnaissance team from the squadron provides the reserve. The air-reconnaissance teams rotate through the screen areas and FARP. Team A moves to the area defined by OPs 1 and 2, team B moves to the area defined by OPs 3 and 4. They observe for 40 minutes and then team A is relieved by team C, team B is relieved by team A, and team B moves to the FARP. This rotation continues until the ART is relieved by another ground or air unit, contact is made, the mission is terminated, or until crew endurance requires the ART to move to the AA.

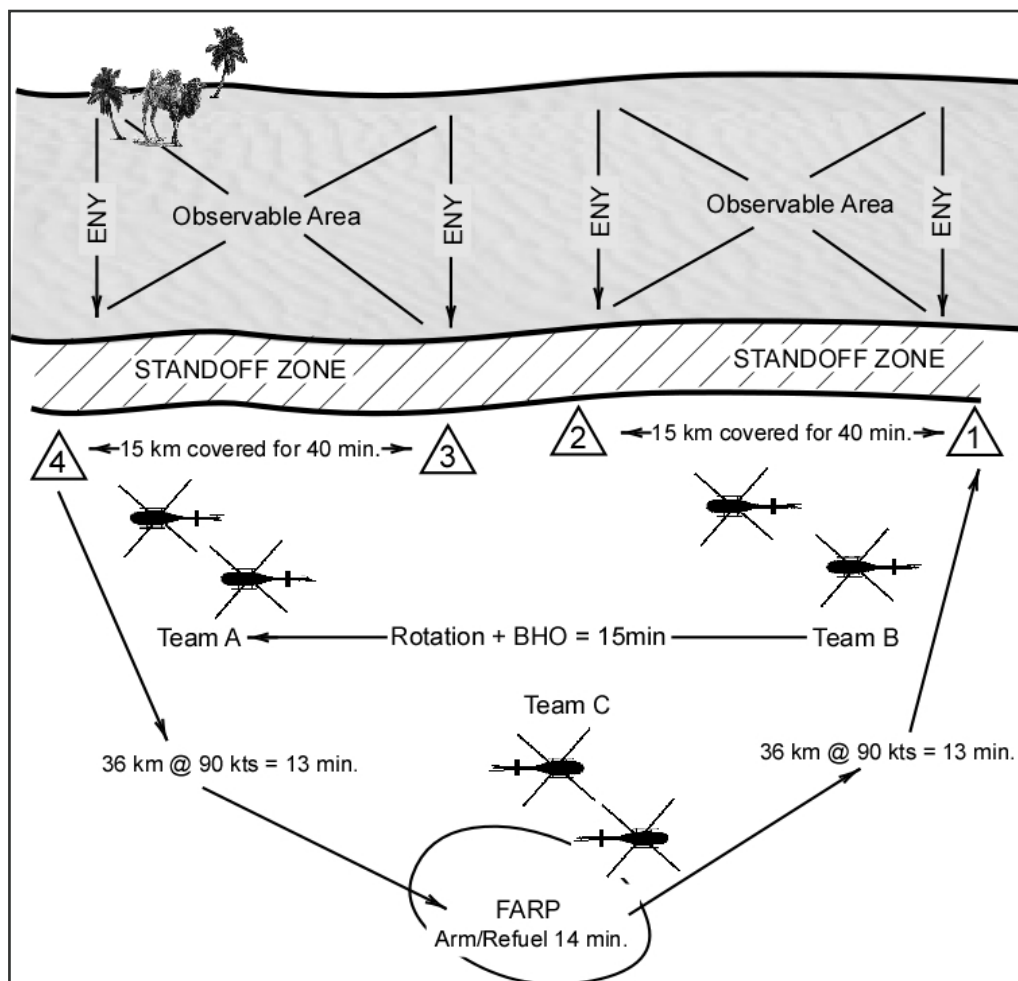

Figure 3-24. Maximum screen line option

SCREEN PLANNING CALCULATIONS (8-12 HOURS)

3-243. The observable area and enemy's assumed movement speeds determine friendly forces observation criteria for selected OPs. Air speed and OP occupation times determine the time it will take to move between OPs and into position. Each requires knowledge of the enemy, careful planning, and adherence to schedules. The challenge is to achieve the optimum screen line size that can be adequately observed.

3-244. In the scenario depicted in figure 3-24, teams A, B, and C rotate between OPs 1 and 2, OPs 3 and 4, and the FARP. Each team will man the screen line for a total of 55 minutes while the third team travels to the FARP (13 minutes), rearms and refuels (14 minutes), returns to the OP (13 minutes), and teams execute BHO/rotation (15 minutes).

3-245. Each team can cover two OPs, because each team can travel from its first OP to the second, observe, and then return to the first OP before the enemy can traverse the observable area. Those calculations are as follows:

- An enemy force moving 20 kilometers per hour will require 15 minutes to traverse the observable area.
- The air-reconnaissance team requires about seven to eight minutes at 60 knots to travel between each OP and about one to five minutes moving into the OP, unmasking, observing, masking, and

moving out of the OP, providing a two minute time buffer for the air-reconnaissance team to move between OPs.

3-246. In the scenario depicted in figure 3-24, page 3-56 a reaction force is required and the time required to travel between OPs is too long to cover more than one at a time, requiring the entire reconnaissance team to cover that single approach.

3-247. The formula for planning times is outlined in figure 3-25. The formula for planning ground unit speed is in figure 3-26.

FLIGHT TIME COMPUTATION:

$$T = \frac{D \times 60}{S \times 1.85}$$

T = Time in minutes
 D = Distance in km
 S = Groundspeed in kts

Airspeed-groundspeed conversion:

Note: The number 60 converts hours to minutes. The number 1.85 converts knots to km/hour. Round fractions to the nearest whole minute.

Example: Given 50 km distance from OP 4 to the FARP at an average groundspeed of 90 kts.

$$T = \frac{50 \text{ km} \times 60}{90 \text{ kts} \times 1.85}$$

T = 3000/166.5 = 18 minutes of flight time from OP 4 to the FARP at 90 kts.

Sample groundspeeds in kts converted to rounded off km/hour and km/minute:

65 kts = 120.4 km/hr = 2.0 km/min.....	100kts = 185.2 km/hr = 3.1 km/min.
80 kts = 148.2 km/hr = 2.5 km/min.....	110 kts = 203.7 km/hr = 3.4 km/min.
90 kts = 166.7 km/hr = 2.8 km/min.....	120 kts = 222.2 km/hr = 3.7 km/min.

Figure 3-25. Computing en route time

To compute the time required for an enemy or friendly ground unit to pass through an observable area, use the following:

Observable area in km x 60 = time in minutes for ground unit to pass.
 Groundspeed in km/hour.

Example: If the observable area is 5 km and the enemy unit's groundspeed is observed at 20 km/hour, find how long, in minutes, it will take for the enemy unit's lead elements to pass through the observable area.

Observable area = 5 km, groundspeed = 20 km.hour.

$$\frac{5 \times 60}{20} = \frac{300}{20} = 15 \text{ minutes}$$

Figure 3-26. Computing ground unit movement time

SECTION V – ATTACK OPERATIONS

3-248. An attack is an offensive operation that destroys or defeats enemy forces, seizes and secures terrain, or both. When the commander decides to attack or the opportunity to attack occurs during combat operations, the execution of that attack must mass the effects of overwhelming combat power against selected portions of the enemy force with a tempo and intensity that cannot be matched by the enemy. The resulting combat should not be a contest between near equals. The attacker must be determined to seek decision on the ground of his choosing through the deliberate synchronization and employment of his combined arms team (FM 3-90).

3-249. Attack reconnaissance battalions conduct attack operations during both offensive and defensive operations. The battalion contributes to shaping the operational environment by assisting in finding, fixing, and engaging the enemy. During meeting engagements, attack reconnaissance units fight for intelligence and develop the situation. The battalion supports friendly ground forces in contact through CCAs.

ATTACK FORMS

3-250. The amount of planning time available determines which form of attack the battalion executes.

HASTY ATTACK

3-251. A hasty attack is an attack launched with the forces at hand and with minimal preparation to maintain the momentum or take advantage of the enemy situation. The objectives are to overwhelm the enemy quickly and seize the initiative. Speed is paramount; if momentum is lost, the hasty attack can fail. An attack with speed, audacity, and boldness can offset the lack of thorough preparation. The hasty attack depends on timely and accurate information as well as speed. When contact is made, commanders must immediately evaluate their chances of success. Attacking rapidly before the threat can react often brings success even when the threat possesses local combat superiority.

3-252. Hasty attacks often result from unexpected enemy contact. Unexpected contacts occur most often during reconnaissance, security, movement to contact, and in response to an enemy attack. In all cases, the SWT conducts hasty attacks to rapidly develop the situation or overwhelm the enemy before it can adequately prepare. SWTs normally conduct hasty attacks without knowledge of the attack time, location, and threat until shortly before the mission or until making enemy contact. SOPs, battle drills, and contingency planning based on probable enemy actions and IPB improve the success of hasty attacks.

3-253. When contact is made, the AMC/ARC commander must evaluate the chances of success in conducting a hasty attack and possible alternative COAs including maintaining contact and conducting a BHO with a more capable force or bypassing the enemy force. Units pass SA information to higher headquarters to determine whether the hasty attack will be reinforced.

3-254. When the attack begins, SWTs develop the situation quickly and employ direct and/or indirect fires, to include joint fires. These actions also provide suppressive fires for maneuvering ground elements. Air reconnaissance provides operational environment information and situational updates on which the commander can base immediate decisions concerning the attack. The battalion facilitates the sequencing of supporting assets into the attack. If CAS assets are available, an immediate JAAT may be executed.

Critical Tasks

3-255. The ARC conducts a hasty attack to maintain momentum for current and future operations. This momentum relies on the ARC's ability to destroy or force the threat to withdraw while maintaining combat power. The ARC accomplishes critical tasks to ensure the success of the hasty attack. These tasks may include—

- Performing actions on contact.
- Establishing weapons delivery technique.
- Designating security responsibilities.

- Coordinating for indirect fires (to include joint).
- Developing direct fire plan and fire distribution technique to be utilized.
- Determining FARP rotation.
- Conducting BHO to ground elements if necessary.
- Reporting all combat information to higher.

DELIBERATE ATTACK

3-256. A deliberate attack is planned and carefully coordinated with all involved elements to provide synchronization of combat power at the decisive point. The deliberate attack requires thorough reconnaissance, evaluation of all available intelligence and relative combat strength, analysis of various COAs, and other factors affecting the situation. To conduct a successful deliberate attack, the ARC must effectively integrate with the overall ground scheme of maneuver, or the joint, operational, or tactical plan to shape the enemy prior to ground force contact.

3-257. The ARC is generally employed as a highly mobile and lethal combat multiplier that provides the TF and BCT commander aerial firepower, agility, and shock effect. ARCs conduct shaping with joint fires and air attacks to disrupt enemy elements forward or to the flanks of friendly ground elements.

Critical Tasks

3-258. Critical tasks the ARC accomplishes during a deliberate attack include—

- Conducting TLP and mission planning.
- Performing aerial passage of lines or cross LD.
- Performing reconnaissance of ABFs and SBFs.
- Gaining and maintaining enemy contact.
- Performing actions on contact.
- Fixing the enemy.
- Establishing weapons delivery technique.
- Designating security responsibilities.
- Integrating joint fires.
- Disrupting/neutralizing/destroying the enemy.
- Developing direct fire plan and fire distribution technique to be utilized.
- Conducting BHO.
- Reporting all combat information to higher.

ATTACK MISSIONS

3-259. While an IA is used against specific targets out of contact with friendly forces, CCAs quickly focuses aerial firepower onto enemy forces in the close fight to support friendly ground maneuver.

CLOSE COMBAT ATTACK

3-260. CCA is defined as a coordinated attack by Army aircraft against targets that are in close proximity to friendly forces. During CCA, the ARC/SWT engages enemy units with direct fires that impact near friendly forces. Targets may range from tens of meters to a few thousand meters from friendly forces. CCA is coordinated and directed by a team, platoon, or company-level ground unit using the standard CCA brief (table 3-5). Once the aircrews receive the mission from the ground commander, they develop a plan then engage the enemy force, while maintaining freedom to maneuver. Due to capabilities of the aircraft and the enhanced SA of the aircrews, terminal control from ground units or controllers is not necessary. CCA is not synonymous with CAS.

Table 3-5. Close combat attack checklist for ground commander

CLOSE COMBAT ATTACK BRIEF (Ground to Air)
1. Observer/Warning Order: “_____ . THIS IS _____ . FIRE MISSION. OVER.” (Aircraft) (Observer C/S)
2. Friendly Location/Mark: “MY POSITION _____ . MARKED BY _____ .” (TRP, Grid, etc.) (Strobe, Beacon, IR Strobe, etc.)
3. Target Location: “_____ .” (Bearing [magnetic] & Range [meters], TRP, Grid, etc.)
4. Target Description/Mark: “_____ . MARKED BY _____ . OVER.” (Target Description) (IR pointer, Tracer, etc.)
5. Remarks: “_____ .” (Threats, Danger Close Clearance, Restrictions, At My Command, etc.)
AS REQUIRED: 1. Clearance: Transmission of the CCA brief is clearance to fire (unless Danger Close). Danger close ranges are in accordance with FM 3-09.32. For closer fire, the observer/commander must accept responsibility for increased risk. State “CLEARED DANGER CLOSE” on line 5. This clearance may be preplanned. 2. At my command: For positive control of the gunship, state “AT MY COMMAND” on line 5. The gunship will call “READY FOR FIRE” when ready.

3-261. Effective planning, coordination, and training between ground units and armed aircraft maximize the capabilities of the combined arms team, while minimizing the risk of fratricide. The key to success for enhancing air-ground coordination and the subsequent execution of the tasks involved begins with standardizing techniques and procedures. This procedure is best suited for units maintaining a habitual combined arms relationship during training and war. However, ARCs can provide CCA to any unit regardless of training level.

Characteristics

3-262. Characteristics of a CCA include—

- Conducting fire and maneuver in close support of ground forces.
- Providing complementary fires and maneuver while taking advantage of terrain, standoff, and ground forces for protection.
- Providing reinforcing fires.
- Continuing development of dynamic situation.
- Extending the tactical reach of maneuver forces, particularly in urban and other complex terrain.
- Presenting the enemy with multiple/simultaneous dilemmas from which it cannot escape.
- Establishing and control the operating tempo (OPTEMPO) of the fight.
- Providing extended acquisition range and lethality to the force after contact is made.
- Aviation OPCON to ground forces as situation dictates.

Critical Tasks

3-263. Critical tasks accomplished during conduct of a CCA include—

- Conducting check-in brief to gain friendly and enemy SA.
- Positively identifying friendly and enemy positions and develop hasty fire control measures.
- Synchronizing attack with ground commander to ensure mutually supporting fires and maneuver.
- Maintaining standoff outside effective range of predominant enemy weapon system.
- Using terrain to vary headings of attack runs to remain unpredictable.
- Providing ground commander with BDA and effects assessment with follow-on recommendation for reattack of end of mission.

3-264. Three key elements form the foundation for conducting CCA with ground maneuver forces—CCA FRAGO, check-in brief, and the CCA brief.

Close Combat Attack Fragmentary Order

3-265. The CCA FRAGO is critical if the planning process is hasty. It is issued to the ARC commander or AMC when the team is inbound by the ground force in contact. It contains all the information needed to complete the mission and paints a clear picture of the current friendly and enemy situation, assigns a clear task and purpose, and communicates the identification (friend or foe) signals utilized. The FRAGO is issued as a no change or contains any changes occurring since the final conditions check. The CCA FRAGO includes—

- Situation.
 - Enemy.
 - Friendly.
- Mission.
 - Task.
 - Purpose.
- Coordinating instructions.
 - Friendly location.
 - Friendly marking.
 - Enemy location.
 - Enemy marking (how friendly units will mark the enemy).
 - C2 net for confirmation/commands.
 - Clearance of fires approval authority on the ground (call sign, location, and frequency).

Check-in brief

3-266. The check-in brief gives the ground commander information on the air reconnaissance team's restrictions or limitations. It is used each time a new team arrives on station. It is especially useful when a new team arrives with a different task organization, ammunition configuration, station time, or optical capability than was previously briefed. The check-in brief includes—

- Identification. “(Ground commander), this is the (ARC commander/AMC).”
- Team composition, location, and ETA (include type and number of aircraft in the team).
- Munitions available (include type and amount of ordinance).
- Station time/special capabilities (such as NVGs, TIS, AIM-1).
- A request for ground SITREP, which includes UAS activity.

Close combat attack brief

3-267. The CCA brief is used to initiate the CCA. It involves communication between the ground commander and team conducting the attack. The CCA brief is crucial in the prevention of fratricide and destruction of the enemy. The CCA brief allows the ground maneuver forces to communicate and

reconfirm to the attack reconnaissance teams the exact location of friendly and enemy forces. Marking techniques vary from one ground unit to another. Common means of marking friendly units include VS-17 panels, meal, ready to eat (MRE) heaters, IR strobes, IR chemical lights (chemlights™), and glint tape; all work well depending on terrain, foliage, and relative location of the SWT teams to the ground forces. See appendix B for target and friendly marking methods.

3-268. The CCA brief is initiated by the ground commander in accordance with table 3-5, page 3-60.

3-269. The attack reconnaissance team provides the ground commander with the following response (table 3-6):

Table 3-6. Attack reconnaissance team response

Observer identification	Ground commander, this is aircraft, CCA, out.
Friendly location and position mark	Your position is PM 1342 5786, marked by strobe, out.
Target location, target mark, remarks	Target is _____ degrees, _____ meters, One mortar team in the open, marked by IR pointer, At your command, out.

3-270. After completion of CCA, aircrew provides BDA and reattack/end of mission recommendation to ground commander.

3-271. The AMC/ARC commander and ground unit key leaders must consider the risk to friendly forces before weapon selection and engagement. If friendly forces are in the lethality zone, the ground leader must be precise in describing the target that aircraft are to engage and should warn aircrews of the proximity of those forces. The AMC/ARC commander must be aware of his aircrews' skills in delivering fires near friendly forces and visualize exactly where those friendly units are located.

3-272. Engagements at ranges of danger close or less require extremely close coordination and positive identification. Special precautions must be taken when delivering direct fires on targets within these ranges, but it does not prohibit delivery of munitions at ranges short of danger close. Accurate delivery of munitions is essential when engaging at danger close ranges and requires higher crew training standards. FM 3-09.32 designates danger close range for Army aircraft systems as—

- Hellfire, 105 meters.
- Rockets, 240 meters.
- 30-mm, 40 meters.

3-273. Once coordination between the ground unit and the SWT is complete, the team lead develops the attack plan for aircraft within the team. Planning considerations include—

- Weapons delivery technique.
 - Running.
 - Diving.
 - Hovering.
- Attack pattern/direction of attack.
 - Racetrack (turns/breaks).
 - Cloverleaf (turns/breaks).
 - L-attack (turns/breaks).
- Munitions.
 - Type of target.
 - Minimize collateral damage.
- Attack ranges.
 - Bump point.
 - Start fire point.
 - Break/stop fire point.

- Team support.
 - Cover only.
 - Same munitions.
 - Other instructions.

3-274. During engagement, open communication and continuous coordination with friendly ground elements are required to ensure the desired effect. Coordination of direct and indirect fires from all participants produces the most efficient results in the least amount of time with the least risk to all involved. This coordination includes CAS and any other joint fires that may be employed.

3-275. Since many CCAs are conducted as hasty operations, planning may be very limited to provide in-time support to the ground element. During a hasty CCA, after location of friendly elements and the threat has been established, the initial team call may be as simple as, “inbound 360, 80 knots, rockets, right break.” Following the initial engagement, continuous communications between team members includes calling bumps, breaks, and reattack directions. Team training and battle drills are critical to the effective conduct of the hasty CCA by SWT elements.

3-276. Although the Army does not consider its helicopters a CAS system, they can conduct attacks employing CAS Joint TTP when operating in support of other forces. SWTs should be familiar with CAS procedures as the supported ground unit may not be familiar with the CCA brief. JP 3-09.3 provides further guidance for CAS Joint TTP.

INTERDICTION ATTACK

3-277. An IA is an attack by Army aircraft to divert, disrupt, delay, degrade, or destroy enemy combat power before it can be used effectively against friendly forces. It can take place at any point in the operational environment and can be hasty or deliberate. IA is conducted at such a distance from friendly forces that detailed integration with ground forces is not needed. IA combines ground based fires, attack aviation, unmanned systems, and joint assets to mass effects, isolate and destroy key enemy forces and capabilities. Deliberate IAs are focused on key objectives and fleeting high value targets such as enemy C2 elements, AD systems, mobile, long-range surface missiles, surface-to-surface missiles (SSMs), artillery, and reinforcing ground forces. Hasty IAs are the result of sudden enemy contact or as a result of enemy attack. The purpose of a IA is to deny the enemy freedom of action, support friendly maneuver, and destroy key enemy forces and capabilities.

Critical Tasks

- 3-278. IA tasks may include—
- Performing hasty/deliberate attack planning.
 - Establishing triggers for commitment of forces.
 - Establishing bypass, engagement, and success criteria.
 - Conducting EA development and direct fire planning.
 - Isolating and destroying key enemy forces and capabilities.
 - Synchronizing complimentary FS and CAS to enable maneuver to and from the target.
 - Focusing on key objectives and fleeting high value targets.
 - Assessing BDA.

JOINT AIR ATTACK TEAM

3-279. A JAAT is an engagement technique using a combination of attack reconnaissance aircraft and FW CAS aircraft operating together to locate and attack high priority targets and other targets of opportunity. The JAAT normally operates as a coordinated effort supported by FS, ADA, NSFS, ISR systems, EW systems, and ground maneuver forces against enemy forces (JP 3-09.3). The overall goal of JAAT planning is to apply constant, overwhelming firepower from multiple sources against the enemy. This goal must be tempered with the need to maintain proper coordination to avoid fratricide.

3-280. Attack reconnaissance helicopters normally perform as AMC during JAAT operations because they have the highest level of SA. To execute JAAT operations effectively, it is important to fully understand CAS and FA procedures as well as the capabilities and limitations of joint and combined assets. Appendix C provides detailed procedures for JAAT planning and execution.

ATTACK EMPLOYMENT METHODS

3-281. Timing is critical to the successful employment of the battalion. Employed too early, the battalion may have to disengage before mission completion because of low fuel. Employed too late, it may miss all or part of the targeted enemy unit, consequently failing to destroy the enemy force at the designated time and/or place.

3-282. The battalion commander employs the battalion after detailed coordination with the companies, combat support elements, and sustainment elements. The three methods of employment are continuous attack, phased attack, or maximum destruction.

CONTINUOUS ATTACK METHOD

3-283. To exert constant pressure on the enemy force, the battalion commander employs companies using the continuous attack method. This method ensures at least one ARC will be in the battle at all times. While one company is engaged in the battle, the other two companies prepare to relieve the engaged company by positioning at the HA or FARP, or maneuvering to the BP or ABF. The continuous attack method provides the commander with the most flexibility as well as the most efficient operation of the FARP.

PHASED ATTACK

3-284. To exert increased initial firepower of the battalion on the enemy force, the battalion commander employs one ARC to begin attacking the enemy and then quickly phases in the second ARC from a different BP or ABF. The third ARC is phased into the fight when either of the other companies is low on fuel or ammunition. The commander may choose to modify this method of employment, for example, one ARC may be employed to set the conditions for the other companies to exploit the attack. During the phased attack, it is important to minimize aircraft turnaround time at the FARP. Generally, due to the FARP limitations, the phased attack will eventually revert to the continuous attack method.

MAXIMUM DESTRUCTION

3-285. To exert maximum combat power on the enemy force, the battalion commander will employ the maximum destruction method. To overwhelm the enemy force with massed fires, the battalion will attack with all three companies simultaneously. While employing this method, it is important for the supported commander to understand the entire battalion may be out of the fight for 20 to 90 minutes at the completion of the initial attack. The time away from the fight will be dependent on the distance to the FARP and time required for refueling and rearming after the initial engagement.

SCOUT WEAPONS TEAM ATTACK PATTERNS

3-286. Attacks are characterized by movement and fires. At the SWT level, aircraft are normally employed using maneuvering flight techniques.

3-287. Maneuvering flight is used when the enemy situation, weapons delivery, or environmental conditions require a dynamic profile. It is used to maintain aircraft within proximity of the target, improve weapons accuracy, and minimize risk associated with static fire. Close combat maneuver (CCM) is executed based on METT-TC. Maneuvering flight communications require clear concise instructions using standardized terms as the most efficient method of communicating intent to the flight, such as “team one, mortar team, 11 o’clock, cloverleaf attack, left turns”.

3-288. Teams utilize attack patterns to maximize weapons effectiveness and minimize exposure to the threat. Factors affecting the selection of attack patterns include type/size of threat, ordnance to be fired, available attack lanes, weapons delivery technique, and location of friendly forces. Examples of attack patterns utilized by the SWT are racetrack pattern, L attack, and cloverleaf attacks. Company/platoon attacks can be accomplished utilizing the following methods with multiple teams. These attack patterns are modified to the operational environment's dynamic and are situational dependent.

3-289. The AMC modifies the timing of the attack run to provide for a simultaneous or continuous attack (figure 3-27, page 3-68). This is accomplished by adjusting the spacing between lead and wingman or the timing of the attack runs between multiple teams.

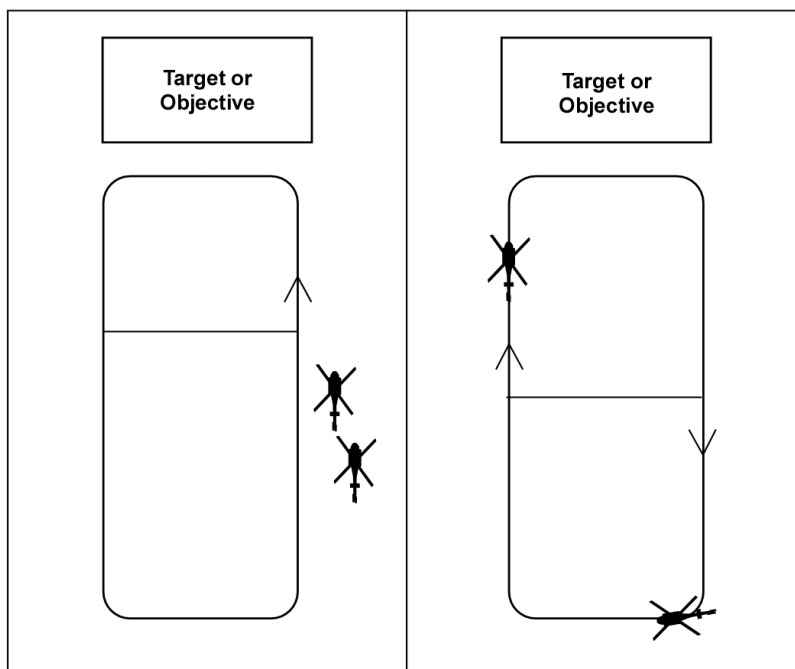

Figure 3-27. Example of simultaneous and continuous attacks

3-290. A simultaneous attack is executed from combat spread or combat cruise formation and is normally utilized when taking fire from the target area. Wingman's attack is timed to provide suppressive fire for lead's break-off of the target. Wingman may also fly roughly 45 degrees offset from lead on the side opposite lead's break. This permits suppression of the target area while lead is engaging and facilitates rapid disengagement from the attack run (figure 3-28, page 3-69). Wingman should maintain greater standoff during attack run because lead cannot provide coverage. Ideally, aircrews vary the direction of the attack after each turn.

3-291. A continuous attack separates team movement with only one team member inbound to the target area at a time. This technique is normally employed when the threat to the team is low or constant fire is desired on the target area. A continuous attack requires greater control and timing; lead should maintain an established airspeed in order for wingman to maintain proper spacing. Once this relationship is understood, modifications of the break line, speed, and delivery techniques may be made.

Racetrack Pattern

3-292. The racetrack pattern is the basic attack pattern from which all others are derived and is used to coordinate actions by each team member.

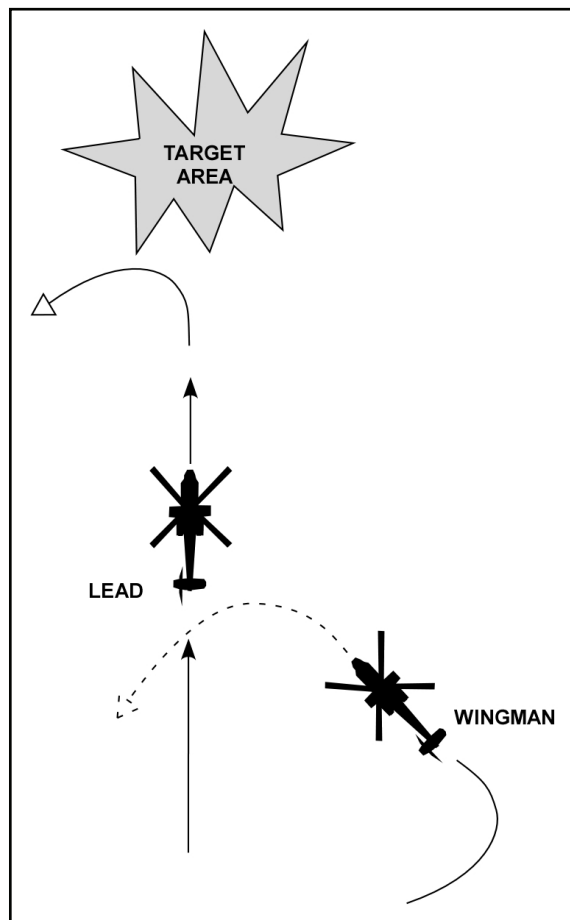

Figure 3-28. Example of a 45-degree simultaneous attack

3-293. The racetrack pattern is divided into three circuits based on weapon system capabilities and average attack speed. Teams adjust distance to targets as necessary based upon METT-TC. The three circuits are full, outer, and inner (figure 3-29, page 3-69).

- **Full circuit.** Provides maximum standoff and is primarily used for missile engagements.
- **Outer circuit.** Outside enemy crew-served weapons range and allows gun, rocket, and missile delivery; accuracy is reduced for gun and rocket engagements.
- **Inner circuit.** Outside enemy small arms range and enables gun and rocket engagements with best accuracy.

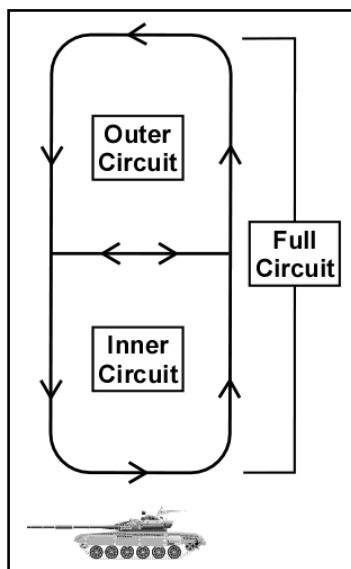

Figure 3-29. Racetrack pattern

Cloverleaf Attack Pattern

3-294. The cloverleaf pattern is a basic variant to the racetrack pattern and eliminates the predictability caused by multiple attack runs from the same direction. Number of leaves flown, engagement range, and timing are all flexible. When utilized with multiple teams the enemy is confronted with a high volume of fire from constantly changing directions. Care must be taken to avoid firing into other teams or overflying the target(s). Figure 3-30, provides an example of a cloverleaf attack pattern.

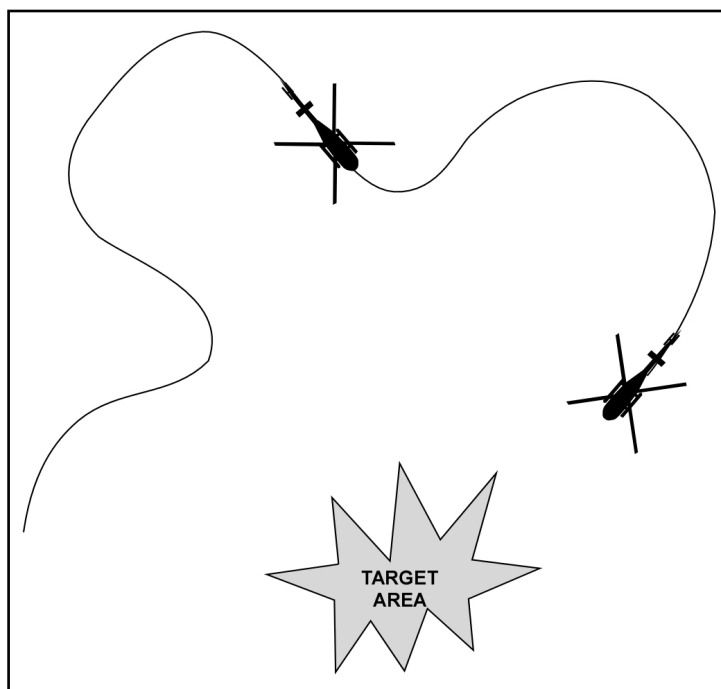

Figure 3-30. Example of a cloverleaf pattern

L-Attack Pattern

3-295. The L-attack pattern is used to attack a target requiring a large volume of fire for a short duration utilizing two SWTs. This pattern is capable of attacking linear targets masked by high terrain or obstacles on one side. Timing between teams is critical to provide simultaneous fire against the target. If a large volume of fire is not required both teams can establish racetrack patterns, and proper timing allows one helicopter at a time to provide neutralization fire. Figure 3-31, page 3-71 provides an example of an L-attack pattern.

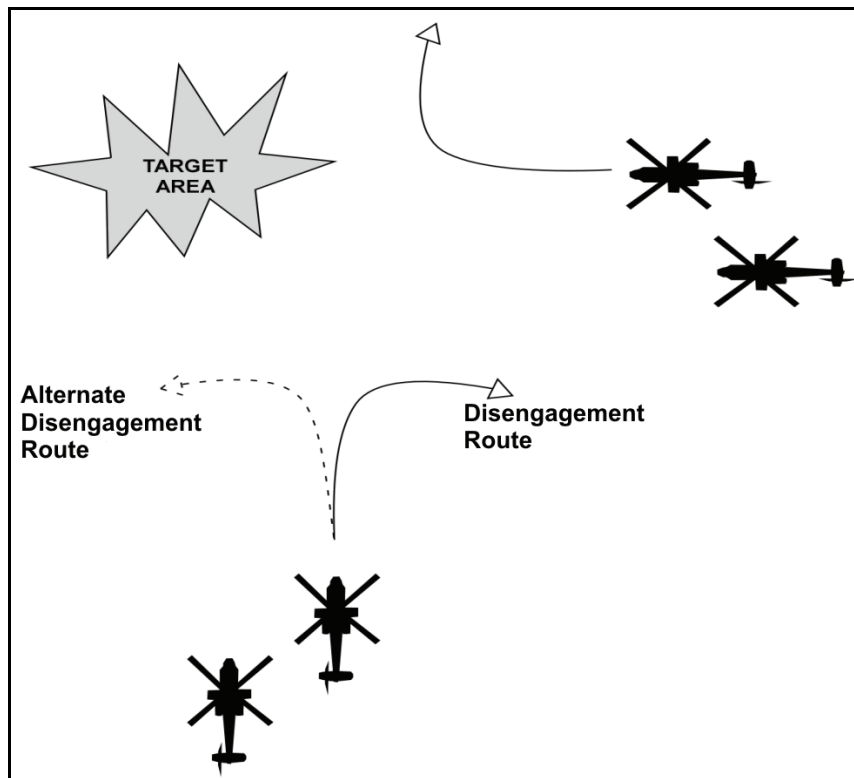

Figure 3-31. Example of an L-attack pattern

Static Attack

3-296. The static attack maintains all aircraft in an ABF/SBF and is utilized when the threat situation and environmental conditions allow aircraft to fire from a hover. The static attack provides for ease of C2 when conducting a platoon or company attack. Consideration must be given to ABF/SBF selection, including environmental conditions and the ability to maintain rear security. Figure 3-32 provides an example of a static attack.

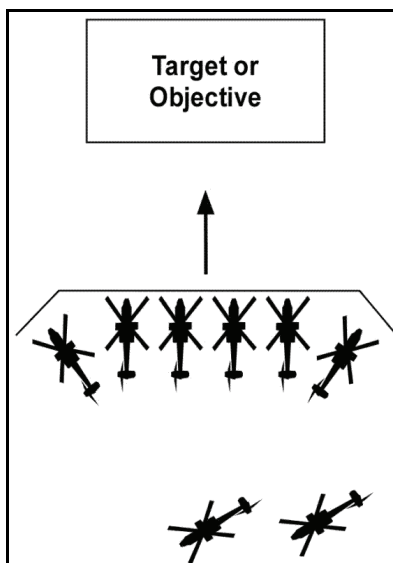

Figure 3-32. Example of a static attack pattern

WEAPONS DELIVERY TECHNIQUES

3-297. Teams can use different delivery techniques to engage the threat. These delivery techniques are divided into three types—hover fire, running fire, and diving fire.

Hover Fire

3-298. Hover fire is any engagement conducted below effective translational lift (ETL). It may be either stationary or moving. See FM 3-04.140 and ATMs for more information.

Running Fire

3-299. Running fire is an engagement from a moving helicopter above ETL. Forward airspeed adds stability to the helicopter and increases the delivery accuracy of weapon systems, particularly rockets. See FM 3-04.140 and ATMs for more information.

Diving Fire

3-300. Diving fire is a direct-fire engagement from a helicopter that is in a diving flight profile according to the aircraft ATM. The airspeed and altitude of the aircraft improve the accuracy of engagements, particularly for rockets. See FM 3-04.140 and ATMs for more information.

3-301. Aircrews may employ different attack methods to engage the enemy. These attack methods are low/level attack, bump attack, and high attack.

Low-level attack

3-302. Low-level attack is used when the aircraft is required to maintain near terrain or NOE when engaging a target; normally used during hover or running fire. An advantage of this technique is the aircrew's ability to maintain a lower profile that is masked by background terrain or vegetation making it difficult for the enemy to judge closure. A disadvantage is the aircrew cannot engage the target at maximum range of the weapons system due to targeting hindered by a level viewing angle. Additional disadvantages include limited LOS, decreased accuracy (both initial and subsequent rounds), and wider dispersion resulting in decreased weapons effect and increased chances for fratricide and collateral damage. Figure 3-33 illustrates the low-level attack technique.

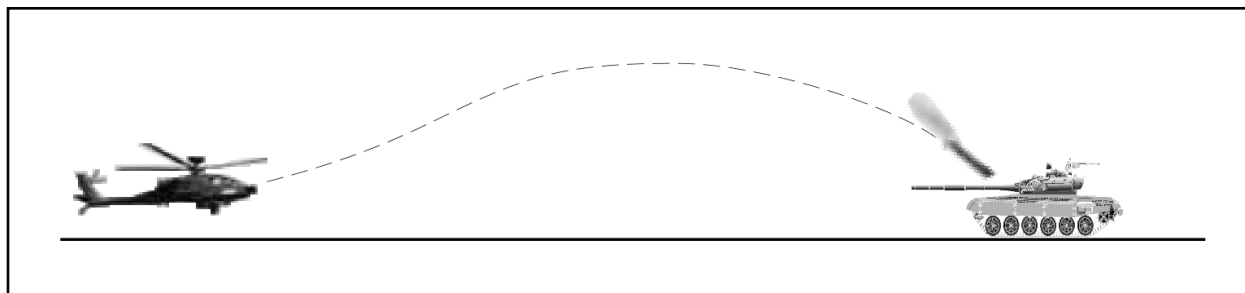

Figure 3-33. Low-level attack

Bump attack

3-303. The bump attack is used to take advantage of masking terrain while increasing the angle of attack; normally used during running fire, transitioning to diving fire. Each aircrew bumps up prior to or during weapons engagement and then returns to terrain flight altitude.

3-304. Advantages of this technique are the aircrew's increased ability for longer distance engagements, dispersion of weapon's effects is decreased, lookdown angle is increased making target identification easier, and aircraft momentum is maintained for maneuver. Disadvantages include silhouetting of aircraft on horizon during bump, and excessive bump reduces airspeed and energy for maneuver. Figure 3-34 illustrates the bump attack.

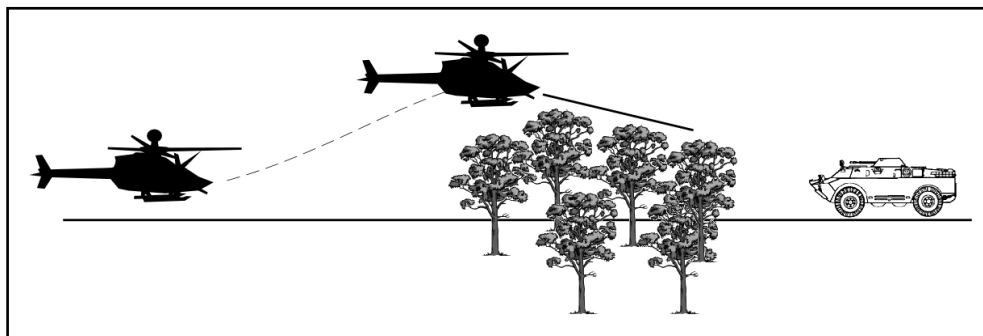

Figure 3-34. Bump attack

High attack

3-305. High attack is used during diving fire when aircraft are required to maintain higher altitudes, normally greater than 1,000 feet. This technique is especially useful for following targets through urban areas and allows for remote engagements. Other advantages include aircraft remain above accurate small arms fire while retaining energy for maneuver, allows for greater target identification within urban areas or restrictive terrain, and minimizes weapon's effects dispersion and laser error. A disadvantage is the higher altitudes enable greater effectiveness of threat IR and RF missiles. Figure 3-35 illustrates high attack.

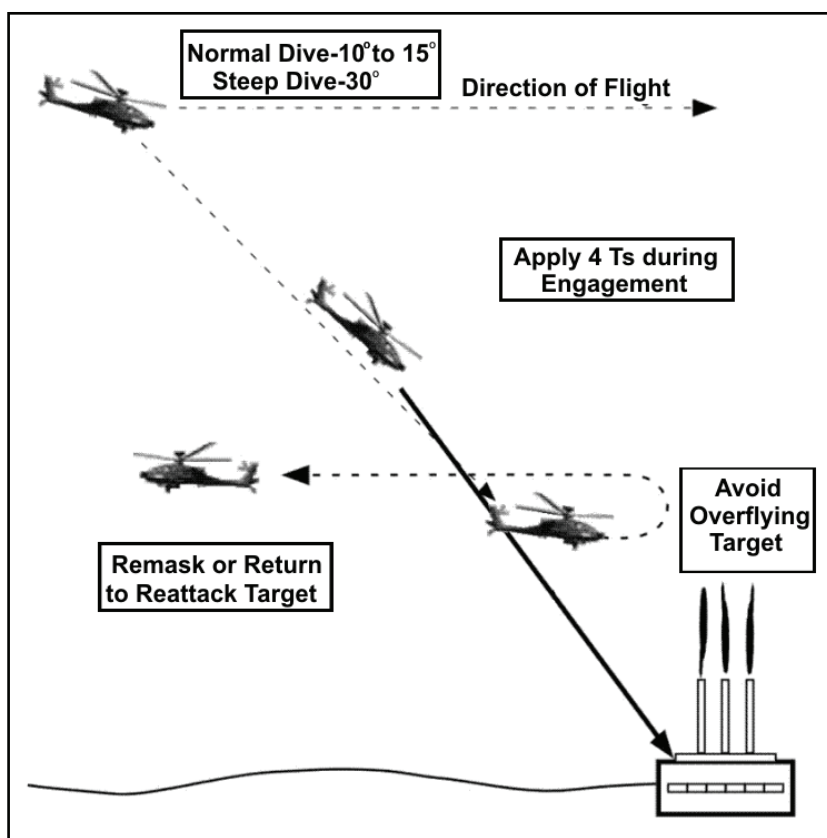

Figure 3-35. High attack

3-306. Combinations of the weapons delivery techniques listed may be performed. Variations may be required, but the basics remain the same. Careful consideration must be given to power available, station time, continuous attack or team attack, and ordnance to be delivered. Direction of attack should be based on the same factors used in firing position selection.

ENGAGEMENT AREA DEVELOPMENT

3-307. The battalion or TF is responsible for planning EAs, whereas the company conducts direct fire planning. The EA development process is characterized by eight steps.

- Step 1. Intelligence preparation of the battlefield.
- Step 2. Select the ground for the attack.
- Step 3. Integrate the EA.
- Step 4. Plan the direct-fire fight.
- Step 5. Fire control.
- Step 6. Review the plan.
- Step 7. Rehearse the plan.
- Step 8. Execute the plan.

STEP 1—INTELLIGENCE PREPARATION OF THE BATTLEFIELD

3-308. Upon receipt of the mission, the battalion S-2 begins the IPB process (see FM 34-130 for more information on the IPB process). This initial process includes the following:

- Battlefield area evaluation.
- Terrain analysis.
- Weather analysis.
- Enemy evaluation.
- Enemy integration.

3-309. This process will provide the commander with possible enemy COAs. The S-2 should list these courses (most probable through most dangerous) in descending probability and select NAIs or points along enemy mobility corridors that confirm or deny a particular enemy COA. Enemy activity or lack of activity in a named area of interest (NAI) helps the S-2 refine his estimate of the enemy COA.

3-310. The S-2, in coordination with the S-3, identifies NAIs or points along the enemy's mobility corridors where interdiction of enemy forces by friendly force maneuver, fires, or jamming will deprive the enemy of a particular capability.

3-311. Additional points, DPs, may be selected based on time and space where critical events are expected to occur which will necessitate a decision. For example, the commander may designate the enemy's crossing of DP1 as the event requiring a decision on whether or not to launch the attack.

3-312. The IPB process drives the formulation of plans. At a minimum, the S-2 should answer the following questions before the OPORD is presented to the companies:

- Where is the enemy currently located?
- Where is the enemy going?
- Where can we best engage the enemy?
- When will the enemy be there?
- What weapons systems do the enemy have that can affect our unit?

STEP 2—SELECT THE GROUND FOR THE ATTACK

3-313. Once the S-2 identifies the enemy's most probable COA, the battalion commander picks the point on the ground where the enemy will be attacked. This is the point where the commander intends to mass combat power. Figure 3-36 illustrates steps one and two.

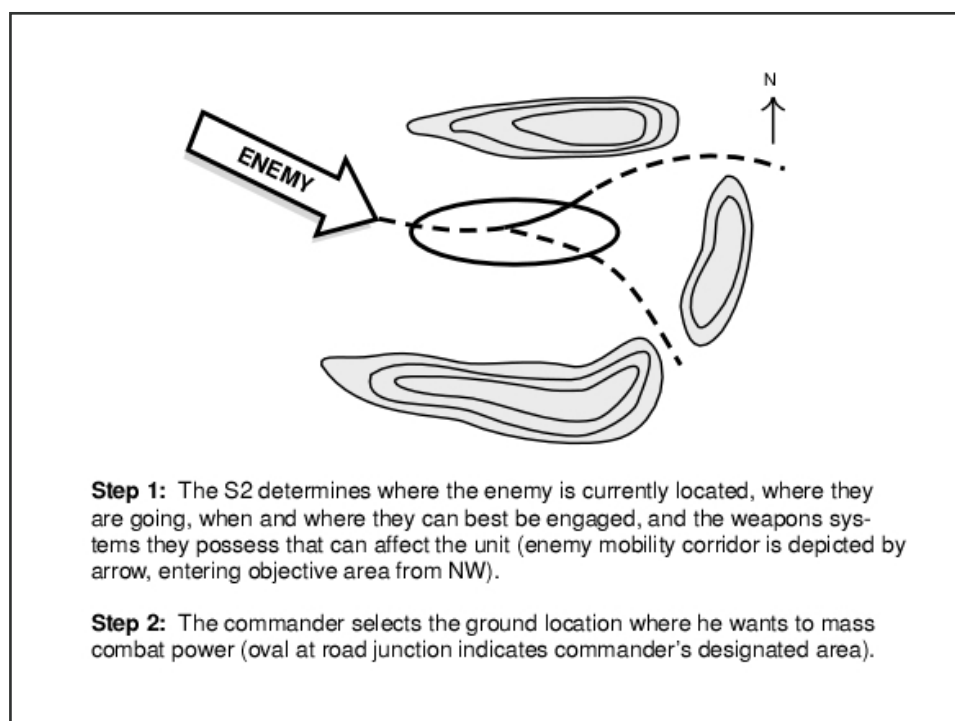

Figure 3-36. Engagement area development steps one and two

- 3-314. During this step, the commander issues or reconfirms the nine elements of commander's guidance:
- **Guidance on enemy COA.** This element informs the staff which actions to focus on and which actions to dismiss.
 - **Restated mission.** This element is the approved mission by the commander including all specified and implied tasks.
 - **Commander's intent.** This element is the purpose, method, and endstate of the mission. It clearly states success criteria.
 - **Concept of the operation.** This element features where, when, and how the commander is expecting to accomplish the mission.
 - **Deception objective.** This element is the deception (if applicable) tied into the higher commander's plan. This may include "deception SEAD".
 - **Priorities.** These elements are the commander's combat support and sustainment priorities. The staff focuses on the fueling, fixing, and rearming functions for the fight.
 - **Time plan.** This element focuses the staff on the amount of time available to the battalion for EA planning, as well as the time available to the companies to direct fire planning.
 - **Type of order to issue.** This element gives the staff guidance on the type of order to issue to the companies so they can complete their plan.
 - **Type of rehearsal to conduct.** This element is critical prior to mission execution.

STEP 3—INTEGRATE THE ENGAGEMENT AREA

3-315. The EA is an area where the friendly force commander intends to trap and destroy an enemy force with the massed fires of all available weapons. EAs are control measures that focus fires and distribute those fires throughout the target. This step is depicted in three parts with figures 3-37 and 3-38, page 3-74, and Figure 3-39, page 3-75.

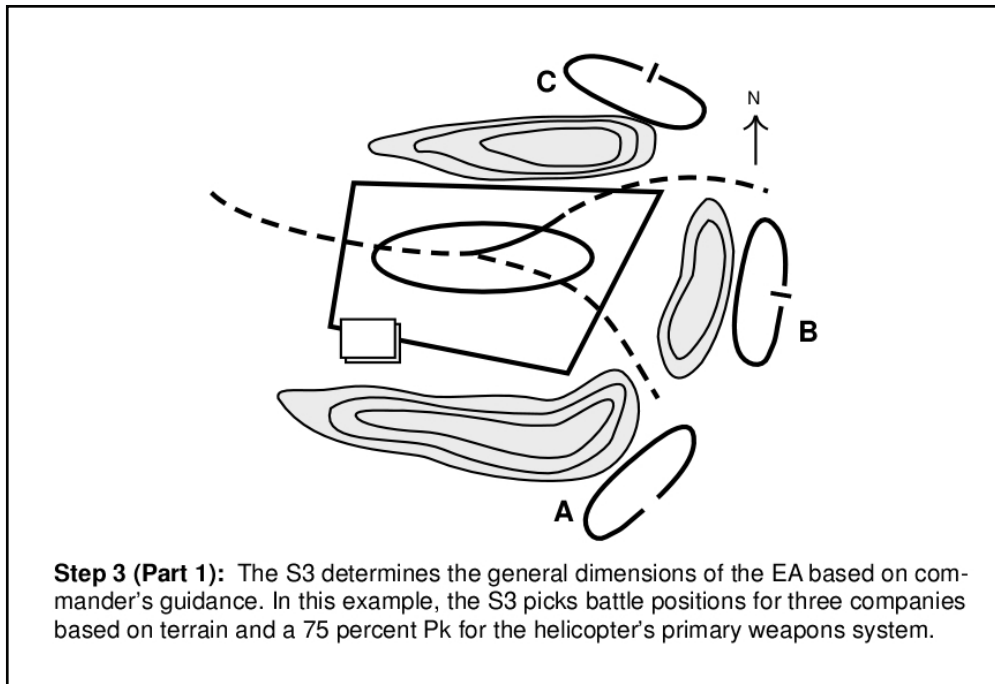

Figure 3-37. Engagement area development step three (part 1)

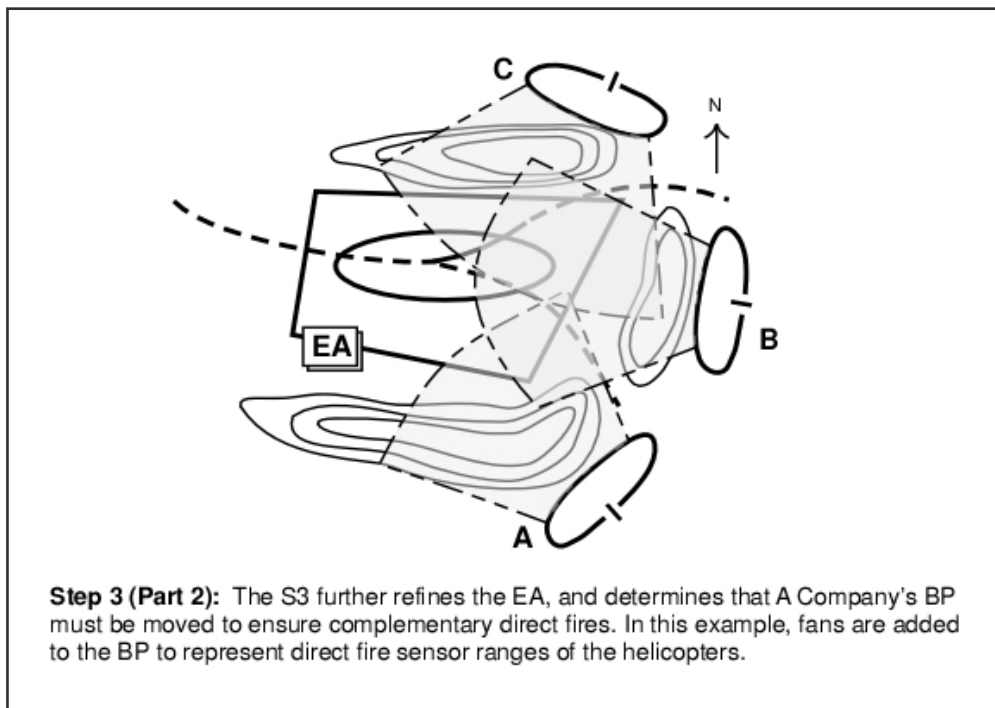

Figure 3-38. Engagement area development step three (part 2)

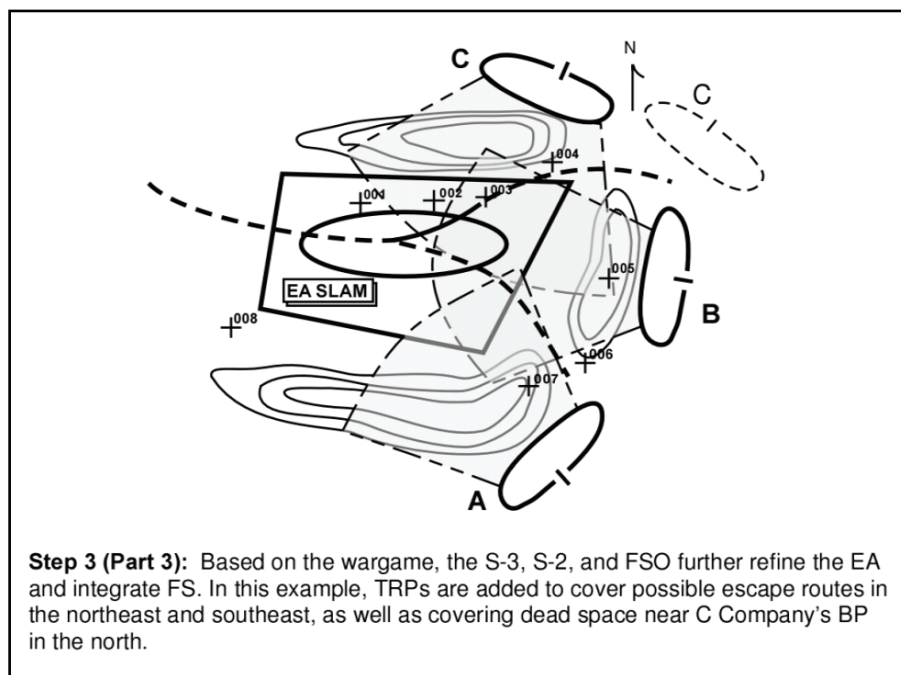

Figure 3-39. Engagement area development step three (part 3)

3-316. The staff identifies preliminary BPs for the EA based on the commander's guidance, terrain, and sensor range producing an adequate probability of kill (Pk) for the helicopter's primary precision guided weapon. Prior to integration of direct fire, the following points must be considered:

- Enemy avenues of approach.
- Enemy rate of advance.
- Key terrain that gives the advantage for specific avenues of approach.
- What formation the enemy will use, and at what point will they likely change formation?
- Expected range to engagement.
- Maximum effective range of friendly weapons systems (direct and indirect).
- When the enemy will begin counter-engagements?
- Maximum effective range of enemy weapons systems (direct and indirect).
- Where is the dead space in the EA, and how it will be covered?

3-317. Based on the outcome of the EA wargame, the FSO, S-3, and S-2 will integrate the use of artillery, CAS, UAS, and mortars to shape the operational environment for the direct fire fight. This integration of fires is based on the commander's intent for fires on the objective. The following questions must be answered prior to mission execution:

- What is the endstate of the direct fire plan?
- How much artillery, CAS, and mortars will be available for employment in the EA?
- Who will initiate the fires?
- How will the friendly unit shift fires?
- Who will clear fires once the direct fire fight starts?

3-318. An obstructed EA complicates actions on the objective. While the EA may be perfectly clear when the first rounds are fired, burning vehicles, munitions impacts, and/or environmental conditions can quickly obscure the view from the planned BPs. Consequently, it is important to consider the following during planning:

- **Prevailing/forecast winds.** During the planning process, forecasted winds in the EA that will obscure either the BP or the EA must be considered for engagement priorities and techniques. Smoke and/or dust may cause laser ranging and designation to be unreliable.
- **Nature of the target.** If the targets to be engaged have the propensity to burn after being hit, thought must be given to the engagement priorities. As an example, a brightly burning light skinned vehicle near a BP may obscure heavier, more dangerous vehicles in the EA.
- **Number of targets.** If the plan calls for destroying or killing a large number of targets with direct fire, consider engaging targets across the depth of the formation simultaneously. This technique will disorganize the formation quickly and allow for engagement throughout the EA with rockets and indirect fire.
- **Terrain.** It is important to cover dead space with indirect fires or rockets. Units should also be aware smoke tends to cling in the low ground during hours of darkness. This may allow enemy vehicles to move undetected, making it difficult, if not impossible, to engage those vehicles with laser-guided weapons.
- **Planned obscurants.** FLIR sights may be required during daylight operations for target engagement to see through obscurants. Aircrews must complete boresights and operational checks of all sights, whether or not the crew expects to use them during the actual mission.
- **Effective engagement.** Planners understand for different missiles, cloud ceilings below certain elevations will inhibit effective engagement. These minimums cloud cover conditions require careful planning to ensure the use of the correct missile type and programmed trajectory for predominant weather in the contingency area. Because of sensor and laser limitations, missile engagements beyond 6 kilometers require a closer remote designator to permit a higher lock-on-after-launch Pk.

3-319. While remote designation must occur for a minimum length of time, continuous target designation is undesirable due to backscatter and other potential countermeasure capabilities. Fog, haze, snow, and dust/blowing sand may increase backscatter causing an out-of-constraint condition. Remote designation from too great a distance may result in beam divergence and too wide of a spot on target.

3-320. Once the staff planning is complete, the commander should be able to answer yes to each question in the EA checklist (table 3-7).

Table 3-7. Engagement area checklist

<i>Does The Plan</i>	Yes	No
Concentrate on long range targets?		
Engage targets with high Pk?		
Minimize risk?		
Destroy most dangerous targets first?		
Maximize each weapon system?		

STEP 4—PLAN THE DIRECT-FIRE FIGHT

3-321. The plan is generated by battalion planners with input from company officers encouraged in the process.

3-322. The battalion commander assembles his aircrews and planners to obtain a final view of the battalion plan. Using the overlay and any additional information provided by the staff, the commander ensures that crews can identify the TRPs, obstacles, avenues of approach, prominent terrain features, and dead space present in the EA.

3-323. Using TRPs, terrain features, or manmade obstacles, the commander sectors the EA by ensuring each crew has a well-defined and understood responsibility. An individual helicopter sector should be wide enough to allow some overlap with adjacent helicopters, but narrow enough to prevent overkill. This action will reduce the scanning required by the crew and minimize the likelihood for overkill; it also ensures the entire EA or sector is effectively covered by direct fire.

3-324. The company commander establishes control measures for the direct-fire fight and other actions time or space dependent. Most commonly, the battalion commander will establish a trigger line for the direct firefight; however, a company commander initiates it. Further, on-scene visualization will help the commander decide which fire distribution method to employ. Fire distribution methods include closest TRPs, quadrants, fire patterns, target array, and sectors. Figure 3-40 addresses fire distribution techniques.

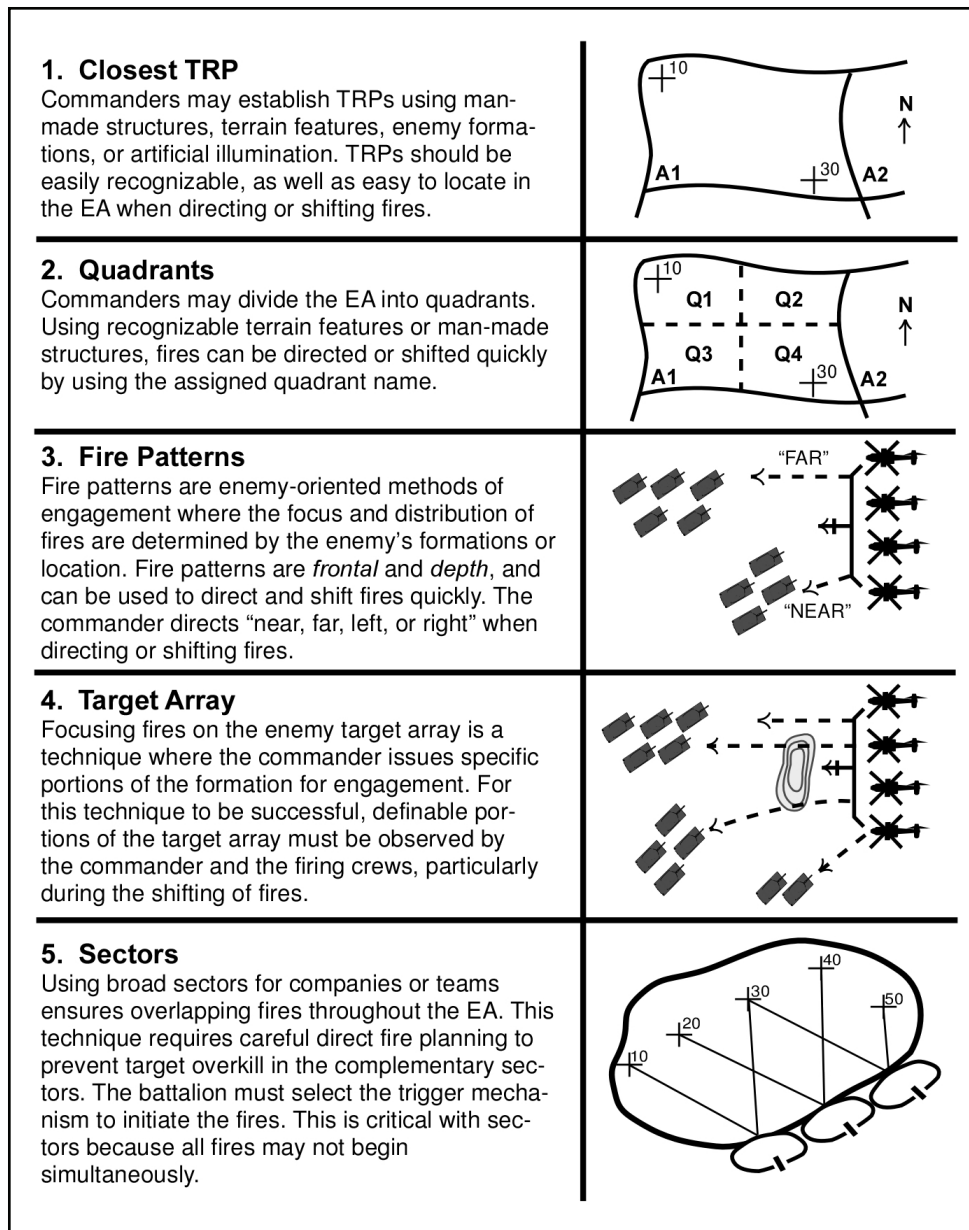

Figure 3-40. Techniques of fire distribution

3-325. The battalion commander assigns sectors of fire to each company, providing full mutual support between helicopters and integrating FS. This planning includes the following:

- The battalion commander must plan for rear flank security in the BPs. One to two helicopters may be designated for security during the engagement.
- The direct fire plan assigns responsibilities for long range direct fires. The commander also defines areas designated by engagement with rockets and cannon, and how those fires are

initiated. During company level planning, “range fans” or arcs are drawn on the sector sketch to represent weapons ranges and time of employment. This type of planning helps crews select the proper weapon for the anticipated target at certain ranges.

- Crews must be ready to repel dismounted infantry and other vehicles in the BP; and they must know positions of friendly elements in the area.

3-326. The battalion commander ensures supplementary BPs integrate the same level of planning and FS as the primary positions. Each crew must also have a complete understanding of the criteria for movement from the primary to the supplemental BP.

3-327. Lastly, the commander will devise a method to determine if and when the mission has been accomplished. The commander’s intent describes the destruction criteria and endstate, and the commander will not conclude the mission until those criteria are met.

3-328. Commanders mass the effects of onboard weapons in the EA. They also use complementary systems, such as artillery, CAS, mortars, and other available systems as combat multipliers to overwhelm the enemy at the decisive place and time.

3-329. Piecemeal fires limit the attack reconnaissance unit's capability. There must always be a primary and alternate method of executing the fires.

3-330. Fires must be focused on the critical point at the critical time. The three key elements to successful massing of direct fires against any target are—

- Clearly communicating instructions to fire elements.
- Using recognizable control measures, whether friendly, enemy, or terrain based.
- Detailed training, SOPs, and planning for engagement.

3-331. Principles for distributing fires are listed below:

- Critical targets are engaged first.
- Engagements are conducted laterally and in-depth simultaneously.
- Designation of which weapons will engage which targets is decided during planning.
- Designation of which aircrew will engage which targets is decided during planning.

3-332. Fires must be controlled and shifted to react to enemy actions. Shifting of fires should be planned and rehearsed. When conducting hasty operations, fire distribution for the ARC must be kept simple. To maintain simplicity, adhere to the following general principal of fire distribution:

- Left shoots left, right shoots right, and rear and center shoots center zone.
- Priority fire zones (PFZs) are the primary method of distribution.
 - PFZs are established by the company commander or the first aircraft with eyes on the sector.
 - PFZs are oriented with the movement of the enemy in a logical manner.
 - PFZs are based on mission, terrain, and number of aircraft.
- Teams are assigned a specific zone and utilize the general principle of fire distribution in each.

3-333. All crews must understand the fire plan. This includes a solid understanding of the mission and the commander’s intent. The fire plan rehearsal allows every crewmember to understand it and point out any shortcoming in the plan prior to execution. Step 4 is depicted in figures 3-41 and 3-42, page 3-81.

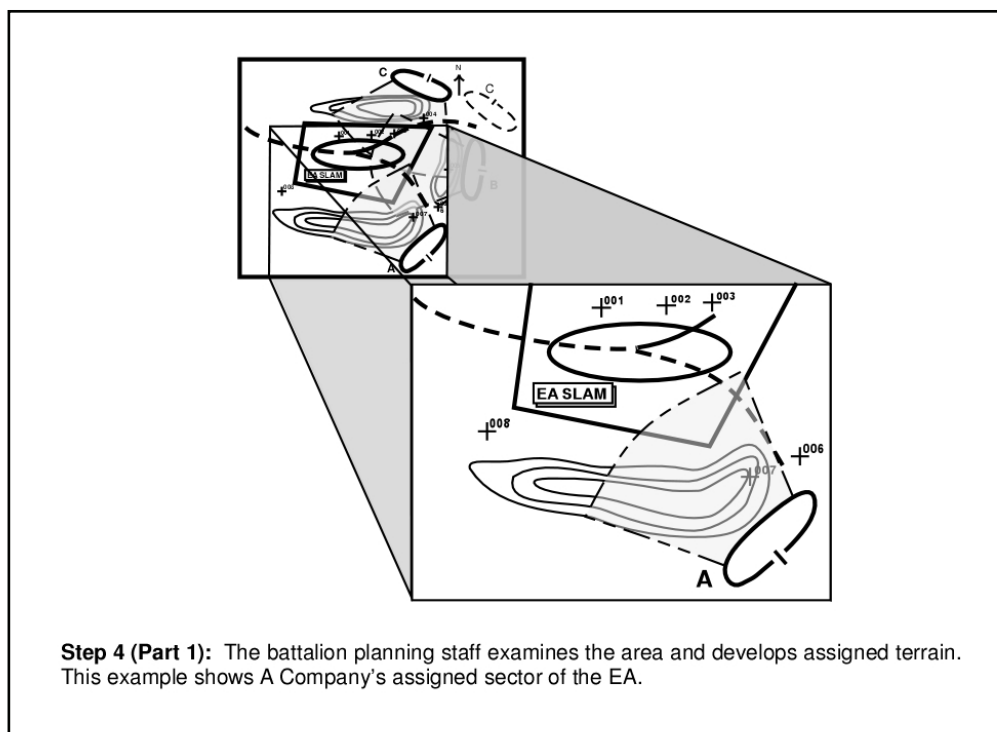

Figure 3-41. Engagement area development step four (part 1)

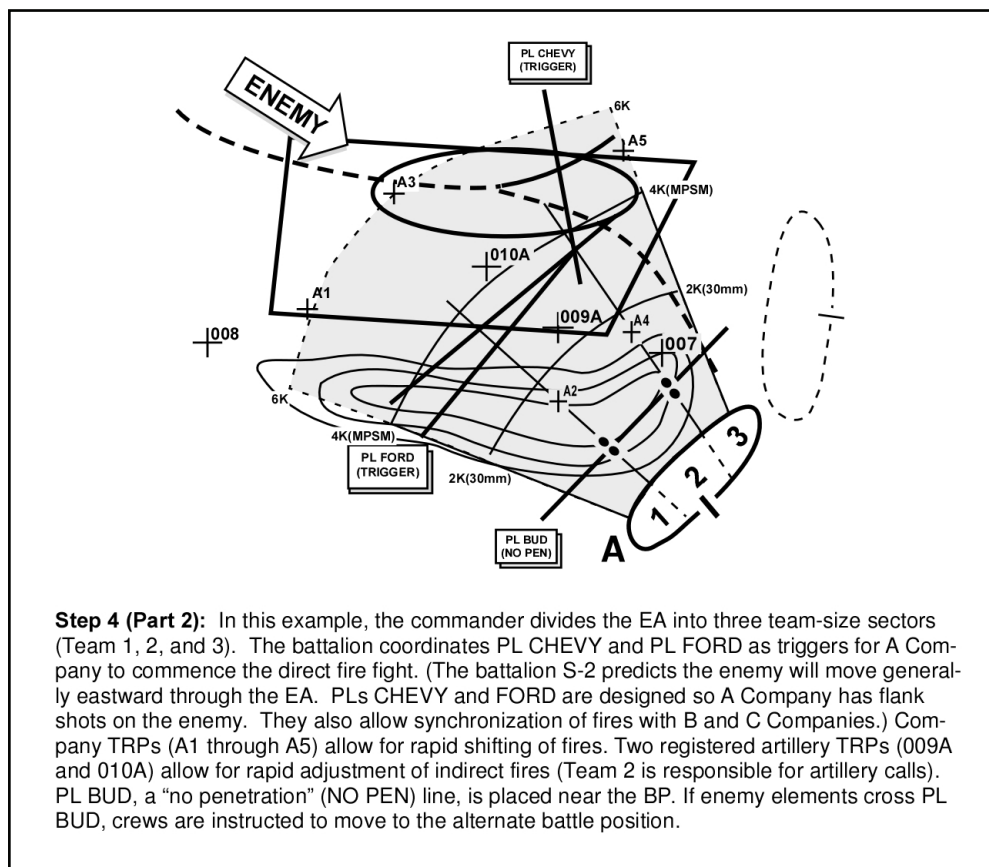

Figure 3-42. Engagement area development step four (part 2)

STEP 5—FIRE CONTROL

3-334. The company commander or AMC is in control of fires. The commander uses two processes to control fires—fire planning using triggers and fire commands using communication. The commander decides how to control fires based on the situation and time available to plan and prepare.

3-335. A standard unit fire command may include as many as five elements in the following order:

- Alert.
- Weapon or ammunition.
- Target description.
- Orientation.
- Execution.

3-336. In a deliberate attack, with prior planning time available, the commander can initiate the fight with a trigger. A trigger is an event, such as enemy crossing a terrain feature, beginning the direct fire plan. Further fire commands may be required, but the object of the planning phase is to anticipate events and coordinate fires before the fight starts.

3-337. In a meeting engagement or movement to contact, when planning time is limited, the commander initiates fires with a standardized abbreviated fire command. For example:

- Alert—"Blue 14, this is Blue 6."
- Description—"Three tanks and multiple armored personnel carriers."

- Orientation—"Vicinity TRDP 016."
- Execution—"At my command, fire."

3-338. A coordinated fire plan requires minimum radio traffic over the net during execution. Trigger points, priority of engagements, and targets are established in advance. This assures direct fires are placed on the enemy even if communications are interrupted or unit leadership is disabled.

3-339. Standardized fire commands are established in the unit SOP and practiced by the chain of command. Using a standard format for a fire command ensures all essential information and control measures are given quickly and accurately. Even under the most adverse conditions, this format causes positive reaction by the unit. Brevity and clarity are essential. Abbreviated methods for identifying target locations are encouraged, but they must be familiar and understandable.

3-340. Coordinating instructions for additional information may be given by the commander to individual aircraft; however, this information is not part of the fire command. When a crew renders a contact or SPOTREP, and it is reasonable to believe all other aircraft in the company received it, the commander issues only the elements needed to complete fire command.

3-341. The nature of the target dictates the type of fire pattern used. During premission planning and/or rehearsal, each aircrew must completely understand how the threat will look within the EA, and what effects the engagement will have on that threat. Whether engaging massed armor formations on the move or fixed targets, the way each crew executes fires must be solidly understood.

3-342. The two basic fire patterns are frontal and depth. These two fire patterns cover most situations and promote rapid, effective fire distribution. Regardless of which fire pattern is employed, the objective is to engage far and flank targets first and then shift fires to near and center targets. Enemy targets should be engaged by most dangerous to least dangerous within the assigned sector. The commander may choose to modify this practice should a designated priority target come into view.

- **Frontal pattern.** The frontal pattern is used when all engaging helicopters have unobstructed fields of fire to their front. Flank helicopters engage targets to the front and then shift their fires toward the center as the targets are destroyed. Frontal engagement calls for crews to engage targets near to far and flank to center.
- **Depth fire pattern.** The depth fire pattern is used when targets are exposed in depth. An entire company may be required to fire on a column formation in depth, or individual helicopters engaging in their sector may have to fire in depth. Should the entire company be engaging the threat simultaneously, it may be possible for each helicopter to fire in depth on a portion of the enemy formation. In this type of situation the far left helicopter engages the far left target and shifts fire toward the center as targets are destroyed. The left center helicopter engages the closest (front) targets and shifts to the rear as targets are destroyed; the right center helicopter engages the center targets and shifts fires to the front as targets are destroyed and the far right helicopter engages targets on the far right and shifts fires to the center as targets are destroyed. The commander always has the option to employ something other than simultaneous fire and will specify that order in the alert element of the fire command.

Principles of Fire Control

3-343. More than any other factor, it is important to avoid overkill as it increases a weapon's Pk. In a target-rich environment, a unit may expend its ammunition and still not meet defeat criteria stated in the commander's intent.

3-344. Each weapon system must be used effectively. A detailed IPB will help the commander decide which target should be serviced by which weapon. For example, if all antitank guided missiles (ATGMs) have been expended against trucks and a tank battalion enters the EA, the ARC may not be able to accomplish the mission.

3-345. The most dangerous targets are to be destroyed first. Commanders ensure engagement priorities are fully understood by each crew member. The targets posing the greatest threat to force must be destroyed first to expose the more lucrative targets.

3-346. Units must concentrate on long-range targets. This principle will provide standoff and allow the commander time and maneuver space should the enemy decide to maneuver their forces toward the friendly force. The commander must understand the limitations of air crews, weapons, and sensors to determine at what ranges targets can be engaged while maintaining a high Pk. Additionally, environmental conditions may minimize effectiveness of long-range weapons due to the sensor's inability to identify the target because of fog, dust, or other environmental conditions.

3-347. Units prudently to take the best shot and expose only those aircraft engaging the enemy target. This principle will increase the Pk, while protecting the aircraft as long as possible. High Pk will confuse the enemy in regard to friendly force size and disposition.

3-348. Prior to assignment of fire patterns, the commander remains focused on the effects fires have had based on the desired outcome of the pending engagement. The goal should be ensuring the enemy remains in the EA until its force strength has been degraded to the level that is outlined in the commander's intent. By ensuring that the EA is effectively covered, the enemy will not be able to leave the area prior to termination of engagement.

3-349. Termination of engagement occurs in one of three following ways:

- The commander announces to cease fire.
- All targets are destroyed.
- All ammunition is expended.

Step 6—Review the Plan

3-350. To ensure detailed and complete planning, the staff and aircrews should be able to answer the following questions:

- What is the mission and endstate?
- Where is the enemy, and how will it enter the AO? What does the IPB say?
- Where are the enemy's key weapons? What are its capabilities?
- Where will the enemy be killed?
- Where will the enemy be engaged? Are the ranges realistic? Are the positions too restrictive?
- What is the role of complimentary systems and joint fires?
- What is the appropriate weapons load?
- What is the target priority?
- How will fires be initiated?
- What is the fire command? Which weapon systems will be fired first?
- What is the desired effect of fires from each system?
- How will fires be distributed?
- How will fires be massed? Does the unit have the required volume?
- Can the unit complete the job with time and assets provided in the assigned space?
- Where will C2 be? Can the commander see the battlefield?
- How/when does the unit shift fires? What is the "key event" to cause shifting of fires?
- How does the unit deal with enemy reactions to fires?
- What is the plan for flank and rear area security in the BP?
- Does the plan follow the principles of direct fire?

Step 7—Rehearse the Plan

3-351. Once the battalion commander is comfortable with the concept of the operation, fire distribution plan, and crew's understanding of the plan, all crews are assembled for a rehearsal.

3-352. Rehearsals start with actions on the objective area in case the rehearsal must be cut short. Time permitting; the rehearsal can then revert to the AA with communication checks and progresses through

lineup for take-off, air routes, occupying BPs at the objective area, and egress. Critical questions needing answered are—

- Who is responsible for initiating the secure communications check?
- Who will call for indirect fires?
- Who will be assigned BP security?
- How will SPOTREPs be collected and sent?
- How will the fires be initiated?
- Who is responsible for coordinating and communicating with United States Air Force JAAT?
- Who will coordinate and communicate with the ground force commander?
- What radio calls are required during conduct of the operation?
- What are the actions on contact?
- What are the contingency plans?
- What is the success criterion and what will determine if that criterion has been met?

3-353. Rehearsing the plan is an ideal opportunity for identification of possible conflicts and resolving them prior to execution. However, the primary purpose of the rehearsal is ensuring all crews know and understand the commander's intent and how it will be executed.

Step 8—Execute the Plan

3-354. After the decision has been made to initiate mission execution, units fly their assigned routes to their BPs, ABFs, or SBFs. En route crews will engage or bypass unanticipated threats in accordance with predetermined criteria. Possible engagement priorities may include—

- Threat to self.
- Threat to unit.
- Threat to friendly forces.
- Target priorities.

3-355. Once established in BPs, crews prepare for engagement. They must expect the enemy to employ active and passive AD measures unless reliable intelligence predicts otherwise.

3-356. When targets have been located and positively identified, a contact (SPOTREP) is sent to the commander. Ideally, the commander will be able to issue a fire command with "at my command" as the control element. At this point, individual crews will—

- Observe and select the targets based on the preplanned fire pattern(s).
- Acquire and range the first target.
- Hold for the commander's order to "fire".

3-357. Simultaneously, while crews fix their targets, the commander coordinates for indirect fires to engage enemy forces within the EA.

3-358. Execution begins at receipt of the fire command or a predetermined trigger point. As the fight progresses, aircrews adjust fires and switch targets according to the fire command or SOP. As an example, the target priorities may be—

- Most dangerous targets (ADA Systems).
- Tanks and/or ATGMs.
- C2 assets.
- Specialty vehicles.
- Artillery.
- Least dangerous targets.

3-359. The amount of time a helicopter can safely remain unmasked will depend on the enemy. Should enemy AD or tanks be in overwatch, or if the target is stationary, the aircrew should not make more than

two engagements from the same firing position. When not engaging targets, aircrews should remask and reposition to provide observation or assistance to other crews, as practical.

3-360. After the commander has issued a cease fire and engagement is complete, he completes a BDA and consolidates fuel, ammunition (cannon), rocket, and munitions reports of each crew. With that, a determination is made to continue the attack or the helicopters break station. The commander's timely assessment of the engagement forwarded to battalion headquarters is critical for possible follow-on planning or action.

ENGAGEMENT AREA DEVELOPMENT/DIRECT FIRE SUMMARY

3-361. Basic fundamentals are summarized below.

- Battalions plan EAs. Companies conduct direct fire planning.
- Standardized fire commands must be established by unit SOP and practiced by all leaders and crews.
- All crews must understand basic fire patterns and each crew's responsibility for target engagement by SOP.
- A well-planned engagement requires minimum radio traffic during execution; trigger points, priority of engagements, and targets are established in advance.
- Leaders must plan engagements within the "useable range" of the sensors, not merely "maximum range".
- All crewmembers must understand the mission and commander's intent.
- Conduct joint fire operations.
- Destroy enemy C2 elements, AD systems, long-range SSMs and artillery, and reinforcing ground forces.

HOLDING AREA OPERATIONS

3-362. The HA is the last covered and concealed position prior to the objective that is occupied for short periods of time. It is normally located approximately 2 to 5 kilometers behind the BP, ABF, or FLOT. However, in the common operating environment, the HA may be located in a forward operating base (FOB) based on METT-TC. Occupation of a HA allows for final reconnaissance and coordination of assets by the commander. If the HA is occupied for more than a few minutes, aircraft move to an alternate HA or return to the FAA. HA occupation is based on environmental conditions and may be modified by teams as they enter the HA. Units that occupy HAs ensure—

- Aircraft remain at NOE altitudes at or within the vicinity of the HA.
- Aircraft maintain operating revolutions per minute (aircraft may hover or land, but will not be shut down).
- Crews maintain radio listening silence (one crew member dismounts for face-to-face coordination with the commander).
- Separate HAs are established for each company.
- Aircraft establish positions that provide 360-degree security (figure 3-43).
- The 12 o'clock position is oriented towards the enemy.
- HA is terrain masked and free of sources of rotor wash signature.
- Aircraft are dispersed and maintain team integrity while ensuring intervisibility for security.

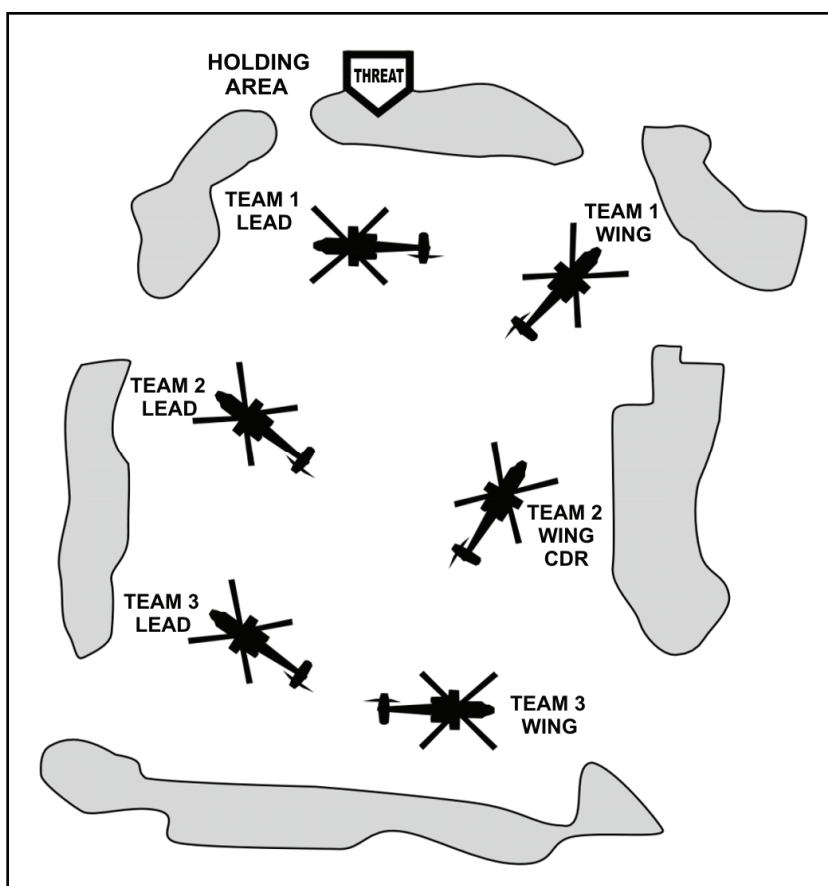

Figure 3-43. Holding area occupation

Note: Teams 4 and 5 land in a similar fashion as team 3 providing 360-degree security.

ATTACK BY FIRE/BATTLE POSITION OPERATIONS

3-363. ABF and BP operations are key components of the overall success of the battalion/company in combat. Efficient concentration of combat power at the objective is gained through disciplined operations, trained movements, standardized procedures, disciplined fire distribution, and exacting mission rehearsals.

ATTACK BY FIRE/BATTLE POSITION OCCUPATION

3-364. Occupation of the ABF and BP are very similar. Occupation of the ABF, while deliberate, is normally characterized by greater freedom of movement than the occupation of the BP.

3-365. Once the commander issues the order to move to the ABF/BP, the lead team clears the attack route, maneuver area, and ABF/BP of immediate threats. Once the ABF/BP is cleared of threats, the teams move into position (see section VI, attack operations). The commander may position teams in a standard or nonstandard set.

Standard Set

3-366. Teams key off the lead team and begin occupying firing positions as briefed. This set is used unless the commander selects a nonstandard set. Figure 3-44 illustrates an example of a standard set.

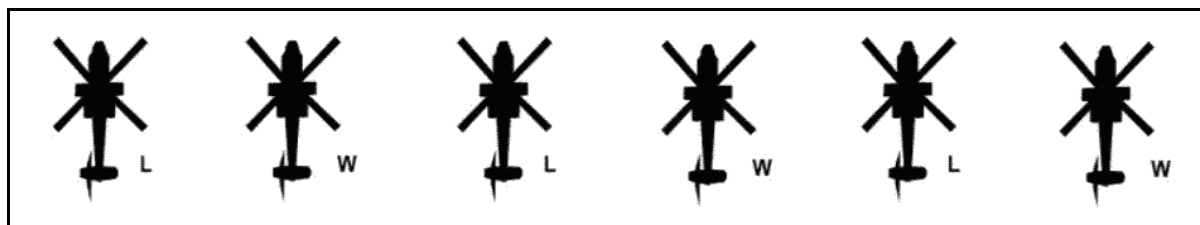

Figure 3-44. Example of a standard set

Nonstandard Set

3-367. Teams key off the lead team and begin occupying firing positions as briefed. Figure 3-45 illustrates an example of a nonstandard set.

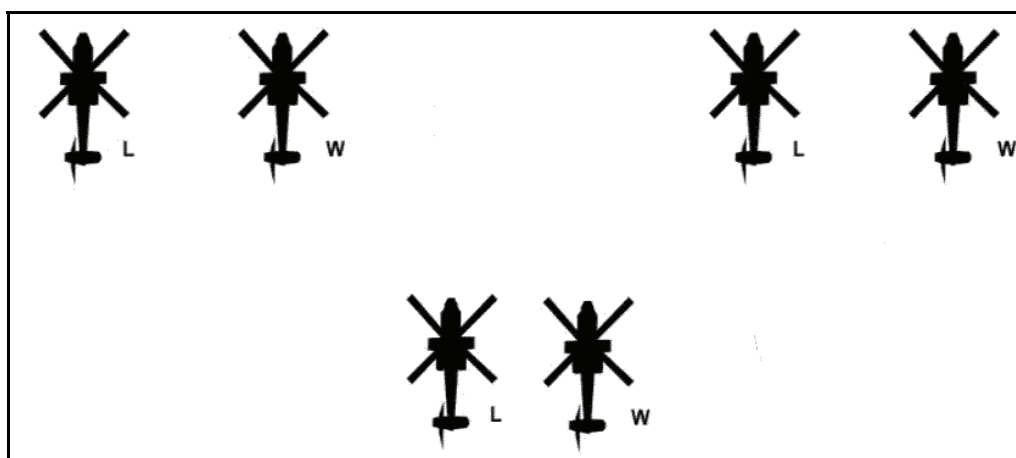

Figure 3-45. Example of a nonstandard set

3-368. When all teams are established in the ABF/BP, the commander calls “SET HOT” (teams are in position and have targets in sight) or “SET COLD” (teams are in position and do not have targets in sight). If all indications are that the enemy is in the EA and cannot be seen, the commander may have to move the teams forward to get the enemy in sensor range. Sensor range, not weapons range, is the key factor when selecting ABFs/BPs.

FIRE DISTRIBUTION IN THE ATTACK BY FIRE POSITION/BATTLE POSITION

3-369. Fire distribution for the ARC must be kept simple. Normally, this means that the EA is divided and each selected aircraft designates targets in a specified area. Many techniques are used to effectively divide up target areas. To maintain simplicity, adhere to the general principle of fire distribution—left shoots left and lead, right shoots right and rear, and center shoots center zone. PFZs are the primary method of distribution. Teams are assigned to a specific zone and utilize the general principle of fire distribution. See section V, attack operations, for a further discussion on fire distribution.

EGRESS FROM THE ATTACK BY FIRE POSITION/BATTLE POSITION

3-370. Egress from the ABF/BP occurs when the mission success criterion is met, or when relief on station is accomplished. As a rule, no more than 10 minutes should be spent in any one BP. Depending on the mission, the commander may egress prior to or after sending a BHO to the next inbound company. Once the BHO is complete, the teams egress on a planned route using terrain flight to the RP. Remaining teams cover the egress with supportive fires as necessary.

3-371. Situational awareness is critical in knowing where all teams are located. If all teams are not in visual range, present position requests and/or team lead calls with heading and distance to RP to facilitate SA.

SECTION VI – MOVEMENT TO CONTACT

3-372. A movement to contact gains initial contact with the enemy or regains lost contact. The ARC plans and executes the movement to contact like a zone reconnaissance. Unlike a zone reconnaissance, the effort focuses on finding the enemy force, developing the situation early, and preventing the premature deployment of the BCT main body. Terrain reconnaissance is conducted as necessary to support locating the enemy. As a result, movement-to-contact proceeds much faster than a zone reconnaissance. Some additional fundamentals of a movement to contact include–

- Maintaining a mobility advantage over the threat providing the higher commander maximum flexibility to develop the situation.
- Making initial contact with the threat and develop the situation enabling the main body to maneuver out of contact to an advantageous position.
- Maintaining contact unless directed otherwise by the higher commander.

3-373. The movement-to-contact terminates when the ARC reaches the objective or LOA without enemy contact or upon contact with an enemy force. Actions on contact occur rapidly at team, platoon, and company level to defeat the enemy force within its capability and prevent unnecessary deployment of other TF assets. Should the enemy prove to be too strong, the ARC establishes a screen and conducts a BHO with friendly forces.

3-374. Using joint fires, the ARC harasses, impedes, and destroys enemy elements to preclude their influence on the main body. The ARC directs ground elements to the vicinity of enemy units and supports those ground elements with fires. With its organic fire power, the ARC maintains surveillance and contains small forces until follow-on elements arrive to destroy the enemy.

SEARCH AND ATTACK

3-375. The search and attack mission utilizes smaller, light maneuver units and attack reconnaissance or air assault forces in large areas to destroy enemy forces or deny area to the enemy. Search and attack operations may be conducted against a dispersed enemy in close terrain unsuitable for ground maneuver, in rear areas against enemy SOFs or infiltrators, or as an area security mission to clear assigned zones.

3-376. The search and attack technique is best used when the enemy is operating in small teams using hit-and-run tactics over a large area in a generally decentralized manner. The purpose of this operation is defined as one or more of the following:

- Destruction of the enemy.
- Area denial.
- Force protection.

ATTACK RECONNAISSANCE ROLE

3-377. From attack reconnaissance's perspective, the search and attack mission is performed like a movement to contact or a force-oriented area security mission.

Elements of Search and Attack

3-378. The major elements of the search and attack are find, fix, or destroy the enemy.

Find the enemy

3-379. Attack reconnaissance elements find the enemy by performing a movement to contact or force-oriented area security mission. The reconnaissance is specifically focused on enemy force location and

composition, not on destruction. Stealth by the reconnaissance force is of great importance. If the reconnaissance force is able to locate the enemy without being detected, it allows the commander time to develop the situation properly with fixing and finishing elements.

Fix the enemy

3-380. If the battalion is the fixing unit, consideration must be given to augmentation with other enablers or maneuver forces unless the requirement is to fix by direct fire. The most common tactic for fixing is to block an enemy element from moving along its most likely avenue of departure. This blocking can be accomplished by mounted or dismounted elements, aviation forces, mines, or obstacles covered by fire. The key is ensuring the fixing unit has sufficient combat power and capability to react to the enemy in unanticipated locations. ARBs generally require augmentation for fixing missions depending on enemy size and capability.

Destroy the enemy

3-381. Any maneuver force with the combat power to destroy the designated enemy force may accomplish this. Attack reconnaissance elements help destroy the enemy by massing fires in a hasty or deliberate attack, either independently or in combination with ground forces. The key to success for this part of the mission is the ability to bring the destroying force's combat power to bear at the key time when the fixing force has halted the enemy's movement.

SECTION VII – PERSONNEL RECOVERY OPERATIONS

3-382. The Army's PR philosophy is one of leadership and accountability. It comprises primarily the Soldier's Creed, directed responsibilities, and practical considerations. The Army conducts PR as a collection of architecture and activities designed to affect the recovery of personnel who are isolated, missing, detained, or captured (IMDC). PR is no longer just combat search and rescue (CSAR), special operation force or air asset centric operation designed primarily for the rescue of aviators.

3-383. The Army PR function is defined as "the sum of military, diplomatic, and civil efforts to affect the recovery and return of United States military, Department of Defense (DOD) civilians, DOD contractor personnel, and/or other personnel, as determined by the Secretary of Defense, who are IMDC in an operational environment." PR is one of the highest priorities within the DOD.

3-384. Army aviation's role is in the execution of preestablished procedures and well rehearsed operations to report, locate, support, recover and repatriate IMDC personnel. Specifically, aviation is involved in the recovery of personnel within the unit's or supported units' AO when the IMDC personnel's location is known. Four principle methods of recovery are used when planning and executing recoveries—immediate, deliberate, external supported and unassisted.

- Immediate recovery is the sum of actions conducted to locate and recover IMDC personnel by forces directly observing the isolating event or, through the reporting process, determining that IMDC personnel are close enough for them to conduct a rapid recovery. Immediate recovery assumes that the tactical situation permits a recovery with the forces at hand without detailed planning or coordination.
- Deliberate recovery is the sum of actions conducted by Army forces when an incident is reported and an immediate recovery is not feasible or was not successful. Weather, enemy actions, IMDC personnel location, and recovery force capabilities are examples of factors that may require the detailed planning and coordination of a deliberate recovery.
- External supported recovery (ESR) is the sum of actions conducted when immediate or deliberate recovery is not feasible or was not successful. ESR is either the support provided by the Army to other joint TF components, interagency organizations, or multinational forces or the support provided by these entities to the Army. CAS, ISR, and airborne C2 are examples of capabilities that may be required from different components to execute an ESR.

- Unassisted recovery comprises actions taken by IMDC personnel to achieve their own recovery without outside assistance. An unassisted recovery typically involves an evasion effort by IMDC personnel to get back to friendly forces, or to a point where they can be recovered via another method. While the code of conduct requires IMDC personnel to make every effort to evade or escape, commanders must strive to recover these personnel via one or a combination of the other methods.

3-385. Attack reconnaissance units concentrate on the immediate recovery of personnel and the security escort of assets involved in a deliberate recovery. Self-extraction procedures and required cross-training should be detailed in the brigade/battalion TACSOPs and ATPs. Additionally, attack reconnaissance assets may be involved in providing security for externally supported recoveries involving joint forces. It is imperative that attack reconnaissance aircrews understand the terms, roles, and responsibilities involved in any recovery.

ROLES AND RESPONSIBILITIES

3-386. PR is a dynamic and unique mission including all levels of threat. The vast geographic area, variety of hostile defenses, and geographic separation of friendly forces demand thorough mission coordination. Each PR event has the possibility of becoming a joint mission depending on the situation of forces involved in a recovery. Some joint participants receive specialized training to execute their role in a recovery. A thorough understanding of the roles and responsibilities of all participants ensures recoveries that start as immediate or deliberate may be continued as externally supported with a minimum of confusion. This level of functionality and modularity requires an understanding of terms, recovery training and action drill rehearsals at all levels.

Personnel Recovery Terms

3-387. Any PR event has the possibility of becoming a joint mission. Additionally, the Army may be called upon to participate in civil search and rescue (SAR) operations. Therefore, it is important to note key Joint terms with regards to other services and civil SAR as well as the Army (table 3-8, page 3-89).

Table 3-8. Personnel recovery terms

Joint Terms	Army Terms	Civilian Terms
Joint Personnel Recovery Center (JPRC)	JPRC	Rescue Coordination Center
Personnel Recovery Coordination Cell (PRCC)	PRCC	Rescue Subcenter
Personnel Recovery Officer (PRO)	PRO	SAR Mission Coordinator
On-scene Commander (OSC)	OSC	OSC
Airborne Mission Commander	Operations Officer S3/Battle Captain/ C2	Aircraft Coordinator
CSAR Unit	No Army Term	SAR Unit
Helicopter Recovery Force	Helicopter Recovery Force	SAR Unit
Rescue Escort (RESCORT)	Gun Escort	No Civilian Term
RESCORT Commander	AMC (Attack)	No Civilian Term

Battalion Role

3-388. The Army has detailed the PR planning process and equipment requirements in FM 3-50.1. In many cases, the battalion or TF headquarters may act as C2, coordinator or facilitator for PR recoveries by providing assets, an OSC, coordination for recovery assets or communication relay. Overall execute authority for deliberate recoveries should be outlined in theater SOP and/or unit SOP.

3-389. Predeployment PR training/preparation for all personnel should include ISOPREP development, high risk to capture training and use of weapons, PR drills and ground to air communication/signaling procedures. Aircrews should receive additional training on SPINS data, ATO data, SOPs and self-extraction procedures. ARB CP personnel should be trained on PR procedures and have rehearsed PR missions prior to deployment.

3-390. Commanders must ensure that only forces required to accomplish the recovery are put at risk. Additional forces may only complicate the recovery planning and execution. Execution tasks for the battalion may vary based on the mission, level and type of recovery. The Air Force utilizes an airborne mission commander in much the same way as the battalion operation staff functions. (The Air Force AMC is usually on board an ABC3 capable aircraft, from which Tanker Tracks, Fighter CAPs, and other PR coordination is orchestrated). The difference being, the airborne mission commander is airborne. Some common execution tasks are—

- Appointing an OSC and coordinating OSC relief as the situation dictates. Communications capability, weapons load, fuel status, and aircraft limitations are considered when selecting the OSC. The initial OSC may be the wingman, or a ground unit in the area.
- Locating low-threat areas where the rescue assets can hold and egress.
- Determining the threat level in the isolated personnel's area.
- Obtaining evasive plan of action (EPA) data from flight operations and passes data to the recovery force, OSC, and PRCC.
- Coordinating and monitoring PR radio nets. Aircrews use an FM radio as the primary net if Army assets are only used during the operation. UHF/VHF becomes primary if the operation is inter-service or joint.
- Continuing to gather information from all sources and passing to higher in accordance with SPINS and PR plan using the search and rescue incident report (SARIR)/SARSIT reporting formats.
- Managing flow of aircraft to and from the objective area.

3-391. Battalion operations will execute additional tasks based on the mission to include—

- Briefing the designated RESCORT or PR recovery force on missions with the potential for an isolating event. This may be a part of the briefing for the QRF, or DART.
- Completing all necessary information in the rescue mission brief (RMB).
- Determining isolated personnel's available signaling devices.
- Conducting a thorough threat assessment and developing a threat map covering the following to permit protection of the recovery team:
 - Radar sites due to their ability to detect PR forces, intercept communications, and possibly direct hostile forces to the vicinity of isolated personnel.
 - Threats to primary rescue vehicles such as helicopters, antiaircraft artillery (AAA), man-portable AD systems, small-arms fire from ground forces, and armed enemy aircraft. Known or suspected enemy sites should be avoided at all times.
 - Location of restricted operating zones (ROZs) for EW and airborne C2 platforms often required for PR missions.
 - Data concerning enemy weapons and troop deployments with terrain and weapon ranges denoted. This provides PR mission planners with detailed threat information to optimally plan ingress and egress routes for rescue vehicles with respect to specific enemy weapon systems and ground forces.
- Recommending air routes to and from the area. If threats, informing RESCORT of threat positions so threats can be circumvented or additional support assets requested.
- Making a go/no-go recommendation based on information gathered at the objective area.
- Preparing isolated personnel for pick-up.

Company Role

3-392. The company's role in PR is at execution level. The commander must understand PR includes training of all aircrews and personnel in PR procedures for both execution of recovery and actions of company personnel if they become isolated. It is important that all aircrews, (including crew chiefs and engineers) know and understand the Isolated Personnel Guidance within the Theater SPINS. Rescue Forces are extremely vulnerable, especially during the Terminal phase of rescue operations, and properly trained

survivors (IPs) have a critical role in a successful mission. Procedures for immediate recoveries should be outlined in the unit TACSOP and procedures rehearsed based on the type of airframe and the circumstances for its use. This section will concentrate on procedures for a deliberate recovery or participation in an externally supported recovery. Following are terms that personnel should be familiar with.

On-scene commander

3-393. The OSC is the person designated to coordinate recovery operations within a specified area. He does not have to be in an aircraft; he may be ground or vessel based, but must be proficient in all PR procedures and have the ability to communicate with higher. While the Air Force qualifies a pilot to act as OSC, any Army aircrew may be called upon to act in this capacity. In fact, if any aircraft goes down, the first aircraft to arrive on scene (wingman) assumes OSC responsibilities regardless of proficiency. The OSC checklist may be found in the theater SPINS. While the Air Force qualifies a pilot to act as OSC, any Army aircrew may be called upon to act in this capacity. Other responsibilities of the OSC include—

- Establishing and authenticating communication with isolated personnel.
- Locating isolated personnel and passing initial information to the AMC via the RMB.
- Conducting a threat assessment of the objective area (avoid highlighting the isolated personnel's location).
- Completing the OSC checklist.
- Determining the health/condition of isolated personnel and passing status to the AMC.
- Reauthenticating isolated personnel after OSC changeover only when the situation warrants.

Rescue mission commander

3-394. The rescue mission commander (RMC) is the designated AMC that maintains control of the entire recovery during the launch, en route and terminal phase of the recovery. Careful consideration to selection of the RMC should include knowledge of the overall mission, capabilities of the helicopter recovery force, requirements for communication, night vision capabilities and joint interoperability.

Recovery force

3-395. The PR force consists of the personnel that will affect the actual recovery of the isolated personnel. This includes security personnel for the area around the extraction point; recovery personnel that authenticates and moves the isolated personnel to the aircraft; and medical personnel that provide immediate assistance to the isolated personnel or injured security force personnel. The size and composition of this force may vary with the mission supported and the perceived or actual threat. During recovery operations the RMC should be in the gun escort for SA at the objective. However, this is mission dependant.

Helicopter recovery force

3-396. The helicopter recovery force will consist of lift aircraft used to move the recovery force to and from the objective area and move the recovered IMDC personnel back to friendly forces. The helicopter recovery force will designate an AMC. The helicopter recovery force AMC will coordinate all PR Force efforts on the objective.

Gun escort

3-397. The attack/reconnaissance assets utilized to provide security escort to the helicopter recovery force may also be called the RESCORT. The primary duty of the gun escort or RESCORT is to provide protection and SA for the helicopter recovery force. The principles of air assault security are used in execution of this task. Priority is to avoid, suppress, and destroy targets posing a threat to the helicopter recovery force or recovery force on the ground and to initiate communication with OSC, or the IP if no OSC is on station.

TYPES OF ESCORT

3-398. Several types of escort methods may be used during the en route phase, but the tactics will depend on factors such as speed, altitude, distance, fuel, level of threat, weather conditions, and whether it is a day or night operation. Two common types of escort may be utilized (table 3-9, page 3-92).

- Attached escort. This method allows continuous visual or radar contact (AH-64D FCR) of the helicopter recovery force.
- Detached escort. This method includes reconnaissance ahead of the helicopter recovery force, trail escort or proximity escort. Detached escort requires knowledge of routes and planned timing or position calls.
 - If the escort sweeps ahead of the helicopter recovery force it suppresses threats along the ingress route, or redirects the helicopter recovery force to avoid enemy activity. Checkpoints or control points must be established to maintain SA and horizontal airspace deconfliction.
 - Trail escort employs the escort in a rear quadrant. This may be used for rapid linkup of the gun escort with the helicopter recovery force, but delays response time to en route engagements and puts the trail elements at more of a risk.
 - Proximity escort is similar to trail escort but allows the gun escort to fly a parallel course to the helicopter recovery force. This provides an increased survivability from surface to and air engagements and decreased probability of detection for both groups.

Table 3-9. Types of escort

<i>Type of escort</i>	<i>Advantages</i>	<i>Disadvantages</i>
Attached Escort	<ul style="list-style-type: none"> ● Good SA of helicopter recovery force assets and status ● Rapid response to threats ● Mutual response from recovery force assets. 	<ul style="list-style-type: none"> ● Escort may highlight the formation ● Increased potential for aircraft conflict due to formation ● Decreased formation maneuverability
Detached Escort	<ul style="list-style-type: none"> ● Does not highlight helicopter recovery assets. ● Allows flexibility in maneuver ● Allows escort to maximize individual tactics. 	<ul style="list-style-type: none"> ● May preclude continuous visual, radar or radio contact. ● Helicopter recovery force may not be aware of threats to assets or responsive to the threats. ● Potential for loss of mutual support.

SEQUENCE OF EVENTS

3-399. To effectively integrate into the PR architecture the unit should ensure that PR has been rehearsed exhaustively. The dynamic and unpredictable nature of this mission requires time and effort in preparation to reduce risk during execution. The gun escort mission includes, but is not limited to—

- Rendezvousing with the helicopter recovery force.
- Ingressing.
- Conducting security escort and/or suppression.
- Providing cover and/or suppression during the extraction.
- Egressing security escort and/or suppression to a friendly or permissive threat environment.

Prepermission Planning

3-400. To effectively integrate a deliberate recovery into the PR architecture the unit should ensure that PR has been rehearsed exhaustively. The dynamic and unpredictable nature of this mission requires time and effort in preparation to reduce risk during execution. A determination must be made immediately based on predetermined factors if the unit is capable of conducting the recovery or if the recovery should be conducted by externally supported assets.

3-401. Whether aircrews are being utilized as gun escort for a designated helicopter recovery force or are maintaining an on order status as part of QRF, friendly and enemy SA is of primary concern. Each aircrew should understand their role in the recovery operation. Knowledge of the helicopter recovery force procedures, the PR force actions on the ground and OSC procedures are critical.

3-402. The capabilities of the helicopter recovery force must be considered carefully. The threat, ability to provide forward firepower, locate the threat at night and maneuver must be considered when determining formation, patterns and actions on the objective.

3-403. Planning for a deliberate recovery is conducted from TF/battalion level down to aircrews performing the mission. Commanders must ensure that missions are planned using only the forces required to gain the situational advantage required to execute the recovery. This may not be achieved by aviation assets only. Aircrews assigned the PR missions must have adequate time for planning to ensure mission success. Information necessary to execute a PR mission includes—

- Call sign, type of aircraft, and number of personnel.
- Enemy situation.
- Last known location/position.
- FLOT penetration points/routes.
- ISOPREP and SPINS data for time of PR incident. (SPINS will change immediately following PR incident).
- SPINS data for time of PR incident. (SPINS SAR information will freeze immediately following a PR incident for those isolated, and change for the rest of the theater).
- EPA gathered for isolated personnel. To get an idea of the isolated personnel's intentions, confirm SAR information and signaling devices isolated personnel have available for use.
- ISOPREP information from isolated personnel's records.

3-404. Basic attack reconnaissance planning factors are the same regardless of the mission type or aircraft utilized. METT-TC and the following factors should be considered:

- Isolated personnel, location, and condition.
- Threat.
- Ingress/egress routes.
- Meteorology.
- Terrain.
- Navigation.
- Fuel (FARPs and aircraft ranges).
- Flight formation.
- ROE.
- SEAD plan.
- Elements of PR TF.
- Deception plan.
- Security.
- Defining and coordinating action at the terminal objective area.
- LZ.
- Force requirements.
- EPA.

- Aircraft destruction criteria.
- Transload required after isolated personnel pickup. Y/N? If yes, where?
- Location (FOB/CASH) where rescued personnel will be returned

Notification

3-405. The notification procedures during an isolating event should be the same whether it is unit personnel, or personnel outside the unit that has been isolated. Immediately following notification of a possible isolating incident the operations section should execute its immediate action steps which should include receiving or transmitting the IMDC's ISOPREP, EPA and the SARIR to/from the PRCC. This enables parallel planning at all levels and opens the lines of communication to receive additional assets to aid in the recovery.

Note: Updates or mission complete messages are sent to the PRCC in the SARSIT format.

3-406. Aircrews that are part of the unit's designated PR helicopter recovery force should begin preparations for launch based on mission requirements. Local SOP should outline how this is accomplished to ensure each member of the aircrew has all information required to complete their part of the mission. Sensitive IMDC information like the ISOPREP and EPA should not be carried by the recovery force.

3-407. The staff should brief the RMC on all aspects of the recovery and construct the RMB or order.

Launch and En route

3-408. Following notification and passing of the RMB or order, the helicopter recovery force and gun escort are directed to launch. The execution authority for the recovery should be outlined in the SOP. Depending on the isolated personnel's location, the helicopter recovery force launches and is expected to hold at a point outside hostile fire range until permission to enter is given by the gun escort AMC. If the initial legs of the flight to the objective area are to be conducted in friendly territory, the helicopter recovery force proceeds without gun escort (provided they are not collocated) reducing the helicopter recovery force en route time once the execute order is given.

3-409. If not collocated, the gun escort or RESCORT conducts an aerial link-up with the helicopter recovery force and conducts the following tasks:

- Reconnoiters the planned ingress route.
- Provides security for the recovery force along the designated route to the HA.
- Passes all updates to the helicopter recovery force AMC.
- Escorts the helicopter recovery force to the objective area (isolated personnel's location).

3-410. Before the recovery force is established in the objective area, the gun escort or RESCORT sets the conditions at both the primary and alternate LZ for insertion of the recovery force. Conditions that must be met include—

- No armored vehicles in the objective area.
- No indirect fire affecting the LZ.
- No unit larger than squad size in the objective area.
- No weapon larger than 7.62 millimeter.

3-411. The gun escort AMC or RMC conducts an inventory of the isolated personnel's signaling devices, directs isolated personnel (derived from the isolated personnel's EPA and from the isolated personnel guidance within the SPINS) to prepare the appropriate device for identification and briefs the pick-up plan to all participants per the RMB or order. This briefing is completed prior to the terminal area phase.

Terminal Area Phase

3-412. During the terminal area phase, the gun escort attempts radio contact with the isolated personnel in an effort to determine their precise location. When radio contact is made and the gun escort clears the objective area, the helicopter recovery force moves from the HA to the objective area. The helicopter recovery force may require vectors from the HA to the objective area from the gun escort or from isolated personnel if communications permit. Once visual contact is established, the helicopter recovery force assumes communication responsibility with the isolated personnel. The primary means of recovery is conducted by landing in the objective area, but alternate means may be required.

3-413. The gun escort or RESCORT provides overwatch utilizing preestablished orbit patterns or from an ABF during the operation. The patterns or ABF should allow coverage of any avenues of approach into the objective area and permits the gun escort or RESCORT to observe the isolated personnel's position. This should be accomplished by establishing an inner area of security around the objective area then moving outward to form an outer band of security.

3-414. RMC, gun escort or RESCORT continually reports higher or relays through airborne C2 assets on the current situation and helicopter recovery force's location throughout the mission.

Reintegration Phase

3-415. Reintegration begins once the isolated personnel is in positive control. The level of reintegration required is determined during the medical evaluation and, if appropriate, SERE debrief following an isolating event. It is important to note that an isolating event is traumatic and each Soldier will react differently based on the intensity and duration of the event. A miscalculation or lack of emphasis on the complete reintegration of an isolated soldier has unpredictable results. A well-organized and efficient reintegration program includes, but is not limited to—

- Medical evaluation and followup.
- SERE debrief.
- Psychological evaluation and followup treatment.
- Limited duty.
- Medical or psychological evacuation for continued care.

SECTION VIII - STABILITY AND CIVIL SUPPORT OPERATIONS

OVERVIEW

3-416. Stability and civil support operations are separate activities not necessarily involving armed conflict between organized forces. Attack reconnaissance units do not perform any unique missions during stability and civil support operations. They simply perform the same mission sets described above with a different operational environment and certain specific mission planning considerations. Additional information is found in FM 3-0.

3-417. During stability operations, attack reconnaissance units primarily perform its METL-related tasks and remains prepared for potential escalation to full armed conflict. During civil support operations, it uses the capabilities of its combat systems to increase effectiveness of the overall effort. Again, the battalion must remain prepared for renewed hostilities or civil disorder. Many of these missions will be performed as an integrated piece of the overall United States military capability—often in conjunction with forces from other nations, other United States agencies, nongovernmental organizations, and United Nations forces. Therefore, leaders should familiarize themselves with joint operational procedures and terms.

3-418. Combatant commanders employ attack reconnaissance helicopter forces in stability operations outside the United States to promote and protect United States national interests. The purpose of stability operations is to establish civil control and reconstruct or restore essential services and governance. These operations include developmental, cooperative activities during peacetime and coercive actions in response to crisis. Stability operations are normally nonlinear and often conducted in noncontiguous AOs.

3-419. Civil support operations are operations conducted in the United States and its territories to assist civil authorities as they prepare for or respond to crises and relieve suffering. The purpose of civil support operations is to support civil authorities and law enforcement, protect military and civilian critical assets, and reinforce civil authority in disaster response. Attack reconnaissance forces provide essential support, services, assets, or specialized resources to help civil authorities deal with situations beyond their capabilities. In extreme or exceptional cases, United States forces may provide relief or assistance directly to those in need. More commonly, they help civil authorities or nongovernmental organizations provide support.

3-420. During declared disasters or emergencies within the United States, battalions may be called upon to supplement efforts and resources of state and local governments for Homeland Defense. Such operations may include responding to natural or manmade disasters, controlling civil disturbances, conducting counter-drug activities, combating terrorism, or aiding law enforcement. The battalion may be employed to augment C2 requirements, provide security for air movement, search for casualties, and assess damage.

PLANNING CONSIDERATIONS

3-421. The battalion commander faces challenges that may differ from those involved in conventional operations. A discussion of some of the planning factors commanders must consider follows.

MISSION ANALYSIS

3-422. Perhaps the greatest obstacle for the commander to overcome in stability and civil support operations is defining the mission for the unit. When he receives the OPLAN, OPORD, or implementing instructions, mission analysis begins. The commander must pay particular attention to limitations placed upon him by the ROE or political considerations.

TASK ORGANIZATION

3-423. Task organization for stability and civil support operations is METT-TC driven. The commander must assess the battalion's capabilities versus the mission, and determine if task organization is capable of accomplishing assigned missions. If not, the commander should modify the organization.

COMMAND RELATIONSHIPS

3-424. It is critical the command relationships for stability and civil support operations be established early. Elements of the battalion may deploy for stability and civil support operations without its parent headquarters. Attack reconnaissance units may be called on to support the United States government, host nation, and international agencies. These agencies may not have the military style chain of command to which United States Soldiers are accustomed. Prior coordination and flexibility are keys to mission success. The chain of command, support responsibility, reporting requirements, and authority to approve specific actions must be clearly understood by all parties prior to initiating the mission. Units must maintain liaisons with local police, air traffic control, and civil and military authorities. A clear understanding of the command, control, and support relationship helps reduce confusion and allows the unit to integrate with their controlling headquarters early and with proper resource support requirements.

ADVANCE PARTY OPERATIONS

3-425. Advance party personnel need a comprehensive overview of their unit's mission, capabilities, requirements, and commander's intent prior to deployment. They must coordinate with the gaining or outgoing command, higher headquarters, and local population. The commander must carefully select advanced party (ADVON) personnel. For example, deploying to another country with an undeveloped logistics base may require the advance party be heavily logistics weighted and contain foreign language specialists, while other missions such as counter-drug operations can be weighted with operational personnel. Whichever the commander chooses, the advance party must receive guidance and focus prior to

deployment. The advance party must also keep the commander informed as to their actions and current situation.

SPLIT-BASED OPERATIONS

3-426. The battalion, or some of its elements, will often deploy on stability and civil support operations into a theater having an immature logistics base. Logistics operations may be conducted in theater from the unit's home station. This is termed split-based operations. The commander who deploys on a split-based operation must consider the type of support required from home station. He must pay special attention to communications between the theater of operations and home station, and to the transportation means available to provide a timely flow of logistics.

SPECIAL CONSIDERATIONS

3-427. There are several key employment guidelines for the battalion commander to consider during the planning process. These guidelines are preparation, specialty augmentation, host nation requirements, ROE, and rules of instruction (ROI).

PREPARATION

3-428. Battalion and companies should expect a wide range in the tempo of operations and plan accordingly. Staff must be able to adjust rapidly to many different operational considerations. They must plan ahead and have contingency plans for numerous situations not normally addressed in the unit's METL. These situations can be identified and trained at home station. Examples of situations include civilians on the battlefield, media relations, public affairs, and defense against terrorism.

SPECIALTY PERSONNEL AUGMENTATION

3-429. Operational conditions of stability and civil support operations frequently require integration of specialty personnel with battalion staff including CA, PSYOPS, Staff Judge Advocate (SJA), and Special Forces personnel. Besides specialty staff personnel, battalion may be required to operate with infantry, armor, artillery, engineer, sustainment, or a combination of these and other assets. Whatever the composition, staff must be fully integrated to coordinate and plan operations. LNOs from the battalion to other units and from supporting units to battalion are critical.

HOST NATION REQUIREMENTS

3-430. Airspace restrictions, flight clearances, refueling procedures, civil and military laws, environmental laws and regulations, radio frequency usage, ground convoy clearances, and product disposal procedures vary from country to country. The commander must adapt unit procedures to the host nation's operating environment and procedures. Serious complications can develop when host nation requirements are not met, with repercussions ranging from mission restrictions to mission failure. In some situations, battalions conducting stability operations may be included on the air component commander's ATO to ensure SA and reduce possibility of fratricide.

HOST NATION CONSIDERATIONS

3-431. Commanders must adapt to local procedures to accomplish the mission. They must consider factors such as civil and military laws, environmental laws and regulations, airspace procedures, radio frequency usage, ground convoy clearances, flight restrictions, local customs, and host nation contracting prior to executing stability operations.

EMPLOYMENT

3-432. The majority of missions assigned to battalions during stability and civil support operations will either conform to or build upon their standard reconnaissance and security roles. Generally, the major

differences in unit operations during stability and civil support operations will be in the C2 relationships between the battalion and its higher headquarters, and the greater requirement for restraint in potentially hostile situations.

RULES OF ENGAGEMENT

3-433. ROE are designed to control the application of force. ROE are prepared and issued by higher headquarters. Commanders must clearly understand the ROE and ensure all Soldiers in the unit understand them. ROE situations should be rehearsed in detail prior to deploying or executing a mission. No situation should occur in which personnel are unsure whether to use force, and what types of force—including deadly force—are warranted. For ROE assistance, the commander should consult with the SJA representative.

RULES OF INTERACTION

3-434. ROI embody the human dimension of stability operations; they lay the foundation for successful relationships with the myriad of factions and individuals playing critical roles in these operations. ROI encompass an array of interpersonal communication skills, such as persuasion and negotiation.

3-435. ROI are tools the individual Soldier will need to deal with the nontraditional threats prevalent in stability operations, including political friction, unfamiliar cultures, and conflicting ideologies. In turn, ROI enhance the Soldier's survivability in such situations. ROI, when applied with good interpersonal communication skills, improve military personnel's ability to accomplish the mission while reducing possible hostile confrontations.

3-436. ROI are based on applicable ROE for a particular operation; they must be tailored to specific regions, cultures, and/or populations affected by the operation. Like ROE, ROI can be effective only if they are thoroughly rehearsed and understood by every Soldier in the unit.

SECTION IX – URBAN OPERATIONS

3-437. In urban areas, fields of fire are restricted, landing areas are limited, and buildings provide cover for enemy forces to engage helicopters with near impunity. The presence of noncombatants, protected structures, and important resources and facilities normally demands careful weapons and munitions selection minimizing collateral damage. The proximity of enemy and friendly ground forces increases risk of fratricide. Communications may be degraded by numerous structures. Thermal effects from paved surfaces and channeling effects of buildings can cause wind conditions to vary significantly from point to point. Special, restrictive ROE should be expected. Maintaining standoff is essential to aviation survival. Other important characteristics of aviation in urban operations include—

- Weather, especially wind patterns, directly affects urban areas.
- Numerous buildings and streets and few map references complicate navigation over built-up areas. Flight routes over urban terrain may increase employment time and fuel consumption.
- Buildings limit maneuverability and engagement ranges.
- Urbanized terrain may limit FARP size, location, and response times.
- Extensive urban sprawl and high buildings degrade communications and may require extensive relay and transmission sites.
- Urbanized terrain masks intelligence and EW acquisition capabilities.
- Landing and PZs may be severely limited; operations from rooftops may be required.
- Aviation units face increased hazards to flight operations—towers, wires, and antenna hazards.
- Night-vision system degradation due to city lights and thermal imagery create challenges in the city.
- Aircraft are at high risk, complicated by close proximity of both friendly forces and noncombatants, from close-range, small-arms fires.

- Degraded visibility and toxic fumes are possible when flying near or through smoke and dust.

3-438. Manmade structures and density of noncombatants in urban terrain affect tactical options available to commanders and aircrews. Whether engaged in offensive, defensive, stability or civil support operations, aviation units may conduct missions in urbanized terrain. This is due not only to growing populations but also a potential adversary's tendency to create a nonlinear operational environment rather than face United States forces directly. Potential adversaries can be expected to use urban terrain for cover and concealment, and to reduce United States combat superiority by taking advantage of weapons restrictions and reduced options available to commanders under ROE, ROI, and law of war. ROE and ROI must be rehearsed, practiced, and reinforced continually throughout the operation. FM 3-06 and FM 3-06.1 contain additional information. Aviation enhances urban operations by providing—

- Reconnaissance.
- Speed of resupply.
- Rapid troop movement.
- Evacuation of personnel and equipment.
- Cooperative maneuver.
- Precision fires in support of ground forces.
- Ability to quickly and efficiently transition to new missions.

PLANNING CONSIDERATIONS

3-439. Operations in urban terrain generally follow the same planning and execution concepts as in other terrain; however, special planning and consideration of characteristics unique to urban terrain are required. Aircraft must standoff to engage targets in urban areas. Overflight and engagement of targets within urban areas may require night operations and special preparation due to possible enemy direct fire at very close range. Hovering in urban areas exposes aircraft to small arms fire and should only be done if essential to the mission and adequate overwatch fires are available. Other planning considerations include the following:

- **Through knowledge of key terrain.** Operations require a thorough knowledge and understanding of key terrain (intersections, roads, hospitals, schools, cultural, religious, and municipal buildings), flight routes in and out of the AO, and flight hazards (towers, wires, canals, and power lines).
- **Do not be predictable.** Use alternate flight routes and checkpoints. Plan and vary times for egress and contingency routes, rally procedures, and backup navigation times.
- **Minimize signature.** Take maximum advantage of flight profile options and existing conditions lessening risk of acquisition and engagement. Plan and execute the mission with maximum emphasis on aircraft signature reduction. Fly at medium to higher airspeeds, depending on altitude and hazards, decreasing the opportunity for engagement by ground weapons.
- **Know the current situation.** Insist on the most current information available regarding friendly forces, demographics of the local population and enemy, and hazards. Update information prior to takeoff, en route to the objective, and continuously during the mission.
- **Establish communications with all players.** Determine net information for all participating and supporting elements. Establish communications with ground maneuver elements as soon as possible en route to the objective.
- **Confirm weapons engagement.** Develop a clear understanding of the friendly situation before engaging targets to minimize fratricide. Ensure IFF and ASE are working, and know the purpose and demarcation lines for IFF and ASE. Select the proper weapon system producing the desired effect while minimizing collateral damage and maximizing standoff.
- **Ensure airspace deconfliction.** Establish boundaries for aircraft operating in the AO. Prior coordination with other aircraft not in flight and UAS reduces facilitates airspace deconfliction. See and avoid is difficult at night in an urban environment due to city lights and mixing of aircrews utilizing NVDs and FLIR.

3-440. Due to dynamics of urban growth, current maps and photographs are essential for accurate planning. In the absence of these materials, detailed reconnaissance is required to minimize risk.

ROUTE PLANNING AND NAVIGATION

3-441. Navigation over urban terrain can be more difficult than natural terrain as most maps do not show vertical development of urban terrain. Cities are compartmented, causing small navigational errors to have significant effect. High density and similarity of structures and variety of geographical references can cause confusion. Navigation in the city can be overwhelming due to an overabundance of visual cues.

3-442. If electrical power is still available, high ambient light levels can create problems with NVD. Familiar landmarks may disappear, become covered with rubble, or be obscured by smoke and dust during flight. Other factors in route planning and navigation include—

- Using vertical and linear references to distinguish en route checkpoints. Choosing easily recognizable features such as cemeteries, stadiums, cathedrals, radio towers, tall buildings, and major roads. Highways, rivers, railways, canals, and coastlines provide easily recognizable boundaries and references to assist in maintaining orientation. Prominent rail and highway interchanges are useful as en route checkpoints.
- Obtaining maps with proper information for both navigation and synchronization with ground maneuver elements. Photomaps of the village, town, or city are great tools.
- Using an area sketch for target areas and objectives. Area sketches identify natural and manmade features in the area and code them with letters, numbers, or code words. Identification of targets and friendly unit location is much easier with both air and ground units using the same area sketch. Figure 3-46, page 3-103, provides an example of an area sketch.
- Converting civilian maps to the military grid reference system (MGRS). Civilian maps also include names of streets and key buildings, locations, and terrain within the city.
- Using GPS to ease the problems associated with navigation in urban areas. GPS does not eliminate need for other navigational methods. Navigation may be degraded due to interference inducted by buildings and GPS jammers.
- Using a network route structure “spider web” of ACPs and air routes (preferably surveyed) to facilitate route planning, navigation, and C2. ACPs are placed on easily identifiable features, then linked together to form the route. The spider web concept provides many different routes and variations of routes using established checkpoints. However, any type of route structure may lead to predictability. See figure 3-47, page 3-104, for an example of a spider web route structure.

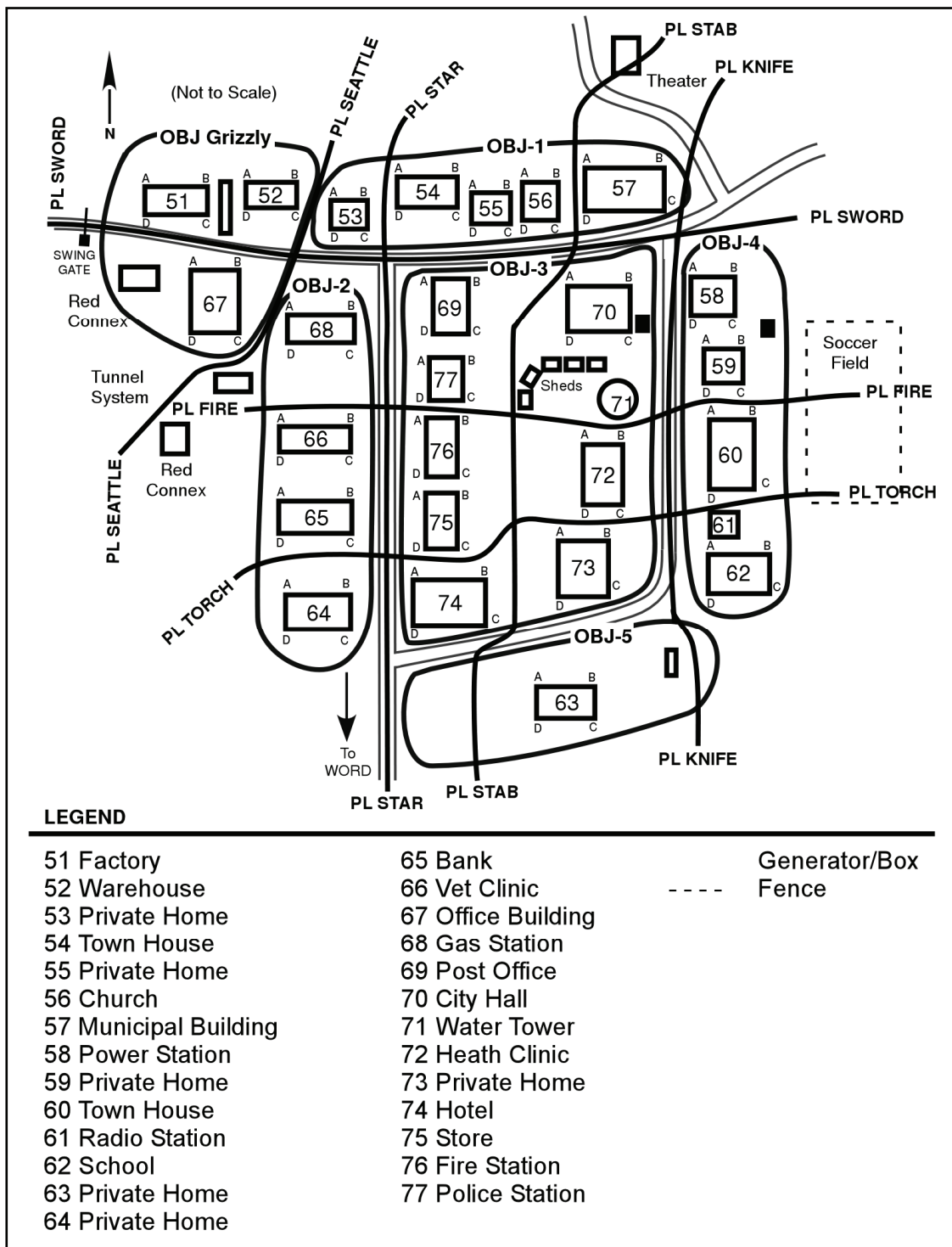

Figure 3-46. Example of an area sketch

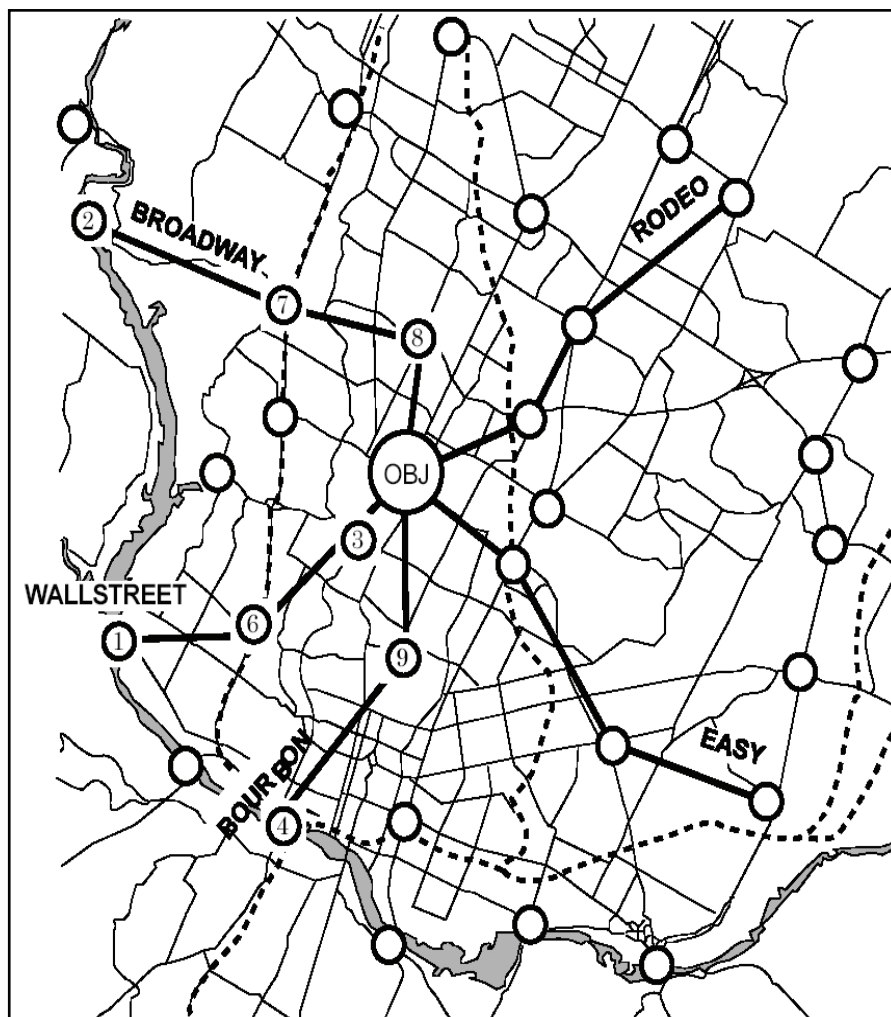

Figure 3-47. Example of a network “spider web” route structure

LANDING ZONE, PICKUP ZONE, AND FORWARD ARMING AND REFUELING POINT SELECTION

3-443. Units must look at all available products to find suitable sites for LZs, PZs, and FARPs. City maps, overhead imagery, and reconnaissance flights help identify proper sites. Consider use of city parks, parking lots, stadium fields, and athletic fields. Major highways and large multilane roads offer potential LZ, PZ, and FARP sites if civilian traffic is not using them.

3-444. Hazards effecting selection of LZs, PZs, and FARPs include antennas, light poles, debris, wires, enemy locations, and winds. Winds may change direction because of buildings and built-up areas. Tall buildings may funnel winds through the streets, causing a much higher wind condition than briefed. Lighting at LZs, PZs and FARPs is a factor. If the city is not blacked out, city lights affect NVDs.

DIRECT FIRE PLANNING CONSIDERATIONS

3-445. When fighting in urban terrain, most targets are fleeting and near the identifying Soldier. Few personnel targets will be visible beyond 50 meters, and engagements usually occur at 35 meters or less. Helicopter engagements supporting troops in such proximity require careful coordination and execution. To reduce risk of fratricide, aircrews must be familiar with minimum arming distances and risk-estimate

distances. Falling debris from urban structures can be as deadly as shrapnel. FM 3-09.32 contains additional information regarding danger close ranges. Other planning considerations include the following:

- Urban terrain is severely canalized causing severely limited fields of fire.
- Streets limit target views to a narrow corridor along the street or from high angles over buildings.
- Enemy forces utilize near sides of buildings, putting them out of view.
- Targets move rapidly from cover to cover and require quick engagement.
- When forced to fight and fly over areas where the enemy has not been cleared, it is better to keep aircraft moving and make it a harder target to hit.
- Running fire generally offers better aircraft survivability. Conduct running fire engagements from an initial point, engaging the target, and returning to a safe area to regroup for another attack. The lead wingman concept is excellent for this type of attack. The wingman can suppress the target after the lead engagement and “cover the break.” When using running fire, aircrews must be aware of overflight of friendly units, although ground units provide suppressive fires to protect aircraft during the attack. Figure 3-48 provides an example of running fire engagement technique.
- Hovering fire allows aircrews to unmask both laterally and vertically from behind cover. However it is the least recommended in urbanized terrain since aircrews must maneuver within 2,000 meters to observe the target. Figure 3-49, page 106, shows an example of the hovering fire technique.

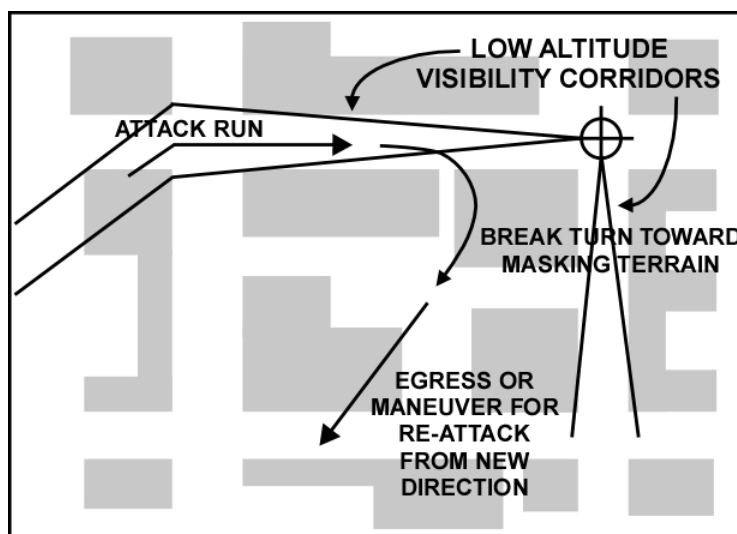

Figure 3-48. Example of running fire technique

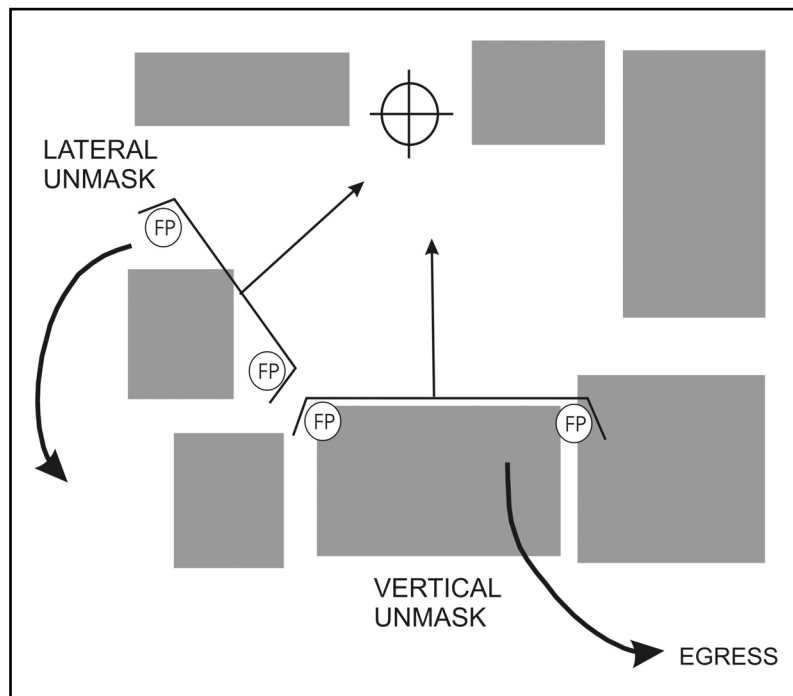

Figure 3-49. Example of hovering fire technique

Targeting Grids and Reference Techniques

3-446. Ground elements generally use a terrain-based reference system during urban operations. MGRS coordinates have little meaning at street level. Aviation and ground forces must use common control methods. Possible techniques include urban targeting grid system, objective area reference grid (bull's-eye targeting technique), and TRPs technique. These techniques are based on the street and structure pattern without regard to the MGRS. Using common techniques allows aircrews to make the transition to the system in use by the ground element upon arrival in the objective area. For example, references to the objective or target may include local landmarks such as “third floor of the Hotel Caviar, southeast corner.” This transition should be facilitated by using a “big-to-small” acquisition technique.

Urban targeting grid system

3-447. The urban targeting grid system is a technique dividing the urban area into specific grid sectors. A number or letter identifies each building. Coding the corners of buildings facilitates rapid fires. Target handover to the aircrew is simply the location from the grid system and a brief target description. Aircrew and ground unit must have the same urban targeting grid for effective coordination to occur. Figure 3-50, page 3-107, provides an example of the urban targeting grid system.

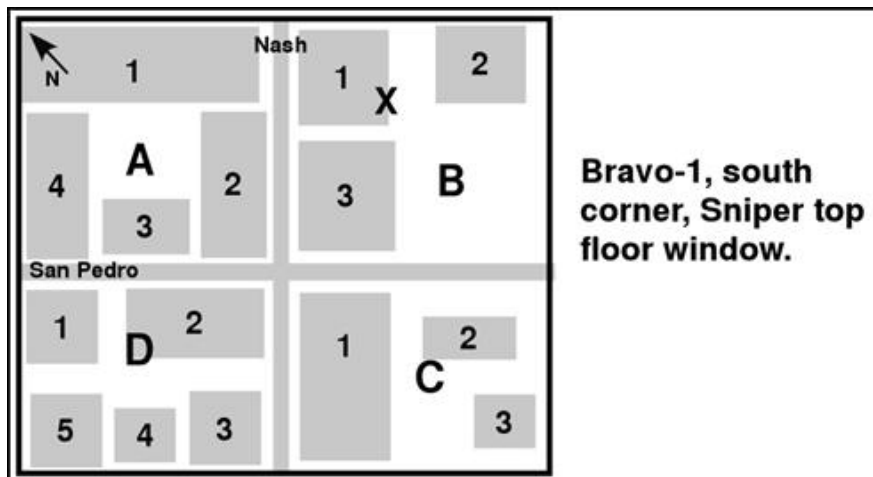

Figure 3-50. Example of urban targeting grid system

Objective area reference grid technique

3-448. The objective area reference grid technique, also known as the bull's-eye method, gives the aircrew a specific point and reference target location from that point. The bull's-eye must be a point that is easily recognizable for both the unit in contact and the aircrew flying the mission. The bull's-eye may be preplanned or given to the aircrew on site. As long as the aircrew and the ground unit are working from the same map or both are familiar with the area, bull's-eye targeting is very effective. Target handover to aircrew is simply a distance and direction from the bull's-eye and a target description. Figure 3-51 provides an example of the objective area reference grid technique.

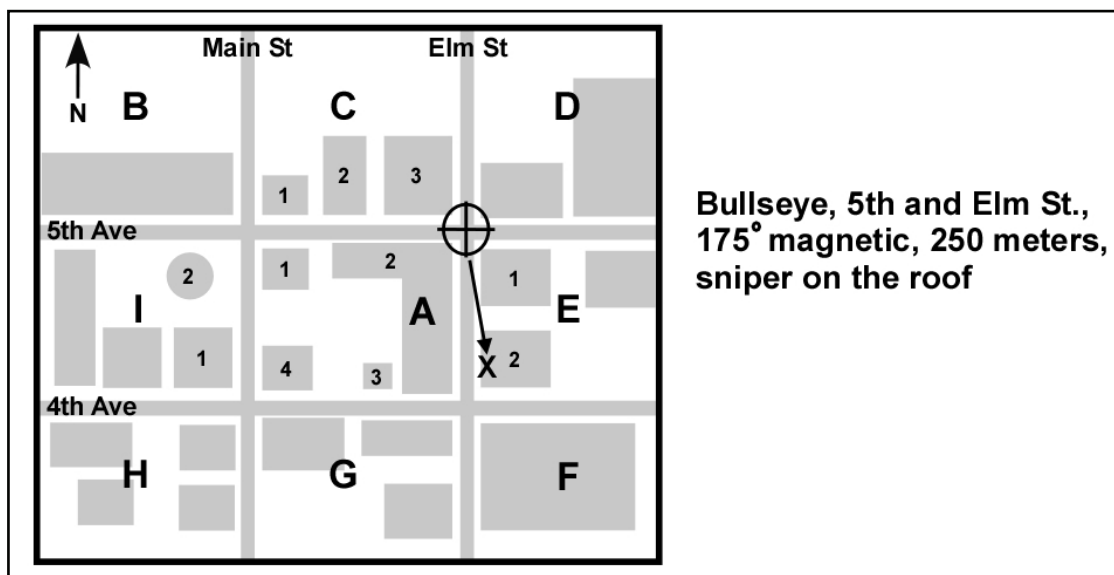

Figure 3-51. Example of objective area reference grid system

Target reference points technique

3-449. TRPs are tools air and ground units can use to coordinate fires. They are easily recognized points on the ground (either natural or manmade) used to initiate, distribute, and control fires. TRPs are

designated by maneuver leaders to define sectors of fire or observation. They can also designate the center of an area in which the commander plans to converge or distribute fires of his weapons rapidly. Target handover is similar to bull's-eye targeting; a distance and direction from the TRP and a brief target description. Figure 3-52 provides an example of TRPs technique.

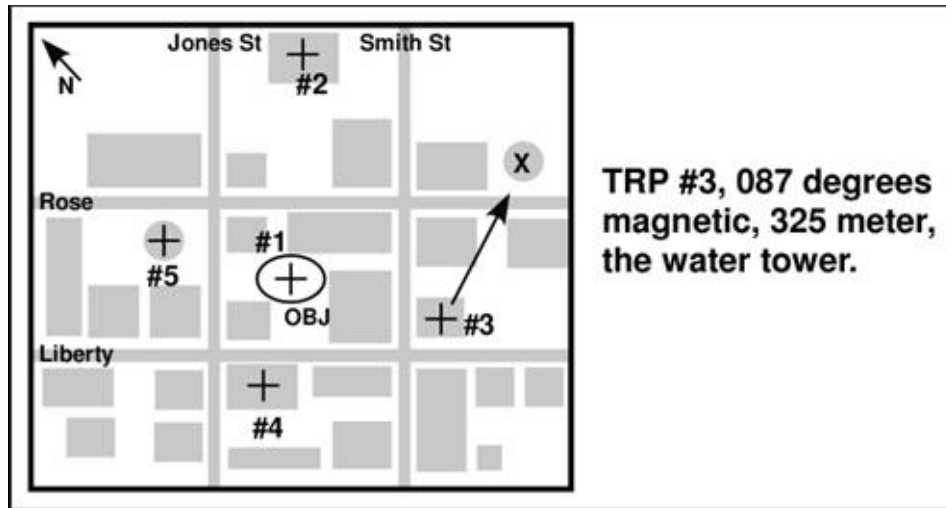

Figure 3-52. Example of target reference points technique

Building marking technique

3-450. The building marking technique gives the aircrew a specific location in reference to a building or fixed structure. All buildings sides are numbered clockwise with the front being the starting point. The designated front is normally along the main street or main avenue of approach (figure 3-53, page 3-109). The floors, windows, and openings of the structure are labeled numerically (floors) and then alphabetically (windows, openings). Numbering of the floors begins with the ground floor and ascends to the top floor. Windows and opening are assigned letters, beginning with A, and are labeled from left to right. The lettering sequence begins over with each floor ensuring all windows, openings, and obvious holes and/or breaches are assigned the appropriate letter. This technique may also incorporate a direct description (the window to the right of the flames). Figure 3-54, page 3-110, depicts an example of floor and window lettering convention.

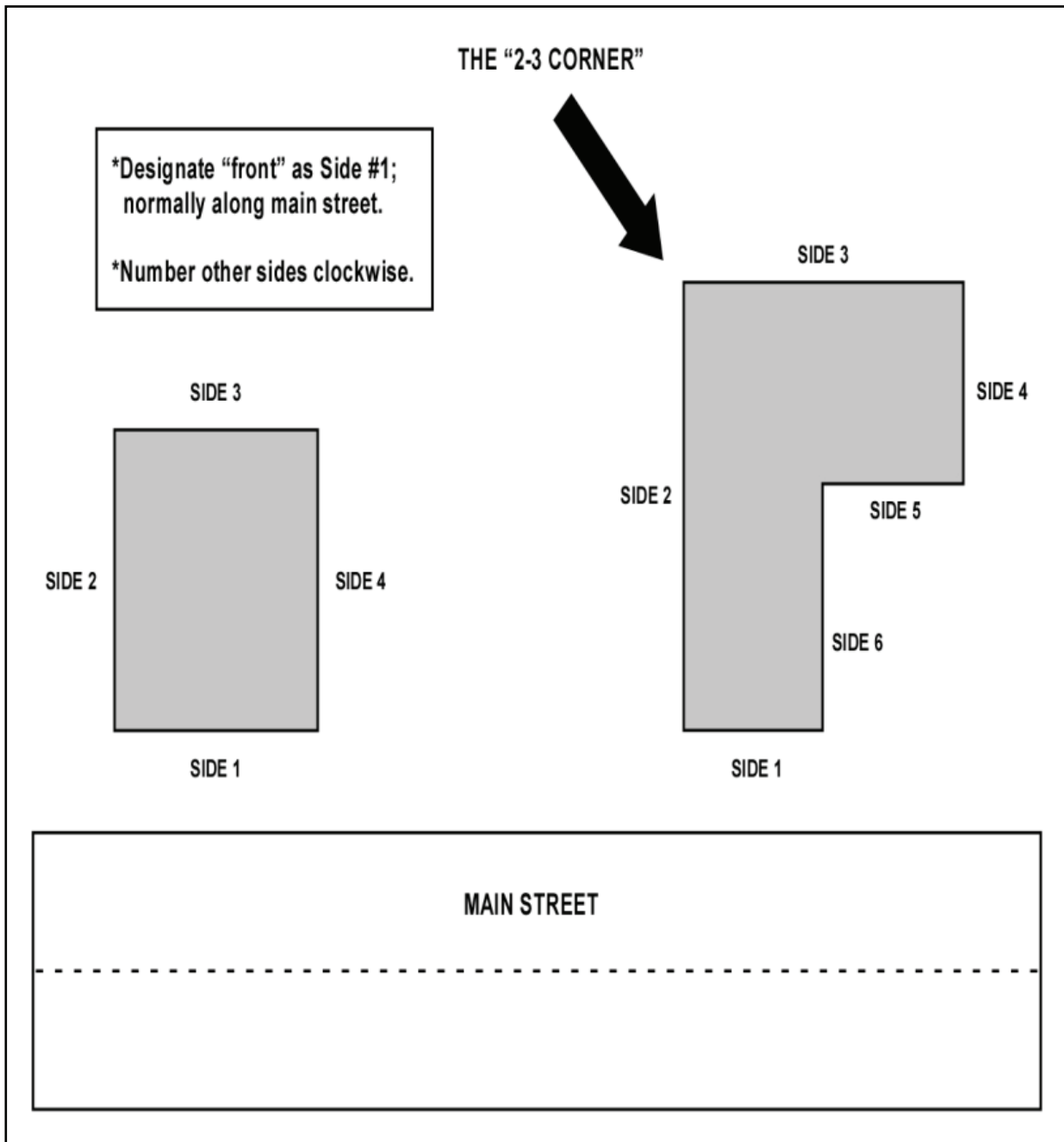

Figure 3-53. Example of building numbering convention

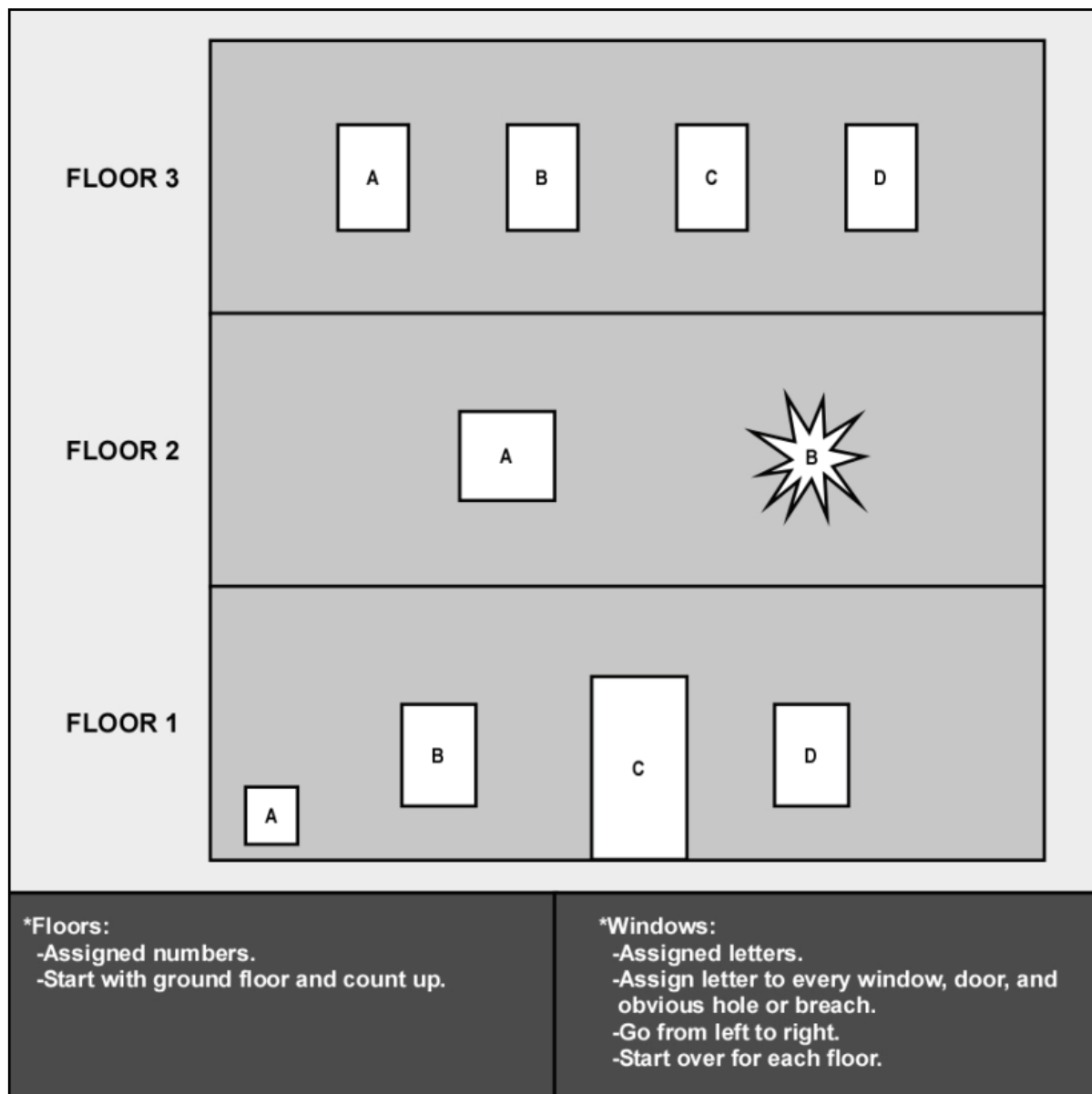

Figure 3-54. Example of floor and window lettering convention

Aviation Weapons Effects

3-451. In urban terrain, targets rarely present themselves for extended periods of time. Aircrews can expect short target exposure and rapid engagement; aircrews must be constantly on the lookout for targets and ready to engage. Aircrews must expect enemy-held structures to be covered by fire and dead space within urban areas. Large, tall buildings and narrow streets create dead space aircrews cannot cover. If enemy units are in buildings, the buildings must be attacked first to get to the threat inside. Weapons able to break through walls must be used. Weapons found on aircraft designed to destroy vehicular targets and troops in the open are also effective in the urban environment. Other considerations for fires in urban areas include the following:

- Minimum arming and slant ranges within urban areas limit use of some weapons.

- Heavy concentration of precision weapon systems along a narrow front may cause coordination problems.
- Precision weapons can cause fratricide if planning is not precise.
- Multiple flat, polished surfaces in an urban area may degrade laser use.
- Urban targets are usually hard and smooth, and contain flat surfaces. Rounds fired from the air strike the surface at an angle and tend to ricochet, causing impact-fused weapons to not detonate.
- Heavily developed urban centers can limit CAS.
- Direct and indirect suppressive ground fire should augment the escort suppressive fires as air assaulting forces approach intended LZs.
- Operations could be in areas with a high potential for significant civilian injury and collateral damage of property, specific knowledge of weapons effect is critical.
- Hellfire missile precision may minimize collateral damage. Due to its accuracy, the use of a Hellfire missile may be appropriate eliminating such targets as a sniper or machine-gun nest. Selection of the correct type of Hellfire warhead is also critical.

Machine Guns

3-452. Though considered an area fire weapon, the 30-millimeter cannon is very accurate and may be employed against a single person or groups. It can penetrate walls of most conventional structures.

3-453. The 50-caliber and 7.62-millimeter machine gun are both area fire weapons, but do not have penetration capability of the 30-millimeter. The 50-caliber does possess a greater effect than the 7.62-millimeter. Both are good for suppressive fires and against nonarmored targets.

Rockets

3-454. The 2.75-inch rockets suppress and destroy targets. As currently configured, these are area fire weapons, whose accuracy is tied directly to crew proficiency. Running or diving fire often yields the best results. Rockets are effective against troops and equipment in open streets and plazas when enough standoff and maneuver room is available. High explosive rounds produce the best effects on buildings whereas flechette rounds are effective for clearing rooftops or attacking troops in the open. Smoke rounds are excellent for masking friendly movement.

Missiles

3-455. Hellfire missiles produce effects on structures found in urban environments. The precision of a Hellfire missile may minimize collateral damage. Due to its accuracy, the use of a Hellfire missile may be appropriate eliminating such targets as a sniper or machine-gun nest. It also gives aircrews the ability to target specific windows, floors, or sections of a building. Selection of the correct type of Hellfire warhead is also critical.

OPERATIONAL PHASES

3-456. There are five distinct phases to urban operations—reconnoiter the objective, move to the objective, isolate the objective, secure a foothold, and clear the objective. ARBs can expect missions during each phase of the operation.

RECONNOITER THE OBJECTIVE

3-457. Aviation units assist the ground unit in a thorough route, area, and zone reconnaissance of the objective to complete the operation. Planning considerations for reconnaissance remain the same, focusing on the following critical tasks:

- Conducting route reconnaissance of the routes leading to and from the urban area (both ground and air).

- Conducting zone reconnaissance of areas around the city.
- Conducting area reconnaissance of key terrain or areas leading to the city.
- Conducting IAs or CCAs on enemy units found during this phase of the operation.
- Providing security during insertion of scout and long-range surveillance teams.

MOVE TO THE OBJECTIVE

- 3-458. Critical tasks the ARB accomplishes during this phase of the operation include—
- Continuing aerial reconnaissance operations to detect enemy forces, positions, and obstacles and prevent them from interfering with the operation.
 - Supporting air assaults with area reconnaissance of air route and LZ/PZs.
 - Conducting a screen of a moving force as ground units move along their attack routes into the urban area.
 - Conducting a zone reconnaissance to locate and defeat enemy forces along the route or in areas influencing ground scheme of maneuver.
 - Continuing to identify routes or confirm previously cleared routes are still free of obstacles.
 - Conducting CCA and IAs on enemy units and positions.
 - Supporting repositioning of ground forces to assault positions.
 - Supporting movement of supplies by air.

ISOLATE THE OBJECTIVE

- 3-459. Critical tasks accomplished during this phase include—
- Isolating the objective to prevent the enemy from escaping or reinforcing the urban area.
 - Conducting screens to provide early warning of incoming enemy forces attempting to reinforce the city.
 - Helping develop the situation.
 - Destroying enemy forces.
 - Assisting with BHOs.
 - Securing a foothold
 - Securing a foothold involves seizing an intermediate objective providing cover from enemy fire and a place for attacking troops to enter the built-up area.
- 3-460. Critical tasks the ARB provides during this phase include—
- Conducting area reconnaissance to determine possible enemy forces, weak points, flanks, and enemy composition.
 - Massing aviation fires to assist ground units with establishing a foothold.
 - Conducting area security, reconnaissance, or other security missions maintaining isolation of the urban area.
 - Providing suppressive fires from ABFs, SBFs, or BPs.
 - Employing precision fires to destroy enemy armor on high-speed avenues of approach into the city.
 - Coordinating with JAAT to destroy armored forces securing the breach point.
 - Providing laser identification of targets.
 - Providing security for assault units transporting ground forces to the area.
 - Continuing to conduct reconnaissance, security, and CCA to maintain isolation of the city.

ASSIST IN CLEARING A BUILT-UP AREA

3-461. Clearing a built-up area is characterized by systematic house-to-house fighting as ground forces attempt to force the enemy from the city. Planning considerations include those associated with cordon and search and also include the following tasks:

- Continuing isolation of city operations.
- Conducting reconnaissance and security operations in the city to support ground units in contact.
- Screening outside the city to prevent reinforcements from arriving or the enemy resupplying the city.
- Conducting reconnaissance within the city that supports assault units, repositioning forces, or forces conducting aerial supply.
- Conducting IAs and CCA missions in support of the unit in contact.
- Reconnoitering LZs in large parking lots, city parks, athletic fields, and on buildings.
- Supporting CASEVAC missions.

AIRCREW URBAN THREAT CONSIDERATIONS

3-462. Some special considerations for threat in urban operations include the following:

- Enemy forces may infiltrate urban terrain and ambush helicopters from positions inside buildings. The presence of snipers increases the vulnerability of ambush.
- Every building and structure in an urban area is a potential enemy position.
- Portable surface-to-air missile systems are difficult to detect in and among buildings.
- Difficulty in distinguishing combatants from noncombatants places participants under additional psychological stress.
- Defending forces normally have the advantage of familiarity with terrain.
- Aircraft are more vulnerable to low-tech weapons in urban combat.
- Because LZs may be scarce and, therefore, predictable, air assault operations in mass may be vulnerable to enemy fires.
- Urban terrain provides excellent cover and concealment for a variety of weapon systems. Coupled with restrictions on airspace available for maneuver, this makes these weapons a more significant threat to aircraft than they normally are in open terrain. Some of these weapons include—
 - **Tank main gun.** Modern fire control systems permit effective aircraft engagement by tanks with their main gun. Development of effective anti-helicopter ammunition, such as the United States-fielded multi-purpose anti-tank round, includes an air/ground fuse.
 - **ATGMs.** Most ATGMs have an effective range of between 3,000 and 5,000 meters and can engage helicopters in the same way they engage ground targets. ATGMs are a threat to rotary-wing aircraft in an urban environment due to restriction and compression of airspace and operating closer to potential threat positions.
 - **Antiarmor rockets.** Antiarmor rockets, such as the rocket propelled grenade are readily available, inexpensive, and normally standard equipment at the small unit level, even in irregular forces. They are unguided and have effective ranges of less than 500 meters and are a real threat to rotary-wing aircraft.
 - **Medium cannons.** Many armored personnel carriers (APCs) and infantry fighting vehicles carry rapid-fire cannons ranging from 20 to 40 millimeters, and are effective against rotary-wing aircraft.
 - **Small arms and machine guns.** Small arms and machine guns can also become a more significant threat in an urban environment. Generally, 5.56-milimeter and 7.62 x 39-milimeter rifles are effective up to 500 meters, 7.62-milimeter machine guns and sniper rifles of similar caliber are effective up to 1,000 meters, and .50-caliber/12.7-milimeter machine guns and sniper rifles are effective up to 2,000 meters. Another consideration is these weapons can be placed on the upper floors of buildings above the helicopters to fire

down on the helicopters. Since these are small, light weapons, they can be easily moved to unexpected positions easily.

RECONNAISSANCE OPERATIONS

3-463. Varying terrain in urban environments poses several challenges for attack reconnaissance teams conducting reconnaissance missions. There are a wide variety of small villages/towns and NAIs in flat areas as well as nested on a hill or arrayed on both sides of a valley. These areas make a clear FOV for observation very difficult and sometimes unavailable without having an aircraft fly right up to or over the reconnaissance objective. UAS and joint sensors may provide assistance while conducting reconnaissance in urban environments.

URBAN AREA WITH MOUNTAINOUS TERRAIN

3-464. To gain valuable observation of the target area or confirm or deny activity in the urban area, it may be necessary to utilize the following:

- **AMPS of Falcon view.** Use AMPS to check LOS from a vantage point close enough to the reconnaissance objective without compromising security for the attack reconnaissance team.
- **Overlapping FOVs.** Overlap FOV of the attack reconnaissance teams from different angles to the target. By choosing a series of OPs surrounding the objective area, the team will be able to cover two of the cardinal directions while still providing security to the other aircraft if needed. Keep movement between the lead and wing aircraft to provide total observation and gain SA. It may become necessary to place the lead aircraft at a vantage point higher than the target to see the topside, and the wing aircraft at the bottom side of the target to gain observation of the entire target.
- **Obstacle FOV.** Conducting technical map reconnaissance, in conjunction with AMPS LOS, is a proven method of gaining observation from the planning phase. The only caution when gaining the best vantage point to the objective is taking into account vegetation and manmade structures that become a hindrance to LOS. There are times the best FOV is accomplished by checking rise-over-run and keeping the team high enough to maintain observation. At times it may be prudent to be deceptive and maintain a constant flight path past the objective area, with the attitude to the aircraft flying abeam the target, employing the site systems of the aircraft. This technique works well in restrictive terrain locations, spurs, and in valleys where the only observation may be right over the target as FOV is obstructed by natural or manmade obstacles.
- **Constant movement between the team.** This allows the team to gain SA of the entire reconnaissance area. A person's natural response is to look up to high ground when they hear the audible sound of an aircraft. Employing one aircraft on high ground and drawing attention of villagers provides the lower aircraft the opportunity to gain observation and movement in and around the objective without drawing attention to it, and still be in position to support when required. In locations where OPs do not provide the best observation, "fly-by" reconnaissance should be employed.

URBAN AREA WITH FLAT TERRAIN

3-465. To gain observation of the target area in this type of environment, it may be necessary to employ the following:

- **Maintain constant orbit around the objective.** This technique provides the team 360-degree observation and affords LOS on different axis of view in and out of the reconnaissance area. Distance between lead and wing aircraft may vary depending upon the size of the area, however as the lead aircraft is conducting a turn looking down a road, alley, or linear area, the wing aircraft can support/backup the FOV from the reverse side. It becomes critical to employ on-board systems augmenting visual cues the aircrew employs to acquire targets. This technique assists in reducing dead space/unobserved area the lead aircraft may not be able to view after passing the location on the ground. It is still the wing aircraft's responsibility to "follow and

support” with suppressive fires or observation at a distance to the lead aircraft with enough reaction time to influence the situation.

- **Alternating a right or left orbit around the objective.** When standoff distance is greater than 1,500 meters, a left orbit is conducted around the reconnaissance area. The copilot employs the on-board site system searching the area in different FOVs and providing reconnaissance information on the objective area with the use of the site system at a standoff distance. When reconnaissance requires the team to move in closer to gain a more detailed picture or support a ground element, the rotation changes around the target to a right orbit. This technique allows the pilot observation on targets at a closer range to employ suppressive fires quickly and guide ground elements on the target. Cross talk between aircrews is important to delineate between what targets are primary and alternate, but the employment of suppressive fires and direct movement for the ground forces at this point becomes largely the responsibility of the pilot in the right or back seat.
- **Conduct observation at a higher vantage point and slower airspeeds.** Recognizing obstacles of an urban flat area and built-up features obstructing FOV, the team has to adapt to the obstructions and gain observation by flying at a higher altitude above the ground and operate at slower airspeeds. Employing these two techniques allows the team to view the ground floor of buildings, roads, or open areas obstructed by some other natural or manmade obstacle. A small row of roadside trees or a two- or three-story building is an obstruction when attempting to gain observation on a location where activity may occur. By increasing the flight path above ground level (AGL), the attack reconnaissance team now has an advantage over unobserved locations. Increasing AGL observation, coupled with reducing airspeed, only increases the amount of time the team can maintain observation of a target.

EMPLOYMENT OF LASERS

3-466. One of the most effective tools assisting ground forces with identification of targets in urban areas is the laser. When employing lasers, the aircrew must use positive verbiage or terms to identify movement to the ground element. Even when a laser spot is seen on a target, all references need to be in cardinal directions for ease of guidance. When giving a clock direction or a variant to a clock direction for guiding techniques to the ground forces, it is imperative to call all movements off the ground element and not the attitude of the aircraft. This is very important when calling directions in an urban environment and can be employed by calling a direction and a certain number of houses/buildings from the ground elements position to a target location. Some techniques used by attack reconnaissance teams in support of ground elements include—

- Air-to-ground laser use.
- Ground-to-ground laser use.

AIR-TO-GROUND LASER USE

3-467. The OH-58D uses an AIM-1 IR marking system normally mounted on the .50 caliber machine gun to provide a direct beam onto a target when viewed under a NVD. If available, an additional AIM-1 laser is placed inside the cockpit for the copilot to use as a marking tool. If available, the AH-64 utilizes the infrared zoom laser illuminator designator (IZLID) laser device attached to the 30-mm gun in the same manner. The copilot has the AIM-1/IZLID on a lanyard, connected to the ALSE vest, and employs it when identifying a target during an air-to-ground walk-on. The AIM-1/IZLID is also used to—

- Identify a target handover.
- Illuminate a location on the ground for relief on station.
- Mark an LZ/PZ for utility helicopters.
- Mark targets for ground forces.

3-468. This technique is also used to guide FW aircraft or ground elements onto a target, and marking with the laser beam reduces the error of identifying targets in congested areas. When working with ground forces, it becomes important to mark ground targets not on ground level, but a little higher so the LOS is

visible to the ground element. What the attack reconnaissance team observes from the air at a higher elevation may not be visible to ground forces because other obstacles obstruct ground-level view.

3-469. Place the “hit spot” of the AIM-1/IZLID higher on a target (third story of a house, top of a building) to allow ground forces to view the target from ground level. This allows them to maneuver into position on a reference point and acquire or search an identified objective. When city lights are intense, the use of the AIM-1 laser is also better identified toward the top of a building when viewed from ground level. A key point for the “walk on” phase of employing the AIM-1/IZLID laser is moving the beam in a zigzag or circular pattern for easier identification by the ground force. This is useful when showing the ground path from the ground unit to the target by moving the laser hit spot in front of the ground elements as they continue to move. The air commander’s laser pointer and PAC-4 laser, mounted on an M-4 carbine, may also be employed from an aircraft.

GROUND-TO-GROUND LASER USE

3-470. Most ground units employ a PAC-4 laser marking system attached to their personal weapons or a commander’s pointer. These lasers are the same style as the AIM-1 in that they are used to mark targets when using NVDs. The ground element can direct movement to a location for target identification or TA to aircrews supporting the ground plan.

SECTION X – QUICK REACTION FORCE OPERATIONS

QUICK REACTION FORCE

3-471. A QRF is any force poised to respond on very short notice. The QRF provides the TF commander an “on call” capability to react to contingencies within the AO. The QRF package is based on anticipated mission requirements and crew and aircraft assets available. Because of the short fused launch order, mission success requires extensive preplanning by QRF aircrews and the supporting operations cell. While reaction time afforded to the QRF is challenging, the actual missions performed are within the ARC’s METL. ARCs are frequently tasked as an element of the QRF, with a main mission of security and reconnaissance. The minimum ARC package consists of two attack reconnaissance aircraft.

3-472. The ARC supports the QRF as a pre-positioned force within the AA, or responds to contingencies via a “change of mission.” When operating as a pre-positioned force, the ARC QRF is expected to support 24 hour coverage or until relieved by the higher headquarters. The ARC commander must plan and allocate resources (aircraft, aircrews, and maintenance support) to execute the tasking.

PRE-POSITIONED QUICK REACTION FORCE

3-473. The standard battalion pre-positioned QRF package includes two attack reconnaissance aircraft, two utility aircraft (UH-60), and ground forces. The parent CAB may also have two UH-60s, a MEDEVAC aircraft and one heavy lift helicopter (CH-47) are on call to support if required. The QRF maintains a readiness condition (REDCON) as established in the OPORD for the duration of the duty period. The standard QRF duty day is 14 hours, allowing for two hours of mission planning and a 12-hour shift. Depending on the number of crews available and the OPTEMPO, the ARC commander, with the TF commander’s approval, may consider a “first up/second up” crew duty/rest model to support the QRF tasking.

3-474. Aircrews assigned as the QRF should not be tasked for additional missions. To reduce risk of aircrew fatigue while assigned to the QRF, the following steps are taken:

- Restrict QRF crewmembers from conducting rigorous physical training while on QRF.
- Afford aircrews the opportunity to sleep during the QRF duty period, if the tactical situation allows.
- Provide the QRF separate environmentally controlled staging area for all crews and personnel.

- Exempt QRF crews from conducting any other additional duties that distract from QRF readiness.
- The TF commander approves training flights during QRF duty period.

PRELAUNCH PLANNING CONSIDERATIONS

3-475. The QRF AMC is the focal point of all coordination between the supporting staff and the QRF. Prior to assuming the mission, the AMC—

- Obtains a tactical update brief and determines the status of the on-duty QRF elements and/or ongoing missions. This action determines the possibility of a relief-in-place or immediate launch.
- Obtains a weather brief for the duration of duty shift plus two hours.
- Files an EPA and flight plan for the entire QRF package. All mission planning except takeoff time, route-of-flight, duration-of-flight, and destination is completed.
- Completes a mission risk assessment and obtains approval from the TF/battalion commander. The mission risk assessment should approve no lower than medium risk operations. Approved operations include all tasks on the crew's CTL, all conditions (day, night, NVD), and all modes of flight that may be encountered during the duty period. The crews are briefed to operate in the worst weather forecasted during the duty period or go/no-go weather is briefed.
- Completes crew mission kneeboard packets for each aircraft providing all known information.
- Conducts an air mission brief with all known information and ensures each aircrew completes applicable crew and passenger briefings.
- Ensures all aircraft, crews, and support personnel assume designated REDCON level. All aircraft are preflighted and individual equipment checks complete prior to assuming mission. Depending on unit SOP and mission, aircraft are run-up with communications checks complete (includes spare aircraft).
- Ensures QRF package maintains REDCON level as briefed until alerted or relieved.
- Conducts static rehearsal of anticipated missions.
- Immediately informs controlling flight operations of any developments that will interfere with QRF launch.

QUICK REACTION FORCE ALERT PROCEDURES

3-476. The battalion or TF commander establishes criteria for launching the QRF so that unnecessary alerts are avoided; however, the QRF is alerted as early as possible. Alert of the QRF normally meets the following criteria:

- The QRF launch authority approves the mission.
- The mission is a "preapproved" immediate response mission.
- The battalion/TF commander determines that alerting the QRF is justified in anticipation of launch approval.

3-477. When alerted, the QRF assumes the designated REDCON as quickly as possible and awaits either a launch order or stand-down order. Specific tasks necessary to assume the mission include—

- QRF AMC reports to the operations center for a mission brief. Crew packets are completed and printed for all aircrews. In some cases, the QRF is ordered to launch immediately and crews proceed with communications cards and products on hand, received during initial QRF brief. The QRF AMC receives and briefs the mission via radio.
- PCs from each aircraft meet the AMC for a mission brief.
- Copilot and crewmembers from each aircraft run-up the auxiliary power unit, if required, and initialize all systems, mission equipment, and weapons. The communications check consists of all copilots checking in with the AMC's copilot when able.
- When the mission brief is complete, each PC reports to their aircraft to complete run-up, brief the crew, and conduct communications check with the AMC.

- Once the QRF package is at the appropriate REDCON level, the AMC reports to the operations center and awaits further instructions.

QUICK REACTION FORCE POST-LAUNCH PROCEDURES

3-478. Once ordered to launch, the AMC or flight lead requests priority handling from the control agency for takeoff and route of flight. This should be precoordinated and is usually based on call sign. As the mission progresses, the AMC updates the operations center and requests any additional follow-on forces. When the mission is complete, the QRF returns to the AA and assumes the designated REDCON level. The AMC reports to the operations center and debriefs the battalion/TF S-2 and/or S-3. Part of the debrief is a QRF status report with information as to how much mission time each crew has remaining and if any crews or aircraft need replacing.

CHANGE OF MISSION

3-479. Change of mission is the most common QRF tasking received by the ARC. Due to the mobility, lethality, and flexibility of the attack reconnaissance teams, change of mission allows the TF commander to task organize assets quickly when responding to contingencies. Change of mission occurs when the ARC is conducting a current tasking and is given a new task and purpose. The higher headquarters issues a FRAGO to the team consisting of the supported unit's call sign, frequency, rally point, command relationship (attached, OPCON, tactical control [TACON]) and a general task and purpose. Typically, the team can expect to execute security, reconnaissance, and CCA when given a change of mission. Once a team receives the change of mission, the AMC contacts the supported unit and provides the following information:

- Call sign of all aircraft.
- Type of aircraft.
- Ordnance status.
- Time on station.
- Any mission restrictions.

3-480. The supported unit in return provides the attack reconnaissance team the following:

- Task.
- Purpose.
- Situational update to include threat activities, friendly forces activities and location, control measures, and any pertinent information necessary to conduct the mission.
- CCA check-in, if applicable.

3-481. Once the team has received planning information from the supported unit, the AMC conducts TLP for team employment and notifies its higher headquarters. Additional resources and support are determined for accomplishment of the mission. If the attack reconnaissance team is supporting aviation elements, coordination is conducted to determine flight formations, routes, movement methods, and actions on the objective. The most preferred method of planning and coordination is face to face with the supported unit.

SECTION XI – PASSAGE OF LINES AND BATTLE HANDOVER

PASSAGE OF LINES

3-482. A passage of lines is an operation in which one force moves through another force's position, without interference, with the intent of moving into or out of contact with the enemy. The battalion can conduct a passage as a part of attack, reconnaissance, security, or air assault operations. There are occasions when other units pass through the battalion's position. Also, the battalion may facilitate another unit's movement by monitoring its progress through PPs and contact points.

- Forward passage is executed during both offensive operations and defensive operations. In the offense, attack reconnaissance aircraft may conduct forward passage to continue an attack;

conduct a penetration, envelopment, or a pursuit; or pass another unit for any reason. In the defense, a forward passage of lines may be conducted as part of a counterattack of one unit through another.

- Lateral passage is conducted in the same manner as forward passage.
- Rearward passage is conducted as part of a retrograde operation or when an aviation or ground unit returns from a cross-FLOT mission.

CONSIDERATIONS

3-483. When a company is the passing force, it is particularly vulnerable because aircraft may be overly concentrated, stationary force fires may be temporarily masked, and the unit passed through may not be properly positioned to react to enemy actions. Reconnaissance and coordination are critical to ensure passage is conducted quickly and smoothly. With aircraft in an overwatch/security position, ground elements can verify friendly and enemy positions with air elements to avoid fratricide.

Control Measures

3-484. Control measures associated with a passage of lines are generally restrictive to prevent fratricide. As a minimum, they include—

- PPs.
- Passage lanes.
- ABF/SBFs.
- BHO line.
- Contact points.
- Routes (air and ground).
- PLs.
- Recognition signals.
- FSCMs.
- AAs.
- HAs.

3-485. The headquarters directing the passage designates or recommends contact points, passage lanes, AAs, routes, and start and end times for the passage. The commander may also use start points, RPs, FSCMs (such as CFLs), and other control measures as necessary to conduct this task.

3-486. Contact points for ground elements should be located along the designated passage PL allowing the passed unit to provide overwatching fires. Contact points normally should be at easily identifiable terrain features, such as road junctions. For terrain without many identifiable terrain features, GPS coordinates are an excellent backup.

Planning

3-487. Timely and specific coordination before passage of lines is essential. The most desirable method is a face-to-face exchange of information. At a minimum, the exchange should include—

- Intelligence information.
- Confirmation of IFF codes.
- Tactical plans.
- SOPs.
- Period of time required for passage.
- Locations of PPs and friendly unit locations.
- Disposition and scheme of maneuver of friendly units.
- Enemy situation in sector, including air activity.
- Types and numbers of aircraft to pass.

- Methods of communication, to include frequencies and call signs, visual signals, and backups.
- Control of friendly supporting fires, including restrictive FS coordination.
- AD weapon control status.
- Friendly minefields and obstacles.
- Contingency plans for stationary and passing units if they are attacked during passage.

3-488. Other considerations include—

- Flight formations.
- Movement techniques.
- Link-up procedures (if multiple PPs are used).
- IFF on/off procedures.
- C2 procedures.

AVIATION SUPPORT OF GROUND UNIT PASSAGE OF LINES

3-489. When one ground unit is conducting a passage of lines through another ground unit, ARCs may support by conducting a reconnaissance of the PPs, initiating and maintaining liaison, or conducting screening or overwatch operations. Attack reconnaissance assets can assist in preparation for a forward passage of lines by reconnaissance of routes to, through, and beyond the area of passage. They also may reconnoiter existing unit locations and proposed positions. Care must be taken not to compromise unit locations and intentions. Attack reconnaissance assets may also assist in a passage of lines by screening between the enemy and the passing force to provide early warning and overwatching fires.

BATTLE HANDOVER

3-490. A BHO is a coordinated operation between two units transferring responsibility for fighting an enemy force from one element to another. The BHO maintains continuity of the combined arms fight and protects the combat potential of both forces. Ground BHOs, such as aircraft passing back through friendly lines, are usually associated with a passage of lines. BHO may occur during offensive or defensive operations.

3-491. BHO is a common ARC operation. It occurs between attack reconnaissance units during relief on station, and between attack reconnaissance units and ground units. The control measures used are simple and standardized. When conducting air and ground operations, air and ground commanders often pass an enemy force in contact to another. BHO governs this process in terms of close coordination, FS, and mutual understanding of responsibilities. No method of communication is better than face-to-face contact. Whenever the situation permits, face-to-face, air-to-ground, and air-to-air linkups between individuals should be made. There are innumerable benefits to landing next to a relieving counterpart, getting out and showing that person, on a map, the specific operational environment situation gathered. ARCs can also assist in BHOs between ground units.

3-492. When conducting a BHO, whether with another air or ground unit, the element conducting the handover must accomplish critical tasks. Tasks associated with a BHO to or from a ground unit include—

- Establishment of communications.
- Contact points.
- Overwatch positions.
- Unit locations using PLs, check points, or other control measures.
- Frequencies.
- Signals and alternates.
- Codes.
- Recognition signals.
- Fire coordination measures.

- Threat situation.
- BDA.

3-493. When conducting a BHO between ARC elements or another attack reconnaissance unit, additional critical information is passed from the unit in contact and the relieving unit. A method/technique for conducting a BHO is the lead of the relieving team links up with and flies trail for the lead of the team being relieved. This technique allows specific points of interest to be evaluated (with laser pointers if applicable) and gives the best SA to the relieving team. Table 3-10 provides voice BHO information. Digital BHO is used in conjunction with voice BHO to provide rapid and accurate information transfer. The unit on station sends information via the IDM to the relieving unit. Table 3-11 provides AH-64D digital BHO information.

Table 3-10. Voice battle handover information

Unit on Station		
Line	Information	Description
1	Description of enemy	Forces and locations
2	ADA	Assets and locations
3	Bypassed locations	Enemy units bypassed
4	Current threat activity	Direction and speed
5	Changes to mission	Received and acknowledged
6	Friendly forces	Location, activity, markings
7	Recommended ABF/SBF/BP	Method of attack (CCM–static)
8	Conditions at ABF/SBF/BP	Dust, smoke, rotor wash
9	CBRN threat	CBRN conditions
10	A2C2 information	Egress route
Relieving Unit		
1	Update FARP/AA information	Current/future location, active FARP
2	A2C2 changes	Routes, active fire control measures
3	Mission changes	Shift active FARP, type of attack, etc.
4	Pertinent issues	Any information not previously passed

Table 3-11. AH-64D Digital battle handover information

Unit on Station	
Line	Information
1	Target and threat files
2	FCR targets
3	Shot at files (BDA)
4	Any No-fire areas
5	Updated waypoints, hazards, and control measures

- 3-494. When a follow-on attack is required, ARC elements conduct BHO in the following format:
- Team lead of relieving unit enters the net of the unit to be relieved. Aircraft locations are passed to the relieving unit.
 - Team leads exchange BHO information.
 - Relieving unit gives ETA to “set” prior to advancing into firing positions.
 - Once in firing positions, relieving unit calls “set”.
 - The unit being relieved breaks station and egresses in a counter-clockwise movement.
 - The unit being relieved calls “handover complete” once all aircraft complete egress.

SECTION XII – AIR COMBAT OPERATIONS

GENERAL

3-495. Deliberate and chance encounters with enemy aircraft may occur throughout the AO. Currently, enemy tactical fighter threat to helicopters is low to moderate. Dissimilar speed, altitude, and maneuvering characteristics offset the likelihood of engagement between the two types of aircraft. Enemy aircraft with look-down, shoot-down radar are potential threats because of their ability to detect and engage flying targets. However, there is no specific indication of potential threat countries training their pilots to engage helicopters nor is there any indication of tactical fighters or interceptors being integrated into the low-level integrated AD.

PLANNING CONSIDERATIONS

3-496. Generally, air combat between Army helicopters and enemy rotary-wing or FW aircraft is not desired. Although the higher headquarters sets the battle space to minimize the probability of undesired aerial encounters, commanders must anticipate the possibility of chance air combat operations and plan accordingly. Priority remains to the assigned mission.

AVOID DETECTION

3-497. During the MDMP, battalion plans the operation to minimize the enemy's ability to detect unit aircraft. Missions are planned to avoid known and suspected enemy locations, if feasible. Appropriate maneuver, terrain masking, cloud cover, obscurants, night operations, and FS help degrade enemy detection capabilities. The TACOPS officer, with the S-2 and S-3, recommends ASE settings to thwart the capabilities of known and suspected threat detection systems.

PROVIDE EARLY WARNING

3-498. The higher headquarters staff coordinates with various intelligence elements, AD units, UAS units, and the airborne warning and control system to provide early warning of enemy aircraft affecting the operation. Appropriate ASE settings, OH-58D thermal imaging system, and AH-64 Longbow Apache's FCR can assist in seeing the enemy first.

PROVIDE FOR SUPPORT

3-499. The higher headquarters staff coordinates for rapid fighter support to protect Army aircraft should they come under air attack

COORDINATING INSTRUCTIONS

3-500. The battalion OPORD should contain the commander's instructions regarding subordinate unit action upon contact with enemy aircraft, if the commander's desires or priorities during the operation vary from the SOP. Actions available to aircrews, in the commonly desired order of preference, are avoid, evade, threaten, or engage threat aircraft.

SECTION XIII – DECEPTION OPERATIONS

3-501. Deception operations most commonly performed by battalions are feint and demonstration. Deception operations are almost always conducted as part of a larger operation.

FEINT

3-502. A feint is a limited attack to divert an enemy's attack or deceive him as to friendly force intentions. Feints are frequently used for deception before or during a main attack. To succeed, a feint must appear to

be the main attack. Additional feints are conducted to cause the enemy to reveal its defensive posture and disrupt its decision making cycle. Feints reduce resistance the main attacking force will encounter by holding enemy units in the feint area.

3-503. ARCs normally attack enemy targets or conduct reconnaissance and security operations in support of ground feints. ARCs perform air route reconnaissance and security for assault units executing false or actual air assault operations in support of the feint. ARCs can also conduct feints independently.

DEMONSTRATION

3-504. A demonstration serves the same purpose as a feint but does not involve contact with the enemy. The objective of a demonstration is to deceive and confuse the enemy as to the real intentions of the attacking force. For a demonstration to succeed, the enemy must observe the demonstrating force's operation and be deceived but not actively engaged by it. The nature of a demonstration allows for the use of decoys, simulations, and tactically inoperable equipment to portray additional strength. Demonstrations also may be used to provide security or conduct reconnaissance to assess enemy reaction.

3-505. ARCs normally provide fires or conduct R&S operations in support of a ground demonstration. ARCs perform air route reconnaissance and security for assault units executing false or actual air assault operations. ARCs can also conduct demonstrations independently.

Chapter 4

Sustainment Operations

This chapter describes maintenance and logistics doctrine. The role of these functions is maintaining and supplying the force during continuous operations. This chapter discusses how to coordinate for different levels of support, and how to request and receive support from the ASB. A thorough understanding of the mission and function is critical to successful aviation logistics and sustainment. See FM 3.04.500 for more information on aviation maintenance and logistics operations.

SECTION I – INTRODUCTION

4-1. Aviation logistics organizations must be designed to place the right logistics resources at the right location at the right time. Aviation logistics organizations primarily consist of an ASB within CABs at division and theater levels and an aviation maintenance company and FSC with each operational aviation battalion. These units collectively form the framework for aviation logistics in the Army's redesigned force structure. The ARB's supply and maintenance support structure is as follows:

- Aviation battalion's HHC.
- Aviation battalion's FSC.
- Aviation battalion's aviation maintenance company.
- CAB's ASB consisting of—
 - Headquarters and support company (HSC).
 - Network support company.
 - Distribution company.
 - Aviation support company (ASC).

Contents	
Section I – Introduction.....	4-1
Section II – Logistics Fundamentals.....	4-1
Section III – Maintenance.....	4-6
Section IV – Battalion Sustainment Units	4-11
Section V – Standard Army Management Information Systems.....	4-20

SECTION II – LOGISTICS FUNDAMENTALS

4-2. It is essential for all leaders, not just logisticians, to understand the fundamentals for supporting military operations. By understanding how the logistician is trained, manned and equipped for sustainment operations, the supported commander will know what to expect. The following paragraphs discuss logistics characteristics and methods of resupply.

LOGISTICS CHARACTERISTICS

4-3. Historically, success in battle is dependent upon unity of effort between the tactical operation and its sustainment operations. The combat commander succeeds or fails by how well the logistics operators in the operational environment understand and adhere to logistics characteristics discussed in FM 4-0. These logistics (sustainment) characteristics are—

- Responsiveness.
- Simplicity.

- Flexibility.
- Attainability.
- Sustainability.
- Survivability.
- Economy.
- Integration.

4-4. In addition, how well the combat commander emphasizes accurate and timely reporting and incorporates logistics leaders into the planning and preparing process prior to execution also impacts upon his success or failure.

METHODS OF DISTRIBUTION

4-5. A company uses voice or digital means to request resupply and report status. The method used is determined after an analysis of the factors of METT-TC. The three distribution methods of resupply are—

- **Supply point distribution.** Supply point distribution requires unit representatives to move to a supply point to pick up their supplies using their organic transportation.
- **Unit distribution.** The ASB may use combat logistics convoys (CLCs) to conduct unit distribution operations. Unit distribution provides delivery of supplies directly to the unit. A unit representative meets the resupply package at the logistics release point (LRP) and guides the package to the battalion or company's position.
- **Throughput distribution.** Shipments bypass one or more echelons in the supply chain and speed delivery forward. Throughput is more responsive to the user, provides more efficient use of transportation assets, and supplies are handled or transloaded less. Throughput is used frequently to resupply FARP operations. Throughput to forward areas leverages configured loads, containerization, information, force structure design, technological enablers, and C2 relationships to deliver sustainment from the operational level directly to the customer or its supporting unit.

SUPPLY OPERATIONS

4-6. The battalion is responsible for coordinating and requisitioning supplies for companies. Although the companies do not have a TOE position for a supply officer, it should be assigned as an additional duty. The assigned supply sergeant assists the 1SG in obtaining and delivering supplies. Some items are handled internally, while coordination is made with the battalion S-4 for transportation assets (internal or external) to deliver bulky items. The commander ultimately establishes priorities for delivery, but supplies and equipment in classes I, III, V, and IX are usually the most critical to successful operations.

4-7. To manage unit supply operations, the supply officer/sergeant uses commander's guidance; authorization documents (TOE/MTOE, hand receipts TMs, and FMs); and external supply SOPs (ASB, aviation maintenance company, and/or FSC). The battalion SOP provides detailed procedures for requesting, receiving, storing, inventorying, issuing, and turning in supplies, equipment, and repairable parts (serviceable and unserviceable).

4-8. Supply operations involve acquisition, management, receipt, storage, and issuance of all classes of supply except class VIII. Army regulation (AR) 710-2, FM 3-04.500, FM 4-0, JP 4-0, JP 4-03, and FM 10-1 contain additional information. See table 4-1, page 4-3, for classes of supply.

Table 4-1. Classes of supply

CLASSES	ITEMS
Class I	Subsistence, including free health and welfare items.
Class II	Clothing, individual equipment, tentage, tool sets and kits, hand-tools, administrative, and housekeeping supplies and equipment (including maps). This also includes items of equipment other than major items, prescribed in authorization/allowance tables and items of supply (not including repair parts).
Class III	Petroleum, oils, and lubricants (POL), petroleum and solid fuels, including bulk and packaged fuels, lubricating oils and lubricants, petroleum specialty products, coal, and related products.
Class IV	Construction materials, including installed equipment, and all fortification/barrier materials.
Class V	Ammunition, of all types (including chemical, radiological, and special weapons), bombs, explosives, mines, detonators, pyrotechnics, missiles, rockets, propellants, and other associated items.
Class VI	Personal demand items (nonmilitary sales items).
Class VII	Major items: A final combination of end products which is ready for its intended use (principal item), such as, aircraft, mobile machine shops, and vehicles.
Class VIII	Medical material, including medical peculiar repair parts.
Class IX/IX(a)	Repair parts and components, including kits, assemblies, and subassemblies, reparable and nonreparable, required for maintenance support of all equipment.
Class X	Material to support nonmilitary programs, such as, agricultural and economic development, not included in classes I through IX.

CLASS I

4-9. The battalion S-4 requests class I supplies automatically on the daily strength report. Class I ration requests are consolidated by the S-4 section staff and forwarded to the CAB S-4 or appropriate support area if operating independently. Extra rations usually are not available at distribution points; therefore, ration requests must accurately reflect personnel present for duty. The CAB S-4 section staff draws rations from the distribution point and issues them to the battalion. Company 1SGs have added responsibility of ensuring all attached, OPCON, and DS elements within their respective AOs are included in the head count.

CLASS II

4-10. The supply officer/sergeant uses unit-level logistics system-logistics staff officer (ULLS-S4) to request class II supplies and equipment; expendable items such as soap, toilet tissue, and insecticide are distributed during LOGPAC operations. Section leaders and/or platoon sergeants submit requests to the supply officer/sergeant, who then must obtain budget approval from the parent organization S-4 before submitting the ULLS-S4. The items are then distributed to the battalion using supply point distribution. In some cases, the items may be throughput from division or theater to subordinate battalions.

CLASS III

4-11. Units normally use fuel forecasts to determine bulk POL requirements. The company 1SG submits requests for POL to the parent organization S-4. Battalions consolidate company forecasts and estimate amount of fuel required based on projected operations, usually for the period covering 72 hours beyond the next day. Battalion S-4s forward requests through brigade S-4 to the appropriate material management center (MMC). Fuel trucks from the ASB return to battalion areas either as a part of the LOGPACs or to refueling points in FARPs.

4-12. Class III bulk for the CAB is delivered by division or corps sustainment brigade assets. The division sustainment brigade can store a one-day supply of class III bulk. The fuel is stored and distributed from collapsible bladders or 5,000-gallon tanker trailers. Class III bulk normally is delivered to the ASB, and

routinely delivered by the sustainment brigade as far forward as the aviation brigade support area (BSA). However, it may be delivered as far forward as battalion FARPs in certain situations.

CLASS IV

4-13. Battalions usually need these items for fighting positions, perimeter defense, and access points. Commanders should ensure the SOP specifies vehicle loads for each item. The company supply officer/sergeant requests class IV items using ULLS-S4.

CLASS V

4-14. Normally, the S-4 requests ammunition from the appropriate MMC. Ammunition managers use combat loads rather than days of supply (DOS). Combat loads measure the amount of class V a unit can carry into combat on its weapons system. Once the request has been authenticated, the ammunition is distributed to the battalion FSC by the ASB's distribution company.

Required Supply Rate

4-15. Required supply rate (RSR) is the estimated amount of ammunition needed to sustain the operations of a combat force without restrictions for a specific period. RSR is expressed in rounds per weapon per day and is used to state ammunition requirements. The battalion S-3, in conjunction with the S-4, normally formulates the battalion RSR, although it is often adjusted by higher headquarters.

Controlled Supply Rate

4-16. Controlled supply rate (CSR) is the rate of ammunition consumption (expressed in rounds per day per unit, weapon system, or individual) supported for a given period. It is based on ammunition availability, storage facilities, and transportation capabilities. A unit may not exceed its CSR for ammunition without authority from higher headquarters. The battalion S-4 compares the CSR against the RSR; then remedies shortages by requesting more ammunition, suballocating ammunition, cross-leveling, or prioritizing support to subordinate units. The battalion commander establishes CSRs for subordinate units; the company commander ensures company requirements are anticipated, requested and received.

Basic Load

4-17. Basic load is the quantity of ammunition authorized by the theater commander for wartime purposes and is required to be carried into combat by a unit. The basic load provides the unit with enough ammunition to sustain itself in combat until the unit can be resupplied. The unit basic load (UBL) may not be the appropriate load to conduct operations based upon contingencies. Any deviation from the UBL is requested early for approval and resourcing.

Combat Load

4-18. Combat load is the quantity of supplies, such as fuel or ammunition, carried by the combat system or Soldier into combat. The commander knows the required combat load for each system and Soldier per individual mission requirement.

CLASS VI

4-19. Class VI supplies are made available through local procurement, transfer from theater stocks, or requisitioning from the Army and Air Force Exchange Service. When a post exchange is not available, the S-1 is responsible for overseeing and submitting class VI requests.

CLASS VII

4-20. Class VII items are controlled through command channels and managed by the supporting MMC. Each echelon manages requisition, distribution, maintenance, and disposal of these items ensuring visibility

and operational readiness. Units report losses of major items through both supply and command channels. Replacement requires coordination among materiel managers, class VII supply units, transporters, maintenance elements, and personnel managers. Class VII items are issued based on battle loss reports a company submits to its parent organization S-4. Each battalion should have a property book officer (PBO) to account for these items, any stay behind equipment, or other theater issued stock items received in the theater of operations.

CLASS IX AND CLASS IX (A)

4-21. Class IX supplies include repair parts and documents required for equipment maintenance operations. When a company orders repair parts, the platoon sergeant (ground components) and material manager/tech supply (air components) coordinate with the FSC supporting the specific requests. The company also obtains repair parts by exchanging repairable parts, including batteries, for NVDs and manportable radios.

4-22. Class IX requisition begins with the unit filling requisitions from its combat spares. If the item is not stocked on the combat spares or is at zero balance, the requisition is passed to the supply support activity (SSA). This SSA fills the request from its authorized stock lists (ASLs) or passes the requisition to the MMC. The ground maintenance sections of ASBs normally maintain the class IX ASLs for ground equipment. The ASC maintains the class IX (A) combat spares.

CLASS X

4-23. Division level or higher provides instructions for request and issue of class X supplies.

MAPS

4-24. Unit personnel submit requests for unclassified maps to battalion S-4, and requests for classified maps through battalion S-2. If a digital topographic support system team is attached, personnel may also make customized AO maps upon request to the main CP.

SUPPORT BY HOST NATION

4-25. Logistics support and transportation may be provided by host nation organizations and facilities. Common classes of supply may be available and obtained from local civilian sources. Items may include barrier and construction materials, fuel for vehicles, and some food and medical supplies. Requisition and distribution are coordinated through logistics and liaison channels.

SUSTAINMENT DURING COMBAT OPERATIONS

4-26. Sustainment operations are inseparable from decisive and shaping operations. Failure to sustain may result in mission failure. Sustainment operations occur throughout the AO, not just within the rear area or noncontiguous support areas. Sustaining operations determines how fast forces reconstitute and how far forces can exploit success. At the tactical level, sustaining operations establish the tempo of the overall operation.

4-27. Aviation logistics units should be trained, equipped and manned to operate in a hostile environment while accomplishing their mission. The aviation unit commander must consider what level of force protection his unit can accomplish while still performing sustainment and support operations; for example, destroy level I, defeat level II with assistance, and employment of a tactical combat force (TCF) for level III (appendix A). This does not presume that 100 percent level of sustainment operations can occur 100 percent of the time. Sustainment may fluctuate depending upon the threat level and enemy operations. If the enemy threat is stronger than the ability of the aviation logistics unit to destroy or defeat, then the prudent commander knows other forces are required to sustain logistics operations at the level desired or risk their destruction.

4-28. Aviation logistics leaders must understand the concepts of battle command as discussed in chapter 2 of this manual. This requires logistics Soldiers gain and sustain competency in executing individual and collective level combat tasks required for their unit and its associated operational environment.

4-29. Maneuver commanders must be willing to allocate combat power as an essential part of the sustainment mission. This allows maneuver forces to defend high risk aviation logistics units and open and maintain as necessary ground and aerial lines of communication. This may take the form of combat unit(s) escorting CLCs, attaching a combat unit to reinforce the perimeter defense or occupying an area with sufficient force for a stated period of time to eliminate an air or ground threat.

4-30. The implied task for the aviation unit commander is possessing the requisite skills necessary to integrate the maneuver commander's forces into his security plan. All logistics leaders must also be capable of defending an assigned AO by employing organic assets. As appropriate, the aviation logistics commander should coordinate with the CAB or battalion S-3 for assistance in development of the area defense plan.

SECTION III – MAINTENANCE

PRINCIPLES

FUNDAMENTALS

4-31. Maintenance is a combat multiplier. When enemy forces have relative parity in numbers and quality of equipment, the force combining skillful use of equipment with an effective maintenance system has a decisive advantage. This force has an initial advantage in that it enters battle with equipment that is likely to remain operational longer. A subsequent advantage is it can repair damaged equipment, make it operational and return the equipment to the battle faster.

4-32. Well-trained and equipped forward maintenance elements are critical to the success of the maintenance concept. They must have the proper personnel, equipment, tools, and immediate access to high usage replacement parts. Field maintenance units concentrate on rapid turnaround of equipment to the battle, while sustainment-level maintenance units repair and return equipment to the supply system.

4-33. The maintenance system is organized around forward support. All damaged or malfunctioning equipment should be repaired onsite or as close to site as possible.

SUPPORT SYSTEM STRUCTURE

4-34. The maintenance support system is a two-level structure—field maintenance and sustainment maintenance.

Field Maintenance

4-35. Field maintenance is performed by aviation brigade personnel assigned to flight companies, aviation maintenance companies and ASCs. The aviation maneuver battalion's assigned flight companies perform authorized maintenance procedures within their capability. Aviation maintenance companies assigned to aviation maneuver battalions provide maintenance support to all flight companies. As compared to the ASC, operational flight battalions are more agile, flexible, and mobile because they have reduced sets, kits, outfits, and special tools (SKOT).

4-36. Both the aviation maintenance company and the ASC perform field-level maintenance; however, the aviation maintenance company is limited to unit maintenance while the ASC is equipped with additional SKOT and is authorized to perform intermediate maintenance. On a case-by-case basis, the aviation brigade may obtain specialized repair authorization from Aviation and Missile Command (AMCOM) to perform limited depot repairs on specific equipment classified as depot level according to the maintenance allocation chart (MAC).

Sustainment Maintenance

4-37. According to FM 4-0, sustainment maintenance is the Army's strategic support. The strategic support base is the backbone of the National Maintenance Program (NMP) and the sustainment maintenance system. At this level, maintenance supports the supply system by economically repairing or overhauling components. Maintenance management concentrates on identifying the needs of the Army supply system and developing programs to meet the supply system demands.

4-38. Sustainment maintenance support is divided and primarily performed by three separate entities—the original equipment manufacturers and their contract field service representatives; Army depots, located at fixed bases in the CONUS; and by the NMP sources of repair.

4-39. Figure 4-1 shows a graphic depiction of two-level maintenance, which illustrates the supported and supporting relationships of field to sustainment maintenance.

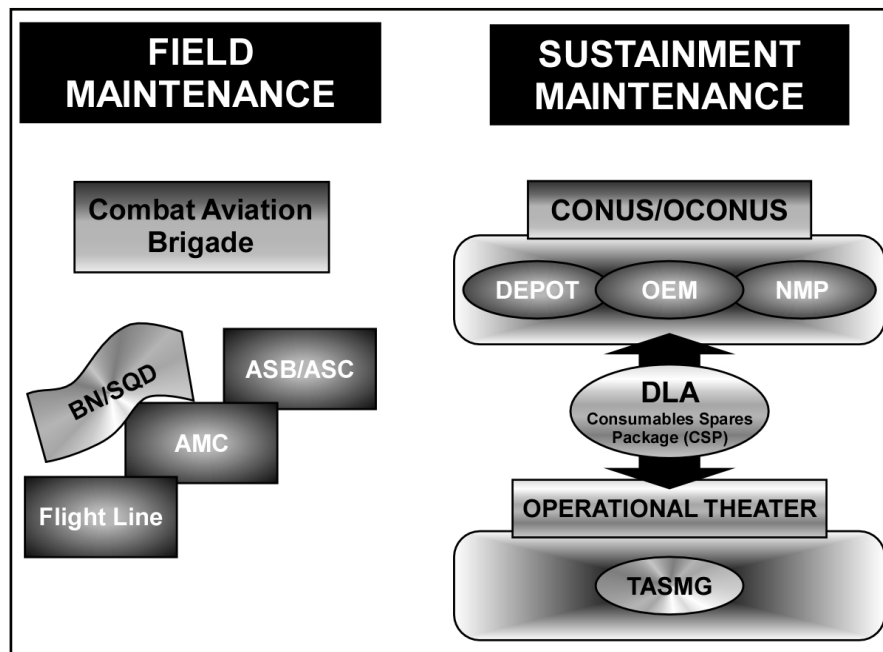

Figure 4-1. Two-level aviation maintenance and sustainment

AVIATION MAINTENANCE OPERATIONS

4-40. As Army aviation transforms, the aviation maintenance company within each battalion will continue to provide unit maintenance above the capability of the flight companies. The ASC assigned to the ASB will continue to provide primarily intermediate maintenance and secondary backup unit maintenance to the CAB's battalions.

4-41. Aviation maintenance is performed on a 24-hour basis. Again, the governing concept is to replace forward and repair rearward so units can rapidly return aircraft for operational needs. Emphasis is on component replacement rather than repair. Such replacement requires increased stockage of line replaceable units (LRUs) and quick change assemblies. Damaged or inoperable aircraft requiring time-consuming repair actions are handled in more secure areas toward the rear. FM 3-04.500 provides more detail.

MANAGEMENT BALANCE

4-42. The flying hour program and operational readiness rates must be balanced ensuring bank hours (hours remaining per aircraft till phase) are available to meet the operational needs required during a

deployment and/or training. Commanders and maintenance officers evaluate available resources and adjust them accordingly. The problem, plan, people, parts, time, and tools (P4T2) concept may assist in this evaluation. Another tool available to commanders and maintenance officers for managing aircraft maintenance is the flowchart.

Flowchart

4-43. The flowchart is a simple, but effective, method that maintenance officers use. Unit-level logistics system-aviation (ULLS-A) provides a flowchart outlining bank time to assist maintenance managers in scheduling maintenance. The flowchart–

- Prevents an unnecessary backlog of scheduled maintenance inspections under normal conditions.
- Prevents a corresponding sudden surge in requirements for aircraft parts.
- Allows the unit maintenance officer a degree of control over individual aircraft hours flown.
- Provides a graphic depiction of future scheduled maintenance requirements.

Operational Readiness Rate

4-44. The ability of an aviation unit to perform its wartime mission is numerically represented by its aircraft operational readiness rate. Higher operational readiness rates are a direct result of effective maintenance and logistics management by all aviation maintenance leaders, officers, and technicians. Reducing aircraft downtime proportionally increases aircraft availability providing the battalion commander with needed aircraft to continue and win the fight (see FM 3-04.500).

SCHEDULED MAINTENANCE

4-45. Scheduled maintenance takes place anytime an aircraft phase, progressive phase management (PPM), and preventive maintenance services to include scheduled component replacement are to be conducted. To ensure minimum disruption to the supported unit's mission (training/tactical), a scheduling system that promotes efficient workflow is needed. This ensures customers receive their aircraft with the least possible delay. Many factors must be considered when production control develops a scheduling system. These factors may include the current workloads and priorities of the supported units, the availability of tools, and the supply of major components, parts, and hardware.

PHASE AND PROGRESSIVE PHASE MAINTENANCE

4-46. The modular force is changing the levels of responsibility and management of phase/periodic maintenance scheduling and flow. A methodical and purposeful flow of aircraft scheduled maintenance events increases overall readiness.

4-47. Ongoing operations, training exercises, and deployments can have a major impact on readiness (for example, flying too many aircraft into scheduled maintenance at a critical time), deployments, training, and availability of resources (tools, maintenance personnel, repair parts, special equipment) must be considered when planning phase maintenance (AH-64) and PPM (OH-58D) inspections.

UNSCHEDULED MAINTENANCE

4-48. Aircraft scheduled for daily mission (training/tactical) requirements may on occasions experience unexpected malfunction, premature component breakdown, or battlefield damage, causing the aircraft to undergo unscheduled maintenance (reactive). Unplanned aircraft system, subsystem, or components malfunctions or breakdowns will prompt production control to coordinate for unscheduled (reactive) maintenance to bring affected aircraft to a fully mission capable status. It is the production control officer's responsibility to prioritize, manage, and track, unscheduled repairs having a negative effect on the total mission capability of the ARB. Maintenance platoon leadership is ultimately responsible for conducting maintenance repairs to affected aircraft systems, subsystems, and components according to established maintenance publications and references.

DEFERRED MAINTENANCE

4-49. When the production control officer is prioritizing maintenance actions, he weighs maintenance actions in terms of what maintenance procedures must be performed immediately, and which maintenance procedures can be postponed for a later time. When maintenance procedures are postponed, this action is commonly referred to as deferred maintenance. Deferred maintenance actions must be performed at a time when an aircraft goes down for unscheduled maintenance or an airframe is scheduled for a preventive maintenance service or phase. Regardless, deferred maintenance actions cannot be delayed indefinitely; it must be coordinated and scheduled to be performed at the earliest opportunity. The commander is the approval authority for all deferred maintenance actions and should be notified immediately when the status of aircraft flightworthiness changes.

AIRCRAFT RECOVERY, EVACUATION, AND BATTLE DAMAGE ASSESSMENT AND REPAIR

Battlefield Management of Damaged Aircraft

4-50. Battle damage assessment and repair (BDAR)/recovery operations are normally planned and coordinated in conjunction with PR operations. Recovery operations move an aircraft system or component from the battlefield to a maintenance facility. Recovery may require on-site repair for a one-time flight, or movement by another aircraft or surface vehicle. In extreme circumstances, only portions of inoperative aircraft may be recovered. An aircraft is cannibalized at a field site only when the combat situation and aircraft condition are such that the aircraft would otherwise be lost to enemy forces. See FM 3-04.500 and FM 3-04.513 for more detailed information on aircraft recovery.

Responsibility

4-51. The battalion is responsible for coordinating aircraft recovery; the aviation maintenance company is responsible for conducting the recovery. A successful recovery operation is a highly coordinated effort between the owning organization, its ASB support, other supporting units, and ground element where the operation is to take place. If recovery is beyond the aviation maintenance company team's capability, ASB support is requested. Overall, control of recovery rests with the CAB CP.

Recovery Teams

4-52. Aviation battalions prepare for aircraft recovery contingencies by designating a DART. The DART, at a minimum, includes a MP, maintenance/shop platoon personnel, aircraft assessor, and technical inspector. The technical inspector may also be the assessor. All members must be trained to prepare aircraft for recovery as this is a unit responsibility. The team chief ensures rigging equipment and quick-fix BDAR kits (tools, hardware, POL products, repair parts, and TMs) are kept ready for short-notice recovery missions. Aircraft recovery can turn into PR if the tactical situation changes; recovery teams are integrated into the QRF. FM 3-04.513 contains a sample aircraft recovery and evacuation SOP.

Planning Considerations

4-53. Assessment of the following factors facilitates selection of the best COA:

- Location of downed aircraft.
- Types of special equipment packages installed on aircraft.
- Amount of damage to aircraft.
- Weapon munitions onboard the aircraft and requirement for explosive ordnance disposal (EOD).
- Tactical situation and proximity to enemy.
- Time available (planning time for aviation maintenance company preparation and rigging is 30 to 60 minutes, which may vary based on METT-TC).
- Weather.
- P4T2.

Courses of Action

4-54. The unit SOP provides guidance required to determine which of the following actions is appropriate for the situation:

- Make combat repairs, defer further maintenance, or return aircraft to service.
- Make repairs for one-time flight and fly aircraft to an appropriate maintenance area.
- Rig aircraft for recovery (by ground or air) and arrange for transport.
- Selectively conduct controlled exchange, destroy, or abandon aircraft in accordance with TM 750-244-1-5 and unit SOP.

4-55. General procedures are typically covered in unit SOPs. FM 3-04.513 provides detailed procedures for preparing and performing recovery operations for specific aircraft. FM 1-120 provides doctrinal guidance on requirements, procedures, and C2 tasks involved in planning, coordinating, and executing airspace control functions. Unless a battalion has attached or assigned UH-60s or CH-47s, it will have to request them to conduct an aerial recovery. Parallel planning using P4T2 for a ground recovery should occur while any aerial recovery operation is ongoing.

Planning

4-56. Recovery operations and, to a lesser degree, maintenance evacuations, can easily be detected and attacked by enemy forces. Units must plan command, control, and coordination for recovery operations in advance. Recovery and evacuation procedures must be included in unit SOPs, contingency plans, OPORDs, and AMBs.

Aircrew

4-57. Depending on the enemy situation, status of the crew, and aircraft communications, the following items or additional pertinent information will be obtained from the pilot or aircraft operator:

- Aircraft mission design series and tail number.
- Crew status and condition (are they able to conduct evacuation of aircraft).
- Describe extent of damage (is aircraft airworthy).
- Enemy activity.
- Aircraft altitude when it went down.
- Approximate fuel remaining in aircraft.
- Pilot-reported weather.
- Time and place of last-known position.
- Heading since last-known position.
- Airspeed when aircraft went down.
- Navigation equipment capability.
- NAVAID signals received.
- Visible landmarks.
- Number of people on board.
- Point of departure and destination.
- Emergency equipment on hand.
- Weapons available, if any.

Destruction of Aircraft and Associated Equipment

4-58. Destruction of aircraft and associated equipment that cannot be recovered and are in danger of enemy capture may be destroyed according to TM 750 244-1-5. The authority for destruction will be delineated and included in SOPs and OPORDs. If possible, aircraft are cannibalized before destruction. The higher headquarters command assigned to a theater of operations, on a mission basis, mandates

recovery and evacuation of enemy, allied, and other United States services' aircraft using higher-echelon assets.

VEHICLE AND GROUND EQUIPMENT MAINTENANCE AND RECOVERY OPERATIONS

MAINTENANCE SUPPORT STRUCTURE

4-59. Ground maintenance support for each battalion is provided by their organic FSC. Sustainment level units provide maintenance assistance as required.

PREVENTIVE MAINTENANCE CHECKS AND SERVICES

4-60. The operator or crew and organizational maintenance personnel perform unit maintenance including scheduled and unscheduled unit-level maintenance, repair, and PMCS. PMCS maintains operational readiness of equipment through preventive maintenance and early diagnosis of problems.

FIELD MAINTENANCE

4-61. Field maintenance units are tailored to the weapons systems of the supported unit and provide the organizational and DS levels of maintenance with a multicapable mechanic. They provide extensive maintenance expertise, component replacement, and limited component repair.

SUSTAINMENT MAINTENANCE

4-62. Sustainment maintenance is characterized by extensive component repair capability. It repairs damaged systems for issue through the supply system as class II, VII, or IX items. This level of maintenance is normally found at theater or depot level.

VEHICLE AND EQUIPMENT RECOVERY PROCEDURES

4-63. The recovery manager coordinates recovery operations with overall repair effort to best support the commander's priorities and tactical situation. FM 4-30.31 describes technical aspects of vehicle recovery operations.

4-64. When the unit recovers its equipment, but lacks the physical means to recover an item, it requests assistance from the supporting maintenance element. Management of recovery operations is centralized at battalion whenever possible.

4-65. Maintenance personnel repair equipment as far forward as possible within limits of the tactical situation, amount of damage, and available resources. Recovery vehicles return equipment to the rear no further than necessary, usually to the maintenance collection point of the supporting maintenance unit.

4-66. Recovery missions interfering with combat operations, or compromising security, are coordinated with the tactical commander.

SECTION IV – BATTALION SUSTAINMENT UNITS

FLIGHT COMPANY

4-67. Flight line or company maintenance activities primarily maintain Army aircraft by conducting scheduled maintenance. Unscheduled maintenance is conducted within the unit's capability. Strict and disciplined company operations allow assigned aircraft to be maintained according to prescribed policies and procedures. An atmosphere of pride of ownership enhances the quality and standard of assigned company aircraft and improves overall unit readiness.

4-68. Crew chiefs perform aircraft launch and recovery operations, and maintain aircraft logbooks in accordance with Army guidance and unit SOPs. They perform both scheduled and unscheduled unit maintenance to include replacement of major subsystem components, maintenance operational checks, and main and tail rotor vibration analysis. Battalion flight companies receive back-up support from the aviation maintenance company to perform both scheduled and unscheduled maintenance.

4-69. Leaders must strictly adhere to established standards and maintenance procedures. The assigned flight crews must conduct detailed preflight and postflight inspections according to the applicable TMs. The crew must ensure that all identified deficiencies and malfunctions are promptly and accurately entered into the aircraft logbook.

AVIATION MAINTENANCE COMPANY

4-70. The aviation maintenance company is organic to attack reconnaissance battalions assigned to CABs. The aviation maintenance company in an ARB comprises of three modular aviation maintenance platoons—the headquarters platoon, the ARP, and the CRP.

4-71. The purpose of the aviation maintenance company is to provide field level maintenance to enable CAB aircraft sustain aviation combat power. The aviation maintenance company is organized to provide quick, responsive, internal maintenance support and repair within its capability and in accordance with the MAC. The aviation maintenance company troubleshoots airframe and component malfunctions and performs maintenance and repair actions. It conducts BDAR and recovery operations within its capability and is assisted by the ASC.

4-72. The aviation maintenance company provides mobile, responsive BDAR and DART operations support through forward maintenance teams (FMTs). FMTs repair aircraft onsite or prepare them for evacuation. The aviation maintenance company commander and production control officer coordinate and schedule maintenance at forward locations of the battalion. The members of the forward element must be able to diagnose aircraft damage or serviceability rapidly and accurately. FMT operations follow these principles:

- Teams may be used for aircraft, component, avionics, or armament repair.
- When the time and situation allow, teams repair on site rather than evacuate aircraft; this includes BDAR.
- Teams must be 100 percent mobile and transported by the fastest means available (usually by helicopter).
- Teams sent forward may be oriented and equipped for special tasks to include recovery operations; type of aircraft recovery will depend on the assets available.

4-73. In some situations, normal maintenance procedures must be expedited to meet operational objectives. In such cases, the unit commander may authorize the use of aircraft combat maintenance and BDAR procedures. Aircraft combat maintenance and BDAR are an aviation maintenance company responsibility with backup from supporting ASC units.

4-74. The BDAR concept uses specialized assessment criteria, repair kits, and trained personnel to return damaged aircraft to the battle as soon as possible. Often, these repairs are only temporary. Permanent repairs may be required when the tactical situation permits. This method is used to meet operational needs. It is not used when the situation allows application of standard methods.

HEADQUARTERS PLATOON

4-75. The headquarters platoon contains a headquarters section, production control section, QA sections and technical supply section. This platoon provides for internal management and quality of repairs, and logistics support within the battalion. The technical supply section operates logistics standard Army management information system (STAMIS), requisitions class IX (Air) spares and manages the battalion prescribed load list (PLL). Oversight is provided by the battalion aviation material officer (AMO) assigned to the S-4 section.

AIRFRAME REPAIR PLATOON

4-76. ARPs assigned to an aviation maintenance company provide their supported aviation units with scheduled and unscheduled maintenance support. Primary responsibility for unscheduled maintenance falls on the owning unit. However, when unit OPTEMPO increases, unscheduled maintenance support can be coordinated and requested through the aviation maintenance company production control office. If the line company cannot complete the unscheduled maintenance in one day or less, it should contact the production control office and request ARP maintenance support. Location of the maintenance action can then be further coordinated by the line company and the production control section. Primary responsibility for periodic scheduled maintenance falls upon the owning unit. Prolonged scheduled maintenance—to include aircraft phases, compliance with recently published aviation safety advisory messages (ASAMs)/technical bulletin (TBs)—can lead a supported unit to request maintenance support from the aviation maintenance company. Maintenance support can be coordinated and requested by the owning unit through the production control office.

COMPONENT REPAIR PLATOON

4-77. The CRP is assigned a headquarters section, shops section, and a systems repair section. The CRP contains assigned aviation repair specialty military occupational specialties (MOSs) to include avionics, armament, powerplant/powertrain, hydraulics, pneumatics, and sheet metal repair assets. The CRP diagnoses airframe and component malfunctions and performs maintenance, repair actions, and removes and installs LRUs within its capabilities.

4-78. The shops section contains an armament/avionics/electrical repair teams. The armament team is responsible for troubleshooting and repairing armament systems, subsystems, and components. Personnel assigned to the armament systems repair team conduct preventive maintenance and conduct testing and troubleshooting of aircraft weapons systems and subsystems. These personnel also perform cleaning, servicing, and ammunition loading and unloading of weapons systems to include configuration changes. The armament team is also responsible for repairing and replacing weapons platforms components in accordance with applicable publications.

4-79. The CRP systems repair section performs preventive maintenance of aircraft components and structures that require specialized technical skills. In addition, maintainers assigned to this section perform scheduled and unscheduled maintenance, troubleshoot faulty components, remove and replace aircraft components, perform BDAR procedures and manage assigned sets, kits, and outfits (SKO) at the platoon level, and provide mission support to flight companies.

FORWARD SUPPORT COMPANY

4-80. An FSC is assigned to each operational aviation battalion and consists of a headquarters section, distribution platoon, and ground maintenance platoon (see chapter 1 for organizational structure). The FSC commander provides all logistics (less medical) to the aviation battalion and is the senior multifunctional logistician at aviation battalion level. The FSC is designed to provide ground, air, missile, and AGSE systems support; refueling and rearming support; and necessary logistics support. The FSC also coordinates with the ASB for additional logistics as required. Each of the FARPs can be task organized to support continuous operations by providing support for maintenance, armament, and rearming and refueling. The FSC also maintains two DOSs of class I, provides field feeding and distribution support, maintains class IX (ground) repair parts and conducts ground maintenance, while maintaining one combat load of class III (Bulk) and class V for its supported battalion. See FMI 4-90.1 for more information on FSC operations.

HEADQUARTERS PLATOON

4-81. The headquarters platoon of the FSC consists of the headquarters section and the field feeding section.

Headquarters Section

4-82. The headquarters section of the FSC provides C2 to assigned and attached personnel. It ensures that subordinate elements follow the policies and procedures prescribed by the FSC commander and the battalion commander. It directs the operations of its subordinate sections as well as the overall logistics operations, less medical, in support of the battalion.

Field Feeding Section

4-83. The field feeding section is found in the FSC of each aviation battalion. The field feeding section provides class I food service and preparation (from the BSA) for the battalion. This section can prepare hot meals and distributes prepackaged or prepared food, or both, from the BSA. It can provide one “heat-and-serve” meal and one “cook-prepared” (A or B ration) meal per day.

DISTRIBUTION PLATOON

4-84. The key activity of the distribution platoon is the conduct of LOGPAC operations to the battalion and getting replenishment sustainment stocks from sustainment brigade units. The distribution platoon also provides supply and transportation support to the battalion. The distribution platoon provides class II, III (Packaged and Bulk), IV, V, VI, and VII to the battalion. The distribution platoon has the ability to conduct simultaneous class III and V retail support to the companies and HHC. The distribution platoon operates FBCB2 and the STAMIS to support supplies ordering and receipt.

Forward Arming and Refueling Point Operations

4-85. The FSC commander is responsible for accomplishing the FARP mission. He assists the S-3 in formulating the FARP plan and coordinates fuel and ammunition requirements with the S-4. The FSC commander request additional FARP support from the ASB. The increased tempo of operations and/or density of traffic may require ATS assets. The FSC commander may request a tactical aviation control team from the general support (GS) aviation battalion ATS company to perform this mission. In addition, a SO certifies the FARP prior to use. If a SO is not available, a pilot of the first aircraft in the FARP certifies the FARP according to the FARP checklist in the unit SOP. See FM 3-04.104 for more information on FARP operations.

4-86. The FSC must be prepared to sustain the ARB with fuel and ammunition during all missions. The success of the ARB mission is directly related to the effectiveness of the FARP and the personnel who run it. This success depends on planning and coordination before FARP operations begin. The ARB normally utilizes four types of FARPs—active, silent, jump, and rolling.

Active

4-87. The active FARP is normally located in the main battle area closer to the area where operations are being conducted. It provides fuel and ammunition necessary for the employment of ARB units during conduct of missions. The active FARP conducts refueling and rearming operations and permits to rapidly refuel and rearm simultaneously.

Silent

4-88. For longer missions, ARBs employ a FARP with additional displaced FARPs (called silent FARPs until activated) waiting to assume the mission at preplanned times or DPs. The silent FARP has all equipment and personnel at the future site, but it is not operational.

Jump

4-89. A jump FARP may be necessary if the enemy occupies LOCs in the AO. Air-emplaced jump FARPs support limited resupply behind enemy lines; the jump FARP is employed for a special mission. It is composed of a forward area refueling equipment (FARE), 500-gallon collapsible fuel drums, and/or ammunition (as the mission dictates). The jump FARP is transported and emplaced by ground or air and

employed when dictated by time or geographical constraints. It allows the uninterrupted support of ARB elements during FARP relocation and resupply.

Rolling

4-90. The rolling FARP allows aircraft providing convoy security for fuel tankers, ammunition, supplies, and FARP movement to refuel and or rearm at the convoy's location. This minimizes the compromising of security by reducing the travel times associated with returning to the FARP. If time allows, a map reconnaissance of the route should be conducted.

Forward Arming and Refueling Point Location

4-91. The FARP location is METT-TC dependent and a function of the battalion S-3. The FARP should be located as close to the AO as the tactical situation permits. The intent is to reduce the distance or time traveled for the aircraft, thereby increasing aircraft time on station while simultaneously striking a balance that exposes the FARP to the least possible risk. The ARB's ability to move quickly also requires that the FARP be able to move quickly to maintain support.

4-92. Commanders can employ and configure their assets as the mission dictates to complete the mission requirements. The commander can choose to have one large FARP or several small FARPs. The ARB can employ three FARPs under the modular design (three sections of class III and three sections of armament personnel). Also, the ARB can be augmented by the ASB and the use of Fat Cow (extended range fuel system [ERFS]/ERFS II) and Fat Hawk/Wet Hawk operations to enhance class III/V requirements. In most other circumstances, aircraft could rearm and refuel at FARPs within the close area. If a FARP must be located behind enemy lines, the following factors should be considered:

- The composition of the FARP should be austere.
- Security will be limited because the FARP will be emplaced for a very short time.
- A thorough map reconnaissance and intelligence update must be accomplished for the area.

4-93. The FARP is located as close to the AO as the tactical situation permits. It is usually located as far forward as 18 to 25 kilometers (METT-TC dependent) behind the FLOT. This distance increases aircraft time on station by reducing the travel times associated with refueling. If possible, the FARP is kept outside the threat of medium-range artillery. Movement and resupply of the FARP are conducted by ground or aerial means. The FARP should remain in one location for only 3 to 6 hours; however, these times may be reduced by the factors of METT-TC. The size of the FARP will depend on the number of aircraft that will use the FARP and the type of refueling equipment (FARE/advanced FARE system or heavy expanded mobility tactical truck [HEMTT]) that is available. Four to eight refueling points are normally sufficient for continuous mission sustainment.

4-94. Ammunition palletized load system (PLS) trucks with mission-configured loads push supplies down to the close area where FARP elements meet them at LRPs. When possible, the FSC commander coordinates for direct delivery to the silent FARP to avoid transloading. Units travel to supply points for fuel or receive throughput from higher echelon 5,000-gallon tankers for transloading.

4-95. The ARB usually emplaces a FARP using its combat trains. At this site, rearming and refueling operations take place for a specific mission. When that mission is complete, the air assets transition to the fixed FARP site in the rear to reconfigure ammunition loads, refuel, and perform required maintenance in preparation for other missions.

GROUND MAINTENANCE PLATOON

4-96. The ground maintenance platoon is organic to the FSC of each aviation battalion. Field maintenance units are tailored to weapons systems of the supported unit, providing maintenance expertise for component replacement and limited component repair.

4-97. The FSC's maintenance platoon provides field maintenance to itself and its battalion. The platoon consists of a headquarters section, maintenance control section, recovery section, maintenance and service

section, and the FMTs. The maintenance platoon provides C2 and reinforcing maintenance to the FMTs. The FMTs provide field maintenance and BDAR to the companies. The platoon maintains a limited quantity of combat spares (PLL, shop and bench stock) in the maneuver control system (MCS). The maintenance platoon's supply section is capable of providing class IX support (combat spares) to each company and the HHC. It also provides exchange of repairable items.

HEADQUARTERS AND HEADQUARTERS COMPANY

GENERAL

4-98. The HHC supports a higher headquarters commander and his staff. It provides personnel and equipment for C2 functions of battalion, and security and defense of the CP. The HHC also provides unit-level personnel service, UMT and logistics and CBRN support.

ORGANIZATION

4-99. Organization and capabilities of the battalion HHC are two of the most important factors in determining how the HHC supports its respective organizations. Force transformation restructured composition of the HHC by eliminating most sustainment assets except for the medical treatment team. With the new HHC organization, remaining sustainment assets are now part of the ASB and FSC.

4-100. The typical aviation battalion HHC consists of a command group, staff, company headquarters section, supply section, communications/automation section, medical treatment squad, and UMT. The company command group consists of the commander, 1SG, CBRN NCO, and decontamination specialist as shown in chapter 1.

Supply Section

4-101. The supply section consists of the battalion supply sergeant, battalion armorer, and supply specialist. The supply section manages distribution of supplies in support of the battalion. It utilizes unit-level logistics system-ground and standard Army retail supply system-level 1 (SARSS-1) interfaces providing supply receipt and issue management for all classes of supplies except class VIII (medical).

Communications Section

4-102. The communications section consists of a communications section chief, team chief, LAN manager, transmission system operator-maintenance specialists, signal support system maintenance specialists, and radio RETRANS operators. The communications section plans, coordinates, and oversees implementation of communications systems. It performs unit-level maintenance on ground radio and field wire communications equipment and installs, operates, and maintains the radio RETRANS site. The communications section monitors the maintenance status of signal equipment, coordinates preparation and distribution of SOIs, and manages COMSEC activities. The communications section's responsibilities include supervision of electronic mail on both unclassified and classified nets and the LAN.

Unit Ministry Team

4-103. The UMT is comprised of a chaplain and chaplain's assistant. The team provides religious support to all personnel assigned or attached to the battalion and company. The chaplain advises all unit commanders on religious, moral, and Soldier welfare issues, and establishes liaison with UMTs of higher and adjacent units.

Medical Treatment Team

4-104. The HHC's medical treatment section provides health support service (HSS) to battalion. At battalion level, the medical section consists of a flight surgeon, physician's assistant, and health care specialists.

4-105. The medical treatment section consists of two treatment teams (teams A and B). They operate the BAS and provide level I medical care and treatment. This includes sick call, emergency medical treatment (EMT), preventive medicine, and advanced trauma management for wounds, injuries, or illness. The flight surgeon, physician assistant, health care sergeant and specialists provide EMT and assist with advanced trauma management procedures related to their occupational specialties. The treatment teams can operate for limited times in split-based operations in DS of battalion units.

4-106. The medical treatment team usually operates under direction of the battalion main CP. Health care specialists provide medical treatment under supervision of the flight surgeon or physician's assistant. Battalion health care specialists monitor health and hygiene of the battalion, train the battalion's CLS personnel, and treat casualties who require additional care during TACOPs. Medical personnel also provide training in basic first aid and buddy aid; train and direct unit personnel to assist in handling mass casualties; and assist the commander to ensure assigned and attached personnel meet all deployment readiness criteria.

4-107. They also coordinate with the supporting medical platoon in the ASB to assist in MEDEVAC from the point of injury to the level I mission training plan (MTP)/BAS and beyond. The medical sergeant keeps the S-1 and ISGs informed of casualties' status, and coordinates with the S-4 for nonstandard evacuations as needed.

AVIATION SUPPORT BATTALION

4-108. The ASB is the primary aviation logistics organization above the aviation battalion. The ASB is organic to the CAB and provides all logistics functions necessary to sustain the ARB during operations.

4-109. The battalion receives logistics from various elements depending on the logistics organizational structure at brigade and division sustainment brigade. Battalion XOs are responsible to their respective commanders for overwatching sustainment operations and inserting themselves where appropriate to ensure successful sustainment operations for the battalion. The battalion S-4 identifies the logistical requirements for the maneuver plan and provides them to the FSC, ASC or ASB commander as appropriate for the level of command.

AVIATION SUPPORT BATTALION ORGANIZATION

4-110. The ASB (figure 4-2, page 4-18) consists of four companies—HSC, distribution company, network support company, and ASC. Nondivisional ASBs do not have an assigned network support company. The ASB provides aviation and ground field maintenance, network communications, resupply, and medical support. The HSC provides medical support and conducts field-ground maintenance and recovery. The distribution company functions as a SSA and distributes supplies to subordinate units of the CAB. The network support company provides network and signal support to the CAB headquarters. The ASC provides intermediate maintenance and support for on-aircraft and critical off-aircraft field level maintenance and maintenance of UAS. The ASC also conducts BDAR and provides backup support to the aviation maintenance company.

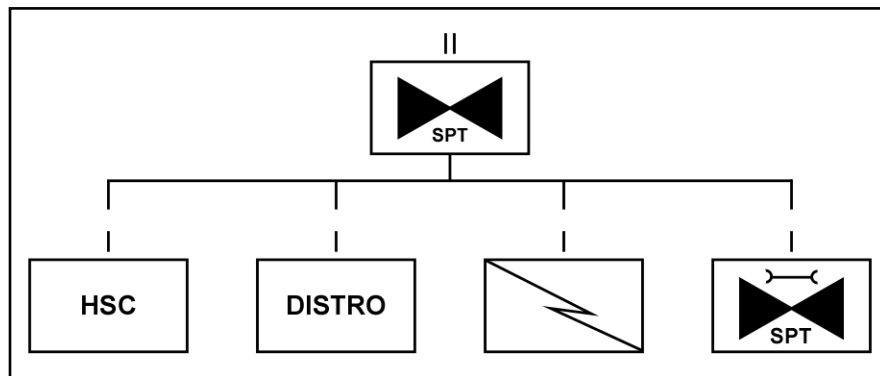

Figure 4-2. Aviation support battalion

Headquarters and Support Company

4-111. The HSC consists of the battalion HSC. The HSC contains a typical battalion staff structure with a command section, S-1 section, consolidated S-2/S-3 section, S-4 section, UMT, S-6 section, and a support operations section. The battalion headquarters provides command, control, and intelligence and administration support for all organic and attached ASB units. The battalion headquarters also plans, directs, and supervises logistics support for the battalions of the aviation brigade. The ASB has an organic combat service support automation management office that provides support to the entire brigade's automation, including the ULLS-A.

4-112. The support operations section is organized to coordinate logistics support and provide distribution management to the aviation brigade. The support operations section is also manned to accomplish contracting, medical logistics, petroleum, ammunition, movement control, transportation, and mortuary affairs functions.

4-113. The support company portion of the HSC provides ground maintenance, medical, supply, and food service support for units organic and attached to the ASB. The maintenance platoon is responsible for field level maintenance for all of the ASB's organic ground equipment.

4-114. The medical platoon provides level I enhanced medical care. The platoon is organized into a headquarters section, a treatment section, and an evacuation section. The medical platoon provides the following capabilities:

- EMT and acute trauma management for wounded, disease and nonbattle injury (DNBI) patients.
- Sick call services.
- Ground ambulance evacuation from supported units.
- Mass casualty triage and management.
- Limited patient decontamination.

Distribution Company

4-115. The distribution company provides a single source for all supply (less class VIII) and transportation operations. The distribution company includes a fuel and water platoon, a supply platoon and a transportation platoon. Much of the capability now resident in this company was formally provided by the main support battalion and corps support group.

4-116. The fuel and water platoon has the capability to store and distribute 105,000 gallons (one DOS) of fuel for the brigade using three load-handling system modular fuel farms. Additionally, the platoon has capability to set up and run multiple refuel points for brigade aircraft. The fuel and water platoon also has capability to purify 30,000 gallons of water daily and can store 18,000 gallons of water. The platoon has an organic quartermaster petroleum QA team assigned to provide QA testing for bulk aviation fuel. The team

performs quality evaluation and provides technical assistance for handling, storing, sampling, and identifying petroleum products and their containers.

4-117. The supply platoon has a SSA and an ammunition transfer holding point (ATHP) section. This platoon provides class II III (P), IV, V, VI, VII, IX and IX (Air) DS to the brigade. The supply platoon receives, stores (limited) and issues class II, III (P), IV, and IX. It also receives and distributes class I and VI under distribution based doctrine of pushing supplies to the FSCs and aviation maintenance companies, and receives and issues class VII as required. The platoon also maintains class II, III (P), IV and IX ASLs for the brigade. The ATHP section supports brigade with class V and operates the brigade ATHP.

4-118. The transportation platoon's purpose is to add organic transportation and distribution capability to the brigade and increases mobility of the ASB. The transportation platoon also has the ability to transport class V and class IX to supported FSCs and ASCs.

Network Support Company

4-119. The network support company provides 24 hour operations supporting the aviation brigade network. It provides signal elements designed to engineer, install, operate, maintain and defend the network. It extends defense information systems network services to the brigade and its subordinate elements and provides basic network management capabilities. During military operations, the company executes its technical mission under functional control of the brigade S-6 based upon brigade OPORDs or other directives. The S-6 directs actions and movement of signal elements in support of brigade operations. The network signal company commander maintains command authority over the company's assigned operational platoons or attached elements.

Aviation Support Company

4-120. Aircraft maintenance above aviation battalion level is provided by the ASB's ASC. The ASC is comprised of four platoons—the headquarters, ARP, CRP, and armament platoon. Modularity within the ASC is based on a contact support team concept and utilizes five shop equipment contact maintenance (SECM) vehicles per platoon. The ASC is capable of supporting brigade split-based operations. The ASC primarily performs intermediate maintenance in accordance with the MAC; however, it also provides back-up unit maintenance in support of the aviation maneuver battalions. The ASC provides aviation logistics support operations for CAB assets. It provides aviation and ground equipment maintenance, in a sustained combat environment, to include limited support for UAS and air traffic control equipment. The ASC also performs production control and QA, conducts maintenance management, and provides MP functions. Additionally, ASCs have six man electro-optics test facility augmentation teams assigned.

Headquarters platoon

4-121. The headquarters platoon contains a production control section, QA section and technical supply section. This platoon provides internal management of repairs, quality of repairs, and logistics support within the battalion. The technical supply section operates logistics STAMIS, requisitions class IX (Air) spares and manages the battalion PLL. Oversight is provided by the battalion aviation material officer assigned to the S-4.

Aircraft repair platoon

4-122. ARPs assigned to an ASC provide field-level maintenance support to in accordance with the MAC. Furthermore, ASC's ARP has the capability to perform limited sustainment-level maintenance in support of the aviation maintenance company's maintenance program. The ASC's ARP also provides technical assistance and maintenance support, when requested by supported aviation maintenance companies, and coordinated through the ASC's production control office. This support entails performing field level to include intermediate and, when authorized, sustainment-level (limited depot) repairs according to applicable TMs, including electronic TM/interactive electronic TMs. AMCOM logistics assistant representatives (LARs) will issue a letter of authorization which authorizes ASC ARP maintainers to perform a one-time sustainment level maintenance repair. The ARP has modular maintenance contact

teams to support battalion-level deployments. ARP personnel, with maintenance officers/technicians, perform in-depth troubleshooting and diagnostics of aircraft systems, subsystems, and components. The ARP also provides repair personnel for technical assistance, contact teams, and aircraft recovery teams. CRP personnel may be attached to ARPs (contact and aircraft recovery teams) to expedite repair of critical components assisting ARP personnel provide rapid turnaround of unserviceable aircraft. The ARP section provides modular support to the aviation maintenance company using contact maintenance teams. The modular support is based on a contact support team concept using five SECM vehicles per platoon.

Component repair platoon

4-123. CRPs assigned to an ASC provide field-level maintenance component repair support functions to the aviation maintenance company's assigned aircraft and corresponding aircraft systems. Furthermore, ASC's CRP can provide unit-level component repair support, when requested by the aviation maintenance companies and coordinated through the ASC's production control office. The CRP performs airframe, LRU, and component repairs to aircraft systems at the ASC. These maintenance procedures entail performing field-level maintenance repairs according to applicable TMs and the MAC. Furthermore, CRPs, are capable of performing limited sustainment. AMCOM LARs will issue a letter of authorization, which authorizes ASC CRP maintainers to perform a one-time sustainment level maintenance repair. Continuous component repair support of aviation maintenance companies and of the reparable exchange (RX) program will increase availability of serviceable aircraft repair parts, thus reducing the customers' aircraft downtime and the logistics tail. Sustaining a balanced approach to the battalion's component repair support program and the RX program will provide aviation maintenance companies required aircraft repair parts when needed.

AVIATION SUPPORT BATTALION MISSION

4-124. The ASB distributes supply classes I, II, III, IV, V, VIII, IX and IX (Air). It performs field maintenance and recovery, both air and ground, and possesses HSS assets to conduct force health protection level I enhanced for the aviation brigade. It carries logistics stocks exceeding the organic carrying capability of the battalions which is generally one DOS for most classes of supply except for class III (Bulk) and class V where it is one combat load for the brigade. The FSCs have the same type of carrying capacity relative to support of their battalion. The ASB plans and coordinates for the aviation brigade's logistics requirements in coordination with the brigade S-4 during the brigade's MDMP. The ASB executes replenishment operations for the FSCs and aviation maintenance companies in concert with the OPLAN developed by brigade. The ASB is the parent battalion headquarters for the network signal company in support of the brigade headquarters.

SECTION V – STANDARD ARMY MANAGEMENT INFORMATION SYSTEMS

STANDARD ARMY MAINTENANCE SYSTEM

4-125. This system includes standard Army maintenance system-level 1 (SAMS-1) and standard Army maintenance system-level 2 (SAMS-2). See FM 3-04.500 for more information.

4-126. STAMIS consists of computer hardware and software systems that automate diverse functions based on validated customer requirements. STAMIS facilitate vertical and horizontal flow of logistics and maintenance status information to units Army wide. Figure 4-3, page 4-21, illustrates the systems that make up the STAMIS architecture. See FM 3-04.500 for more information.

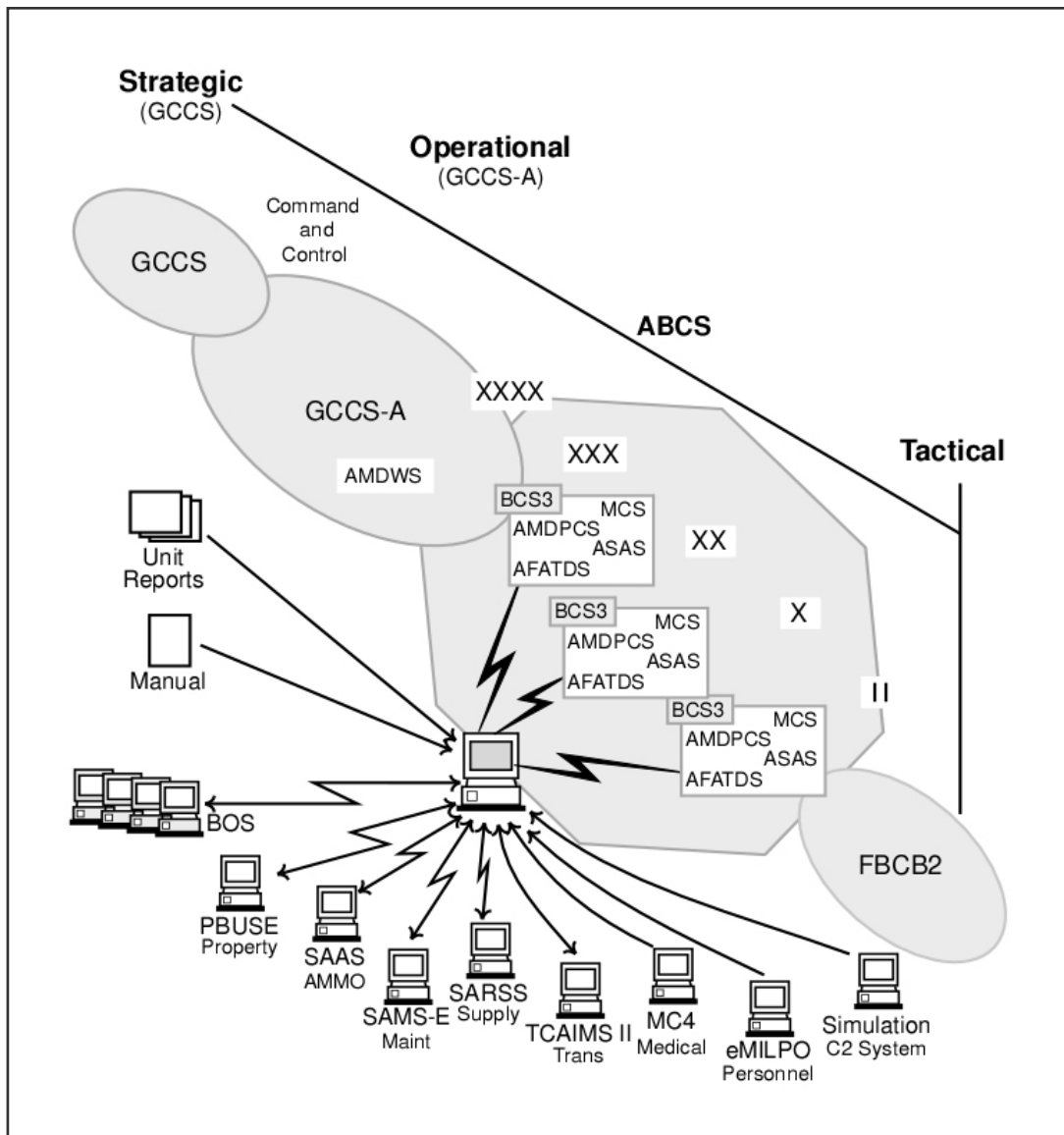

Figure 4-3. Standard army management information system architecture

STANDARD ARMY MAINTENANCE SYSTEM-1

4-127. SAMS-1 enables automated processing of DS/GS maintenance shop production functions, maintenance control work orders, and key supply functions. Requisitions are prepared automatically and automatic status is received from SARSS-1. SAMS-1 has interfaces with other systems such as unit-level logistics systems (ULLSs), SAMS-2, and standard Army retail supply system-Gateway (SARSS-Gateway). It also provides completed work order data to logistics support activity for equipment performance and other analyses.

STANDARD ARMY MAINTENANCE SYSTEM-2

4-128. SAMS-2 is an automated maintenance management system used at the FSC and ASB level. It enables monitoring equipment not mission capable (NMC) status, controlling and coordinating

maintenance actions and repair parts usage to maximize equipment availability. SAMS-2 receives and processes maintenance data to meet information requirements of the manager, and fulfill reporting requirements to customers, higher SAMS-2 sites, and the wholesale maintenance level. Data can be accessed instantly to enable management control, coordination, reports, analysis, and review. SAMS-2 provides maintenance and management information to each level of command from the user to the wholesale and DA levels.

STANDARD ARMY MAINTENANCE SYSTEM-ENHANCED

4-129. Standard Army maintenance system-enhanced (SAMS-E) automates maintenance functions, readiness reporting, unit status reporting functions, and unit-level supply. It provides day-to-day weapon system and subcomponent readiness status and maintenance and related repair parts information. It facilitates management functions from the tactical DS/GS-level maintenance activities and the support field and sustainment maintenance concept (two levels of maintenance). SAMS-E is assigned to ASC and FSC. SAMS-E consists of SAMS-1 and SAMS-2 applications and supports sustainment, TOE, and organizational-level maintenance elements. SAMS-E eliminates duplicate processes but includes critical unit-level functions of equipment operator and qualification, equipment dispatch, equipment PMCS, scheduling and recording, equipment fault records, organizational work order number (ORGWON) generation, Army oil analysis program (AOAP), and Army materiel status system (AMSS) reporting. SAMS-E allows multiple unit identification code (UIC)/Department of Defense Activity Address Code (DODAAC) and stock storage in multiple locations. In addition, SAMS-E—

- Automates unit-level class IX (repair parts) functions.
- Enables same-day processing of requisitions to source of supply, thus minimizing order-ship time.
- Integrates supply and maintenance applications to eliminate redundant functions.
- Automates demand history and stockage-level computations to avoid out-of-stock or excess conditions.
- Uses both federal logistics (FEDLOG) and the standard Army retail supply system (SARSS) catalog update.
- Identifies units as either direct or indirect (supported customer).
- Generates a work order automatically when an operator-level fault is initiated and the part received.
- Changes management of unit data from DODAAC-based to UIC-based selection and entry.
- Retains the man-hour accounting on/off switch as an option in case of deployment.
- Provides password protection to the operational processes and data elements.

PROPERTY BOOK AND UNIT SUPPLY ENHANCED PROGRAM

4-130. Property book and unit supply system-enhanced (PBUSE) is the Army's Web-based, state-of-the-art, sustainment property accountability system. PBUSE features provide standard property book system-redesign functionality and data access by permission control system for both garrison and tactical environments. When tactical requirements dictate and direct connection to the Web is not possible, the system operates in a disconnected standalone mode. Upon completion of a standalone tactical requirement, the system is reconnected to the Web for resynchronization of the user's data to the central database. PBUSE reduces the footprint and infrastructure requirements by consolidating two baselines into one. The system functionality provides much efficiency for the logistics community. With PBUSE, the commander has a real-time view of assets, accurate visibility of the unit's property book account operating on the AKO portal, which allows him to access the system for queries without having to depend on the PBO to gather, prepare, and present the information. PBUSE also provides:

- Real-time total asset visibility throughout all levels of Army management.
- Automatic Logistics Army Authorization Document System (LOGTAADS) updates; LOGTAADS is a by-product of an MTOE. LOGTAADS, an electronic version of the MTOE, updates PBUSE and other property book accounting systems.

- Elimination of unique item tracking reporting through automatic serial number tracking.
- Automated catalog changes.
- Unit transfer/TF/split operations.

STANDARD ARMY RETAIL SUPPLY SYSTEM

4-131. SARSS is a multiechelon supply management and stock control system that operates in tactical and garrison environments. SARSS comprises SARSS-1 (at the SSA), standard Army retail supply system-level 2 (SARSS-2) A/C, or corps/theater automated data processing service center (CTASC), and SARSS-Gateway. SARSS provides supply-related data to the Integrated Logistics Analysis Program (ILAP) at various functional levels. SARSS supports ULLS, standard Army maintenance system (SAMS), PBUSE, nonautomated customers, and the dual-based operations concept. SARSS is fully integrated from the user through theater Army level. It can support worldwide deployment of combat forces to contemporary operating environments to include stability and civil support operations missions.

STANDARD ARMY RETAIL SUPPLY SYSTEM-1

4-132. SARSS-1 is the standard supply system used for receipt, issue, replenishment, and storage operations. It operates at the ASB's SSA and combat support battalions. SARSS-1 in each supply echelon is capable of sustaining prime support responsibilities for each customer's unit. Each customer unit can interact directly with any SARSS-1. SARSS-1 is the system of record. It maintains accountable balances and is supported by a SARSS-2A activity. It depends on SARSS-2B for catalog support and computation of stockage levels.

STANDARD ARMY RETAIL SUPPLY SYSTEM-2A/C/CORPS/THEATER AUTOMATED DATA PROCESSING SERVICE CENTER

4-133. SARSS-2A performs time-sensitive supply functions. These include management of controlled items, lateral search of stocks to fulfill unsatisfied customer's requirements from subordinate SARSS-1 activities, and redistribution of excess. SARSS-2 A/C operates on CTASC hardware. SARSS2-AC/CTASC performs time-sensitive supply management functions for referral, excess disposition, and management for classes II, III (P), IV, VII and IX (Air). It manages redistribution of supplies. SARSS 2 A/C/CTASC also maintains a custodial availability balance file that provides visibility of SARSS-1 assets to include both divisional and nondivisional functions.

STANDARD ARMY RETAIL SUPPLY SYSTEM-2B

4-134. SARSS-2B performs management functions that are not time sensitive. These include document history, demand analysis, and catalog updates at installation and United States Property and Fiscal Officer. It supports subordinate SARSS-1 and SARSS-2A by performing stockage-level computations, tailoring catalog files, and maintaining active and inactive document history data.

STANDARD ARMY RETAIL SUPPLY SYSTEM-GATEWAY

4-135. SARSS-Gateway is an interactive/batch-oriented transaction processor that routes transactions to and from each interfacing STAMIS. It provides a communications network and the capability to send transactions to the defense automatic addressing system (DAAS). It provides the appearance of a seamless, near real-time supply system to unit-level supply and maintenance activities. SARSS-Gateway provides customer access to all assets that are available within a specified geographical area. Requests are electronically transmitted from customers to a gateway computer, where lateral search/issue decisions are made based on the ABF residing there. If assets are not available, the gateway forwards the request to the wholesale SOS and provides status to customers on the actions taken.

UNIT-LEVEL LOGISTICS SYSTEM—AVIATION

4-136. The ULLS-A program will enhance the Army's ability to more accurately track and control aviation maintenance, logistics, and aircraft forms and records. The ULLS-A program is designed to be user friendly while reducing man-hours through complete automation. The ULLS-A is an innovative tool that assists aviation maintenance personnel with various tools to enhance aircraft reporting, status, and flying hours according to AR 700-138. Furthermore, ULLS-A can process aircraft transfers, maintain operational and historical records, process class IX (Air) repair parts, and enhance maintenance operations overall. In addition, ULLS-A automates bench stock listings by shop codes (stocked and maintained manually with an automated reordering process), PLL, reportable component management, and maintenance management processes performed by production control. ULLS-A is currently the system of record for all PLL/bench stock and the Army maintenance management system-aviation operations at the unit level. ULLS-A enhances and supports those tasks associated with controlled exchange of reportable components listed in TB 1-1500-341-04.

4-137. ULLS-A at the aviation maintenance company is configured into a network operation. A notebook computer assigned to line companies facilitates those tasks previously performed on the manual logbook. Army aviation units are normally supported by three workstation computers (production control, quality control, and technical supply) and a file server (database) positioned in the production control office. These automated systems comprise the LAN. Tasks and activities performed by quality and production control are transferred to the aircraft notebook. These procedures will ensure that the ULLS-A is current and reflects the latest maintenance and logistics status assigned to the airframe.

4-138. ASCs are provided with an ULLS-A which supports those activities necessary to perform field maintenance support for customers and operational readiness float/RTF aircraft. If an aircraft is work ordered to an ASC, the logbook and laptop computer assigned to the aircraft will accompany the aircraft to track and record all performed maintenance actions. The ULLS-A provides production control with the ability to generate and manage ASC-level work orders and post statuses to the maintenance request register. ULLS-A provides the vehicle to produce and manage internal work orders (intrashop), which are printed and supplied to the ASC component and ARPs.

Note. ULLS-A is currently being fielded to Army aviation units. ULLS-A, once fielded, will be the system of record to track all logistics and maintenance actions for all aviation maintenance units. The manual system (hard copies of forms and records) will be used as a backup if ULLS-A becomes nonfunctional. The production control office is responsible for coordinating the input and update of all maintenance and logistics actions into ULLS-A once the system is fully operational.

INTEGRATED LOGISTICS ANALYSIS PROGRAM

4-139. ILAP is the standard management tool used by the Army that collects, integrates, and displays logistics and financial data. ILAP operates at all echelons of the Army to provide management capability to unit, corps, installation, component, and theater levels. Financial data are pulled from Defense Finance and Accounting Service data sites. Logistics data are obtained from appropriate supply and maintenance sites. The cross-functional data are integrated and aggregated to upper echelons to provide summary decision support views and detailed information drill-down capabilities to the document detail level. This process of assembly and aggregation affords Army departmental users the opportunity to do Army-level analysis and data query. ILAP augments the STAMIS. Managers at all levels execute their duties more efficiently and effectively by using integrated ILAP data. ILAP is most useful for managers who require data from disparate and isolated sources because ILAP virtually eliminates the time required for retrieval, integration, and display to support management analysis.

DEFENSE AUTOMATIC ADDRESSING SYSTEM

4-140. The logistics information processing system, maintained by the DAAS, is DOD's central repository for information on the status of requisitions. It also augments global transportation network in monitoring the status of non-unit cargo shipments.

AVIATION LIFE SUPPORT SYSTEM

4-141. Commanders ensure mission-required ALSE is on hand in sufficient quantities, and equipment is in serviceable condition. To meet the Army's demanding transformation requirements, newer and more complex integrated systems are being fielded. These systems demand better maintenance planning, higher maintenance skills, and dedicated facilities.

4-142. Commanders are required to establish an ALSS maintenance management and training program budget to meet resource requirements. Funding for equipment, supplies, and repair parts is imperative. When preparing the budget, review AR 95-1; common table of allowances (CTAs) 8-100, 50-900, and 50-909; and applicable MTOEs and tables of distribution and allowances.

Appendix A

Aircraft Survivability

Aircraft survivability is a primary concern throughout planning and execution of all missions. Army aircrews operate in an extremely hazardous environment of highly lethal AD threats. The array of enemy AD systems includes radar, IR, optical/EO, laser and directed-energy weapons (DEWs). Proper use of ASE, combined with careful route planning and movement techniques, greatly reduces the enemy's ability to effectively engage Army helicopters.

SECTION I – THREAT WEAPON SENSORS

A-1. There are four major types of threat weapon sensors—radar, IR, DEW, and EO. These must be man portable or transportable by land, sea, or aerial platforms. Actual sensor type and guidance package for each threat should be determined and its inherent capabilities and limitations understood. The four major types of threat weapon sensors are discussed below.

RADAR

A-2. Direct-threat radar weapons require LOS to hit the target. These radar weapons are either fire-controlled AAA or, for missile systems, controlled by command, semi-active radar homing, active-radar homing, track via missile, or ground-aided seeker. Radar weapons must detect, acquire, track, launch and guide (or fire a ballistic solution), and assess damage. Radar systems have trouble with ground clutter; to pick out targets from ground clutter, radar systems can detect movement using a moving target indicator, Doppler (continuous-wave radar), or pulse Doppler. Some modern radar systems can and do track not only the movement of the aircraft itself but also the rotor blades. A few older radar systems had blind speeds—called a Doppler notch—where they could not detect an aircraft flying a specific speed toward or away from the radar. However, modern radar systems cancel blind speeds. Even with older radar systems, aircraft had difficulty maintaining constant speed and angle to or from one radar; it is impossible to be in Doppler notch of more than one radar. Radar systems can be detected, avoided, decoyed, jammed, and destroyed by direct and indirect fires—self, artillery, and antiradiation missiles.

INFRARED

A-3. All IR direct-threat weapons require LOS be established before launch; the in-flight missile must maintain LOS with the target until impact or detonation by the proximity fuse. IR missiles require the operator visually detect the target and energize the seeker before the sensor acquires the target. The operator must track the target with the seeker caged to the LOS until it is determined the seeker is tracking the target and not background objects—such as natural or manmade objects to include vehicles, the sun, or energy of the sun reflected off clouds. The IR sensor is also susceptible to atmospheric conditions (haze or humidity), the signature of the aircraft and its background, flares, decoys, and jamming. Generally, IR systems are difficult to—

- Detect before launch (passive sensor).
- Predict location (portability).
- Respond to (short time of flight after launch).
- Hard kill (requires shooting at an in-flight missile).

LASER AND DIRECTED-ENERGY WEAPONS

A-4. Laser/DEW weapons are two distinct categories—laser-guided or laser-aided weapons and pure laser/DEW weapons. Laser-guided or laser-aided weapons use laser for ranging, tracking, or guiding functions of conventional explosive missiles or projectiles. Pure laser/DEW weapons use laser and other forms of DEW to inflict damage to aircraft or its sensors (the aircrew's eyes may be damaged). Pure laser/DEW weapons are not required to burn a hole in the target to destroy it—although these weapons are reaching such capability. Simply igniting fuel vapor near vents or burning through fuel lines is effective as well as glazing cockpit glass so aircrew cannot see out. Inherently, laser/DEW weapons are of short duration, hard to detect, extremely hard to decoy or jam, and hard to kill. Fortunately, they must rely upon LOS and atmospheric conditions and have a somewhat short range.

OPTICAL/ELECTRO-OPTICAL

A-5. Optical/EO sensors are used as either primary or secondary sensor for all weapon systems. Although they rely on LOS, they are, with very few exceptions, completely passive. They are limited by human eyes, atmospheric conditions, distance, jitter, and in many cases, darkness. The optical/EO sensors are the most difficult to detect, seldom decoyed, and can be jammed in the sense of obscurants but, when located, can be hard to kill.

SECTION II – OPERATIONAL EMPLOYMENT CONSIDERATIONS

A-6. Aircraft survivability functions must be included throughout mission planning, rehearsal, execution, and recovery operations. Intelligence drives operations, and mission planning begins with receipt of situation and mission and continues through completion of mission execution and AAR. From receipt of enemy situation and mission, it is important to plan and integrate aircraft survivability functions.

A-7. For ASE to provide effective protection, configuration settings must be optimized for known and suspected threats. TACOPS ensure optimum ASE configuration settings are prepared and briefed for each flight. TACOPS give consideration for each system and settings for specific theater of operation.

MISSION PLANNING

A-8. ASE and EW must be considered in all phases of mission planning and execution. Figure A-1, page A-3, illustrates roles and responsibilities of ASE planning.

A-9. Once initial analysis of information is completed, the battalion S-3 notifies the battalion TACOPS and begins the planning cycle. The level of planning involved is always predicated on time, information, and personnel available. OPODs for military operations are extensive in scope and contain information acting as a baseline for most unit operations.

A-10. The generation of the OPOD begins upon receipt of enemy and friendly situation, mission, and commander's intent. The EW annex is created to support the OPOD using this information. Enemy and friendly situations are further defined with emphasis on EW capabilities; each one finds, fixes, jams, deceives, disrupts, or destroys the other. Once the situation is clearly defined, the mission is analyzed to evaluate risk to friendly forces while accomplishing the mission within prescribed guidelines. After risk assessment is complete, risk reduction techniques are specified in the execution instructions. These techniques require commander's approval if mission constraints need to be altered significantly from original intent. The next step is determining service support for EW and command and signal guidance necessary to accomplish the EW phase of the mission.

A-11. ASE settings depend on accurately analyzing enemy AD threat. Knowing the threat is critical to effective passive and active countermeasures. Unit TACOPS provide ASE settings/codes for training and deployment.

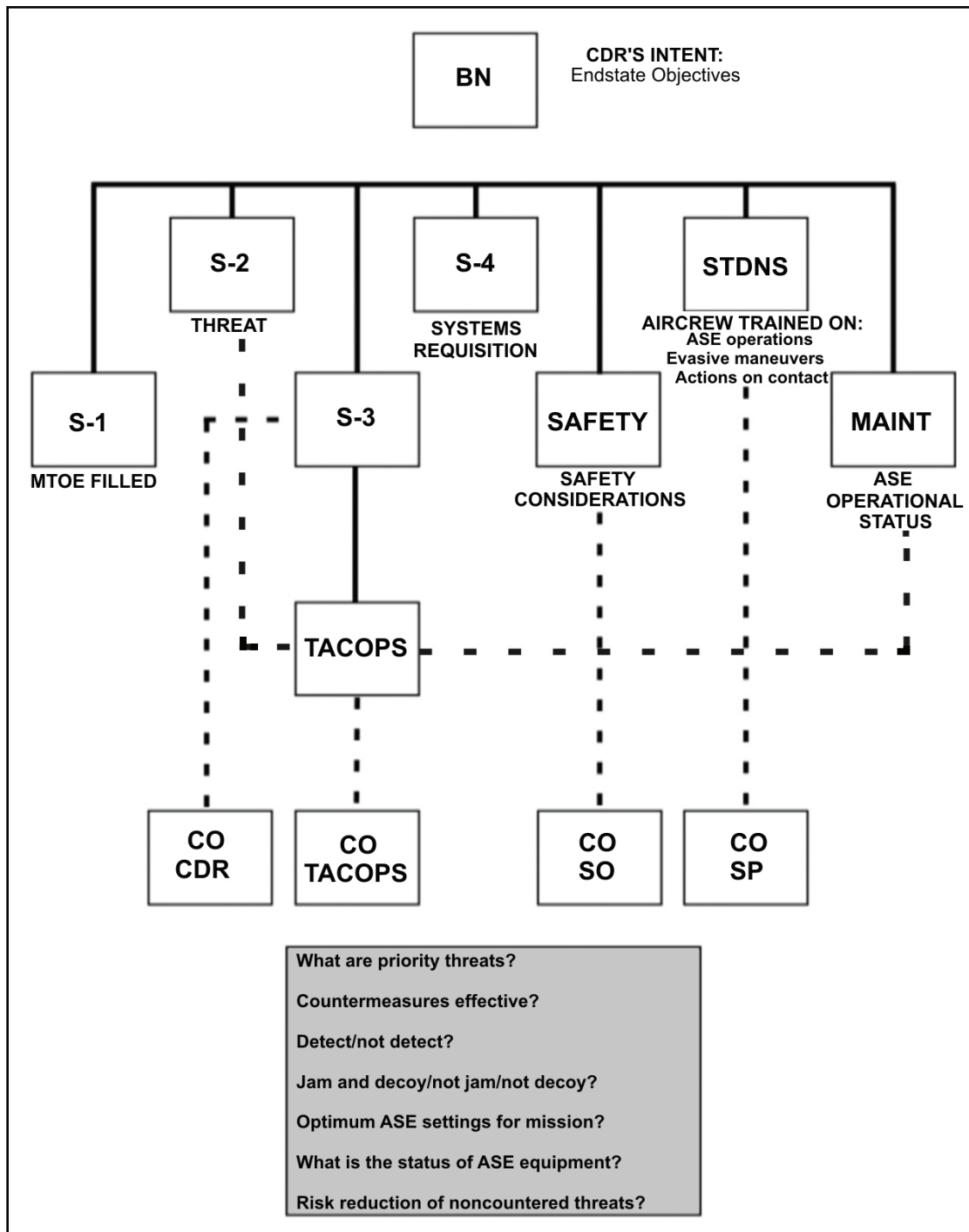

Figure A-1. Roles and functions

AIRCRAFT SURVIVABILITY EQUIPMENT RISK ANALYSIS

IDENTIFYING RISK

A-12. To perform a thorough risk assessment, detailed information about threat system operating procedures, tactics, system capabilities, and locations must be analyzed to determine enemy advantages or disadvantages in use of EW. Capabilities and limitations of friendly EW systems are compared to threats assessing level of risk associated with the mission. S-2s and TACOPS officers identify the following for companies:

- Operating frequencies of radar threats.
- RF threats that can or cannot be detected.
- RF threats radar jamming equipment will affect (includes the extent of success jamming has).
- RF threats that can be decoyed (includes the extent of success decoying has).
- IR threats that may be encountered.
- IR threats that can be detected.
- IR threats that can be jammed or decoyed (effectiveness of jamming and decoying).
- Laser threats that can or cannot be detected.
- Optical/EO threats.

ELECTRONIC INTELLIGENCE PRIORITY INTELLIGENCE REPORTS

A-13. Battalion sends electronic intelligence (ELINT) PIR to higher requesting specific threat emitter data on any templated EW/AD threats. Tabular data associated with any radar hits should also be requested.

ASSESSING RISK

A-14. Companies prioritize threat systems and optimize ASE settings for highest priority threats. Level of risk is determined based on threat and ASE capabilities and limitations and mission (use DA Form 7573, Aircraft Survivability Equipment (ASE) Risk Assessment Worksheet Survivability Risk Analysis). The highest risk is used to determine overall risk to the mission. If risk due to IR threats is high, then overall mission risk would continue to be high risk. The risk assessment worksheet is used to determine what is causing the highest risks so controls can be developed to reduce those risks.

Note: Select initial settings for RFI MODE, PRIORITY scheme and TERRAIN to enhance ability of the AH-64D to detect threats.

Note: Mixed formations must consider suppressed/unsuppressed aircraft configurations when conducting ASE risk analysis/mission planning.

DEVELOP CONTROLS

A-15. Optimum ASE configuration settings for each aircraft type and threats in the mission area are determined based on doctrinal assets and requested ELINT PIRs. Threats which are highly lethal and not countered by ASE are identified and PIRs are developed and submitted by the S-2 to higher headquarters. Additional requirements include—

- Briefing the S-3 and higher commander on any medium or high risks associated with executing the planned mission.
- Using AMPS to display high threat areas.
- Making recommendations to higher commander to reduce risk.
 - Adjusting routes, ABFs, and/or EAs.
 - Adjusting time of mission.
 - Employing artillery and smoke to reduce threat to aircraft.
 - Requesting joint EW assets.

A-16. Apply risk reduction techniques to minimize risk and enhance probability of survival. These measures include—

- Planning mission time earlier or later to take advantage of night operations.
- Planning J-SEAD at critical points to reduce vulnerability.
- Altering flight routes to avoid known AD areas.
- Altering formation size to reduce signature.

IMPLEMENT CONTROLS

A-17. Commanders and aircrews must take an active role in reducing risks by implementing controls and supervising their implementation.

- Commanders ensure ASE/EW considerations and configuration settings are briefed to all aircrews and maintenance personnel.
- Aircrews ensure ASE settings are correct during preflight ASE checks.
- Aircrews ensure IFF codes are activated and deactivated at proper times and locations during mission execution.
- Commanders collect debriefings from aircrews during AAR.
- Aircrews report all ASE/EW abnormalities experienced during flight (ambiguities, false alarms, equipment failures).
- Commanders ensure all ASE/EW data are entered into AMPS for the next mission (threat data, countermeasure responses, locations of false alarms, friendly systems reported as threats).

MISSION BRIEF

A-18. The ASE/EW mission briefing disseminates information and instructions to aircrews prior to the mission. At least four hours prior to mission execution, the AMC requests an ELINT update. The briefing alerts aircrews to risks associated with threats, optimum ASE settings, and a review of tactics specific to the mission. These tactics include evasive maneuvers, actions on contact, multiship breakup and reformation procedures, and ROE for countermeasures weapons employment. Figure A-2, page A-6, illustrates an example of ASE/EW mission brief format.

MISSION EXECUTION

A-19. During conduct of the mission, it is important for aircrews to be familiar with ASE SA displays and expected threat indications. Some actions must be performed without delay. When visual indications of a gun or missile are fired at an aircraft, or ASE indications of radar track or launch, the aircrew has only seconds to perform an action preventing the aircraft from being hit. Three distinct parts of reacting to threat engagements are:

- Indication (determines immediate action and deploys to cover).
- Perform evasive maneuver and expend countermeasures (if applicable), if masking terrain is not readily available.
- Perform actions on contact (decision to continue or abort mission).

CREW COORDINATION

A-20. Crew coordination must be rehearsed to perform evasive maneuvers. Standardized terminology, such as “missile 3 o’clock, break right” and “break left” should be used to avoid confusion. At other times, indications do not require evasive maneuvering, such as radar search or acquisition.

OVERALL RISK:	Low	Medium	High
CAUSED BY:	Mission profile ASE suite Threat		
ASE and IFF configuration settings:			
ASE can detect:			
ASE cannot detect:			
ASE can jam:			
ASE cannot jam:			
Primary threats:	IR RF EO Laser/DEW		
Risk-reduction measures:			
Changes to standard TTPs:			
QUESTIONS:			

Figure A-2. Example aircraft survivability equipment/electronic warfare mission brief format

MULTISHIP CONSIDERATIONS

A-21. Formations and spacing intervals should be selected to provide all aircraft maneuver space evading hostile fire. Standardized terminology, such as “Team 2 break right, missile” or “Team 1, tracers, three o’clock, break left”, should be used to alert the flight to your actions. Briefings should include evasive formation breakup procedures and how to reestablish formation after breaking engagement. It is important for one aircraft in the formation to communicate its ASE indications to the other aircraft since it may be the

only one receiving indications due to terrain, narrow radar beam, altitude, or maintenance problems. See TC 1-201 for more information.

SECTION III – AIRCRAFT SURVIVABILITY EQUIPMENT/ELECTRONIC WARFARE TRAINING

A-22. The company commander is responsible for training management and documentation of the company's ASE/EW program. This section discusses the ASE/EW management process and training responsibilities within the company.

A-23. The company ASE/EW program will undergo periodic inspections (Command Inspection Program, Forces Command Aviation Resource Management Survey, Directorate of Evaluation and Standardization, division "fly-away" inspections, and external evaluations). When inspections of this nature are conducted, aviation resource management survey (ARMS) evaluation guidelines are used as evaluation criteria.

TRAINING ASSETS

A-24. ASE/EW training must be conducted on an on-going basis ensuring aircrews are ready to operate on today's and tomorrow's battlefield. Training should be conducted at individual, crew, and collective levels. Company commanders are required to designate CBAT requirements in accordance with TC 1-210. Commanders, TACOPS, ASE officers, and unit standardization personnel plan and implement training. The following assets are available for ASE/EW training at levels indicated:

- Individual.
 - Academic training and study.
 - CBAT.
 - Synthetic Flight Training System, Cockpit Trainer.
 - ATM flights.
- Crew.
 - Academic training and study.
 - CBAT.
 - ASET IV (when available).
 - Manportable RF/IR/IV simulators.
 - EW ranges.
 - Combat training centers (CTCs).
 - Longbow Cockpit Trainer.
 - Onboard ASE trainers (when available).
- Collective.
 - ASET IV (when available).
 - Manportable RF/IR/IV simulators.
 - EW ranges.
 - CTCs.

TRAINING RESPONSIBILITIES

COMPANY COMMANDER

A-25. The commander is responsible for planning, executing, and documenting the company ASE/EW program. Other responsibilities include—

- Integrating CBAT into unit ATP.
- Providing necessary equipment to conduct CBAT training.
- Ensuring compliance with procedures for safekeeping and storage of classified material.

- Ensuring compliance with security regulations.
- Incorporating IFF training and verification plan into all unit collective training events.

COMPANY TACTICAL OPERATIONS OFFICER

A-26. The company TACOPS officer is authorized per MTOE. The TACOPS officer is school trained with an additional skill identifier. The TACOPS officer's responsibilities include—

- Ensuring optimum ASE reprogramming is completed for AOR (settings may be changed during routine maintenance exchanges).
- Advising the commander with ASE/threat analysis.
- Performing tactical route mission planning.
- Tracking all ASE equipment assigned to company.
- Ensuring procedures for storage and safekeeping of classified materials are followed.
- Conducting monthly inventories of all ASE/EW hardware and software. Forwarding results of inventory to battalion TACOPS officers and S-2.
- Maintaining security clearance access roster (SCAR) and monitoring usage of CBAT .
- Ensuring a designated, secure area is available for CBAT training. These areas must meet all security requirements.
- Reporting completion of CBAT requirements to company SP.
- Assisting with threat and countermeasures briefs; assisting in establishment of unit-level ASE training.
- Developing and maintaining unit ASE/EW SOP.
- Ensuring unit complies with FORSCOM ARMS ASE checklist.

COMPANY STANDARDIZATION INSTRUCTOR PILOT

A-27. The company SP assists the commander in implementation of the unit ASE/EW training plan. Other responsibilities include—

- Assisting commander by developing training programs and/or STX scenarios using flight simulators and aircraft to train and evaluate crew ASE/EW qualification and proficiency.
- Ensuring IATFs accurately reflect individual training.

Appendix B

Army Aviation Air-Ground Integration

Operations must be integrated so air and ground forces can simultaneously work in the operational environment to achieve a common objective. Integration maximizes combat power through synergy of both forces. The synchronization of aviation operations into the ground commander's scheme of maneuver may also require integration of other services or coalition partners. It may also require integration of attack reconnaissance, assault, and cargo helicopters. Attack reconnaissance units often engage targets near friendly forces and noncombatants during various types of operations including shaping, decisive, and sustaining operations.

SECTION I – COMBAT IDENTIFICATION

B-1. Combat identification is the process of attaining an accurate characterization of detected objects in the operational environment sufficient to support an engagement decision. The combat identification process has three key purposes—to identify and classify targets in the battlespace; to allow for the timely application of the appropriate weapon system(s) on targets classified as enemy; and the mitigation of fratricide and collateral damage to noncombatants.

B-2. The combat identification process is a series of progressive and interdependent steps (or actions)—target search, detection, location, and identification that lead to the decision process to engage or not engage. The detect, identify, decide, engage, and assess (DIDEA) process provides an iterative, standardized, and systematic approach supporting the application of specific combat identification and ROE performance steps to target engagement activities. The individual actions of the DIDEA process are summarized in table B-1.

Table B-1. Individual actions on the detect, identify, decide, engage, and assess process

<p>Detect – the acquisition and location of an object in the operational environment. This first step in the Universal Target Engagement Process can entail the use of visual, sensor, radar, electronic signals measurement, or other means for detecting and locating objects in the operational environment.</p>
<p>Identify – a systematic process supporting the characterization of detected objects as friend, enemy, neutral, or unknown. This is the primary step where specified CID tasks are accomplished. It commences after an object is detected and located and provides a systematic process whereby the attributes of a detected object are systematically processed to support a friend, enemy, neutral or unknown determination. In some cases, the characterization process may need to be further refined to include specific class, type, and nationality determinations.</p>
<p>Decide – determination of appropriate application of military options and weapons resources on identified objects. This is the most generic step within the process and is the primary step where specified ROE application takes place. Specific substeps within the decide phase will vary depending on the weapon system/platform and mission application. In some cases the decision may be made to employ military options other than weapons systems (such as the repositioning of ISR assets for further monitoring of identified objects). In those cases where a weapons resource application is being considered, this phase would primarily address the following questions:</p> <ul style="list-style-type: none">• Can I engage? (ROE application)• If multiple targets, what to engage first? (severity of threat, commander's intent/HPTs)• What is the best weapons system to engage with? (lethal/nonlethal, munitions effect, collateral damage assessment)

Table B-1. Individual actions on the detect, identify, decide, engage, and assess process

Engage – specific application of military options/weapons resources. In this step the mechanical process of carrying out the decision made in the previous step takes place.

Assess – did the applied weapons resources bring about the desired effect. In this step we assess the effects of the engagement phase against desired outcomes. If the desired outcome was not achieved, a decision to re-engage the target could be made.

GROUND UNIT AND AVIATION TASK FORCE COORDINATION

B-3. Ground maneuver commanders must understand that aviation forces can provide a significant advantage during operations. In addition, ground maneuver planners must understand that the unique capabilities of Army aviation also require unique planning and coordination. Army aviation forces must be fully integrated in the MDMP to ensure effective combined arms employment. Effective combined arms employment also requires that aviation and ground maneuver forces synchronize their operations by operating from a common perspective. See FM 3-06.11 for additional information.

SUPPORT FOR GROUND MANEUVER UNITS

B-4. Ground units may receive support from a variety of attack reconnaissance helicopters including the AH-64 and OH-58D. Attack reconnaissance helicopters can provide area fire to suppress targets, and precision fire to destroy specific targets or breach structures. Attack reconnaissance helicopters can also assist with ISR and communications using their advanced suite of sensors and radios. Other supporting helicopters, such as the UH-60 and CH-47, may also have weapon systems (7.62-mm or .50-cal) that aid in the suppression of enemy forces when operating in urban terrain. However, their primary role is to transport personnel, equipment, and supplies to those critical urban areas. Utility and cargo helicopters can provide a distinct advantage by placing personnel and weapon systems at critical locations at critical times to surprise and overwhelm the enemy. Utility and cargo helicopters can also transport needed supplies to urban areas that may be inaccessible to ground transportation.

GROUND MANEUVER UNIT PLANNING REQUIREMENTS

B-5. The ground maneuver brigade, through their aviation LNO and BAE, provide the aviation headquarters the necessary information to meet planning requirements. The initial planning and information to be passed to the aviation headquarters includes the location of the HA, the air axis, and the route or corridor for entry and exit through the brigade and battalion sector. Other planning requirements may include—

- Establish command relationship between supported unit and supporting aircraft.
- Give initial task and purpose to aircrews.
- Give ATF current situation estimate (intelligence and operations).
- Review any updates to the joint A2C2 structure.
- Pass call sign and frequencies for ground elements.
- Establish any control measures (recommended HAs, ROZs, NFAs, BPs, LZs, PZs, or EAs).

WEAPONS INTEGRATION

ACTIONS EN ROUTE TO THE OBJECTIVE

B-6. The ground maneuver headquarters informs its units in contact when aircraft are inbound. En route to the HA, the AMC contacts the ground maneuver element on the FM command network for a SITREP on enemy and friendly forces.

B-7. A battalion close fight SITREP may consist of the following:

- Enemy situation (composition and disposition to include threat to aviation, recent enemy contacts, and threats to ground maneuver element).
- Friendly situation (including any A2C2 deconfliction with UAS or indirect fires vicinity of the operation).
- Recommended routing to the contact.
- Restrictions or constraints.

AVIATION TEAM CHECK-IN

B-8. It is essential to positively identify locations of friendly units and supporting aircraft. Aircrews confirm, with each other or wingmen, their positive location. Ground elements must be extremely careful when verifying any position information.

B-9. The aviation team usually checks-in using the command net of the unit having the element in contact or as directed in the mission briefing. Upon initial radio contact, the aviation team leader executes a check-in. The team's location may be expressed by grid coordinates or position with respect to a known point or common graphics. At check-in the team leader provides the following:

- Identification. “(Ground commander), this is the (ARC commander/AMC).”
- Team composition, location, and ETA (include type and number of aircraft in the team).
- Munitions available (include type and amount of ordnance).
- Station time/special capabilities (such as NVGs, TIS, AIM-1).
- A request for ground SITREP, which includes UAS activity.

B-10. The aviation team, if required, selects and occupies a holding or orbit area within FM communications range until required coordination is complete. High-density altitudes may preclude hovering by a fully loaded aircraft. The aviation team may need to establish a racetrack orbit oriented behind the BP, ABF, or SBF position. The AMC informs the ground unit leader of the orbiting pattern or series of positions his team will occupy.

B-11. The BP, ABF, or SBF is normally offset from the flank of the friendly ground position but close enough to facilitate efficient target handoffs. This ensures rotor wash, back blast, ammunition casing expenditure, and general signature of aircraft do not interfere with operations on the ground or reveal ground unit positions. The offset position also allows aircraft to engage the enemy on its flanks, rather than its front, and lessens risk of fratricide along the helicopter gun-target line. Friendly forces should clear any positions over which helicopters may hover or orbit precluding engagement by hidden enemy forces.

B-12. The AMC provides the ground maneuver unit leader with his concept for the operation. This briefing may be as simple as relaying direction of aircraft approach or attack route and time required to move to the recommended BP. On completion of coordination with the lowest unit in contact, the flight departs the holding or orbit area.

B-13. The main reason for using several weapons systems at once is to overwhelm the enemy with more than it can counter. When possible, units sequence employment of CAS, indirect fires, direct fires, and armed helicopters so closely they seem simultaneous in fire effects. This action may be conducted as a JAAT, mission fires are lifted or shifted at the most advantageous time for ground elements to overwhelm the objective before the enemy can offer effective opposition.

B-14. Army aviators may be key in controlling employment of multiple weapons systems because of their vantage point in the operational environment and ability to quickly relocate. Aviation units must routinely train with ground units so they can effectively employ other Army and joint weapons systems.

INTEGRATED OPERATIONS

B-15. True integration occurs when the commander effectively uses every available asset to its fullest extent. The following are some available assets and capabilities:

- CAS elements destroy enemy formations and installations.
- Attack reconnaissance and ground units search in front of the ground force, confirm enemy strengths and weaknesses, protect flanks, and allow the commander to orient on threats or exploit opportunities.
- Tank, mechanized infantry, light infantry, and air assault units—accompanied by AD and engineer elements, as appropriate—forcibly take and occupy key terrain or deny terrain to the enemy.
- Attack reconnaissance helicopters maneuver to attack enemy forces and deny terrain for limited periods.
- UH-60 helicopters move troops, light vehicles, light artillery, and supplies; they also can emplace minefields and augment C2.
- CH-47 helicopters move troops, medium vehicles, medium artillery, and supplies.
- Artillery provides indirect fires to disrupt and destroy enemy formations; aviation and ground forces also employ artillery for immediate suppression of enemy elements until they can maneuver and eliminate the threat (J-SEAD, SEAD, on-call FS).

POSITIVE LOCATION/TARGET IDENTIFICATION

COMMAND AND CONTROL TECHNIQUES

B-16. C2 techniques effective during air-ground operations with Army aircraft are:

- Reference point technique—uses a known TRP or an easily recognizable terrain feature.
- Grid technique—uses grid coordinates to define the point.
- Sector/terrain technique—uses terrain and graphics available to both air and ground units.
- PL technique—uses graphics available to both air and ground units.

MARKING

B-17. There are various ways to mark a location or target. The effectiveness of vision systems on helicopters compares to those found on ground vehicles. During the day, the vision systems of AH-64 and OH-58D aircraft allow accurate identification of targets. During periods of reduced visibility, resolution is greatly degraded, requiring additional methods of verification. This situation requires extra efforts from both ground unit and aviation element.

B-18. Some United States weapons can kill targets beyond ranges that thermal, optical, and radar acquisition devices can provide positive identification. Both aviation and ground forces may become overloaded with tasks in the heat of battle. Simple positive identification procedures must be established and known to all.

Marking Friendly Positions

B-19. A method of target identification is direction and distance from friendly forces. Friendly forces can mark their own positions with IR strobes or tape, NVG lights, smoke, signal panels, body position, MRE heaters, chemical lights, and mirrors. Marking friendly positions is the least desirable method of target location information and should be used with extreme caution. Marking friendly positions can be a more time-consuming process than directly marking a target and can reveal friendly positions to the enemy.

Marking Enemy Positions

B-20. Target marking aids aircrews in locating targets the unit in contact desires them to attack. Ground commanders should provide the target mark whenever possible. To be effective, the mark must be timely, accurate, and easily identifiable. Target marks may be confused with other fires on the battlefield, suppression rounds, detonations, and marks on other targets. Although a mark is not mandatory, it assists in aircrew accuracy, enhances SA, and reduces risk of fratricide.

Marking by Direct Fire

B-21. Direct-fire weapons can deliver a mark. Although this method may be more accurate and timely than an indirect fire mark, its use may be limited by range and the visibility of the weapon’s burst effect. Aircraft may be used to deliver a mark. The preferred method is for aircraft to mark with phosphorous, high-explosive rockets, illumination, or lasers. A burst of cannon fire or a single rocket fired to the left or right of the target as a marking round may be an option. This method may alert the enemy but is a good way to verify the target with reduced risk of friendly casualties. Ground units may also mark targets with direct fire using tracers, M203 smoke rounds, or other means as coordinated by the unit.

INFRARED MARKING

B-22. IR pointers, as well as other IR devices, can be used to mark targets at night for aircrews that are using NVGs; however, aircrews using other NVDs—such as FLIR or thermal imaging system—may not be able to see the mark. Unlike laser designators, these IR devices cannot be used to guide or improve accuracy of aircraft ordnance. IR pointers may expose friendly units to an enemy with night-vision capability and should be used with caution. Ground units should initiate IR marks when the aircrew request “SPARKLE” and continue until the aircrew transmits “STOP” or the weapon hits the target.

Marking by Indirect Fire

B-23. Artillery or mortar fires are effective means of assisting aircrews in visually acquiring targets. Before choosing to mark by artillery or mortars, observers should consider the danger of exposing these supporting arms to enemy indirect-fire acquisition systems and additional coordination required. Marking rounds should be delivered as close to target as possible with smoke being the last round. Marking rounds are most effective when delivered within 100 meters of target, but those within 300 meters are generally effective enough to direct armed aircraft. If the situation requires a precise mark, observers or spotters can adjust marking rounds early ensuring an accurate mark is delivered. This action may, however, alert the enemy to an imminent attack.

Backup Marks

B-24. Whenever a mark is provided, a plan for a backup mark should be considered. For example, direct fire may be tasked to deliver the primary mark, while a mortar may be assigned responsibility for the backup mark.

B-25. Table B-2 suggests methods for identifying friendly forces and enemy targets.

Table B-2. Methods of marking friendly and enemy positions

METHOD	DAY	NIGHT	NVG	NVS	FRIENDLY MARKS	TARGET MARKS	REMARKS
Smoke	Go	No Go	Marginal	No Go	Good	Good	Easy identification. May compromise friendly position, obscure target, or warn of FS employment. Placement may be difficult because of terrain, trees, or structures.
Smoke (IR)	Go	Go	Go	No Go	Good	Good	Easy identification. May compromise friendly position, obscure target, or warn of FS employment. Placement may be difficult because of terrain, trees, or structures. Night marking is greatly enhanced by the use

Table B-2. Methods of marking friendly and enemy positions

METHOD	DAY	NIGHT	NVG	NVS	FRIENDLY MARKS	TARGET MARKS	REMARKS
							of IR reflective smoke.
Illumination, Ground Burst	Go	Go	Go	No Go	NA	Good	Easy ID. May wash out NVDs.
Signal Mirror	Go	No Go	No Go	No Go	Good	NA	Avoids compromise of friendly location. Depends on weather and available light. May be lost in reflections from other reflective surfaces such as windshields, windows, or water.
Spot Light	No Go	Go	Go	No Go	Good	Marginal	Highly visible to all. Compromises friendly position and warns of FS employment. Effectiveness depends on the degree of ambient lighting.
IR Spot Light	No Go	No Go	Go	No Go	Good	Marginal	Visible to all NVGs. Effectiveness depends on the degree of ambient lighting.
IR Laser Pointer (below .4 watts)	No Go	No Go	Go	No Go	Good	Marginal	Effectiveness depends on the degree of ambient lighting.
IR Laser Pointer (above .4 watts)	No Go	No Go	Go	No Go	Good	Good	Less effected by ambient light and weather conditions. Highly effective under all but the most highly lit or worst weather conditions. IZLID-2 is the current example.
Visual Laser	No Go	Go	Go	No Go	Good	Marginal	Highly visible to all. High risk of compromise. Effective, depending upon degree of ambient light.
Laser Designator	Go	Go	No Go	Go	NA	Good	Highly effective with precision-guided munitions. Restrictive laser-acquisition cone and requires LOS to target. May require precoordination of laser codes. Requires precision-guided munition or LST equipped.

TARGET MARKING BREVITY LIST

B-26. Table B-3 lists standard brevity terms.

Table B-3. Brevity list

Term	Meaning
Rope	Observer is circling an IR pointer around an aircraft to help the aircraft identify the friendly ground position.
Visual	Observer is sighting a friendly aircraft or ground position. Opposite of BLIND.
Blind	Observer has no visual contact with friendly aircraft or ground position. Opposite of VISUAL.
Contact	Observer— 1. Has sensor contact at the stated position. 2. Acknowledges sighting of a specified reference point.
Snake	Aircrew calls to oscillate an IR pointer about a target.
Sparkle	Observer acknowledges— 1. Air-to-surface target marking by IR pointer. 2. Air-to-surface target marking by gunship/FAC-A using incendiary rounds.
Tally	Observer acknowledges sighting of a target, aircraft, landmark, or enemy position. Opposite of NO JOY.
Steady	Aircrew calls to stop oscillation of IR pointer.
Stop	Aircrew calls to stop IR illumination of a target.
No Joy	Aircrew does not have visual contact with the target/bandit/landmark. Opposite of TALLY.

OTHER OPERATIONS

SPECIAL OPERATIONS

B-27. Training at home station with SOF may not be practical or available. Commanders must be aware SOF are probably in theater, but their activities may not be published. Establishment of a communications link with special operations units is essential when coordinating operations.

B-28. SOF are usually well trained in the use of all assets. Their expertise should make flow of coordination with them simple, but in some instances, the aviation force leader may have to use emergency coordination measures.

OPERATIONS WITH NONTRADITIONAL FORCES

B-29. Commanders must train their leaders and Soldiers to be flexible and prepared to conduct liaison with and support elements not traditionally included in home station training. These organizations may include the Central Intelligence Agency, Department of State, Drug Enforcement Agency, domestic and foreign police agencies, and indigenous forces. General checklists may be developed to address concerns. Often, these other agencies may not be aware of aviation capabilities. LNOs must be ready to advise and assist the supported element.

Emergency Coordination Measures

B-30. Aviators may be required to assist ground personnel who are not fully familiar with aviation assets. Key personnel who habitually handle coordination for aviation support may become casualties or simply not be available. These situations require close attention, careful communications, and initiative on the part of the aviator to place fire on targets or deliver other support as necessary. An attack pilot may have to assist in extracting personnel.

B-31. Pilots must ask appropriate questions of the requestor with emphasis on positive identification of location. Possibilities include the following:

- Where is ground unit’s position? What are the GPS coordinates? Are those coordinates verified with another GPS?

- Can ground unit mark its position with smoke, tracers, or other methods? (If smoke is used, aircrew verifies color after deployment.)
- What assistance does ground unit need? (FS, extraction, or resupply)
- Where is the target? What are the grid coordinates or relationship of the target to a readily identifiable natural or manmade feature?
- How far is the target from ground unit and in what direction? If the observer is not familiar with meters, aircrews ask the observer to try football or soccer field lengths estimating distances.
- What is the target? Is it personnel, vehicles, equipment, or buildings? What is the size of the enemy force, and what is it doing?

B-32. Aviators may have to fly helicopters near friendly troops to deliver ordnance onto the target. Factors reducing the potential for fratricide include the following:

- Precision-guided munitions.
- FSCMs.
- Planned or hasty coordination and control measures.
- Knowledge of ground tactical plan.
- Knowledge of exact location of friendly troops.
- Composition of friendly forces (number and type of vehicles, types of uniforms if nonstandard or coalition/host nation forces—Army or police).
- Knowledge of exact location of aircraft.
- Positive identification of targets.
- Familiarity between supported unit and aviation unit.

MISSION TRAINING

B-33. Integration starts at home station with—

- Development of common SOPs among aviation and ground maneuver units.
- Habitual combined training, including battle drills, helping all team elements maintain awareness of locations and needs of other elements.
- Integration of ARB into ground maneuver unit's STX/field training exercise (leading to fully integrated livefire training exercises).

B-34. Training, procedural standardization and familiarity of team members greatly accelerates planning and coordination, especially in unfamiliar environments. A team built in this manner establishes battle efficiency sooner and maintains a higher tempo of combat operations. Familiarity and compliance with joint procedures are essential in allowing seamless integration with other services' ground and air units.

B-35. Commanders must insist on a high degree of combined arms training with habitually supporting units in the manner they are expected to fight. Air and ground units regularly train and execute battle drills together making coordination and reaction in combat instinctive. Although aviation may not be available for every exercise, ground maneuver units need to understand how to effectively integrate all aviation systems in their operations. Commanders can further ensure the effective integration into ground maneuver through OPDs, NCOPDs, and capabilities and limitations briefings with the ground maneuver units.

B-36. When units have not been able to create the desired habitual relationship, planning and coordination processes will be longer and more detailed. Rehearsals are essential for success. In-country training exercises should also be accomplished whenever possible. The probability of mistakes is increased unless coordination, planning, rehearsals, and training are conducted. Commanders must apply risk-management procedures throughout planning and execution.

MISSION PLANNING

B-37. Mission planning encompasses mission training, rehearsal, and execution. During planning, a company or troop commander analyzes the OPORD using TLP (identifying specified, essential and implied

tasks), visualizes how the operational environment will look at various stages, develops a plan, and prepares the unit to conduct the operation. During split-based operations, platoon leaders and section leaders must utilize these same TLP prior to conducting operations supporting the maneuver commander's intent.

B-38. Training exercises validate planning, training, and rehearsal, while the outcome of these exercises tells the commander where to place emphasis for future training and where to focus sustainment training (figure B-1).

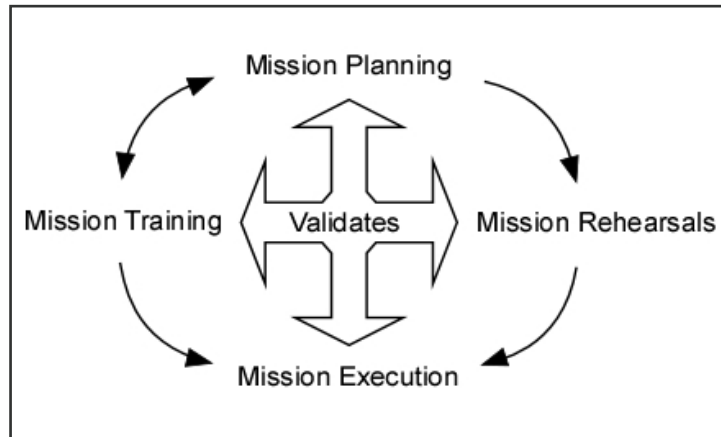

Figure B-1. Mission planning through execution cycle

B-39. Mission recovery ensures readiness for subsequent missions. Recovery includes munitions reconfiguration, refueling, maintenance, CP movement, and crew changes.

B-40. The minimum information required by an Army aviation team to ensure accurate and timely support includes—

- Situation including friendly forces' location, enemy situation highlighting known ADA threat in the AO, mission request, and tentative EA coordinates.
- Updating brigade- and battalion-level graphics via MCS, AMPS, or radio communications. Updating critical items—such as LOA, fire control measures, and maneuver graphics, ensures better integration into the friendly scheme of maneuver.
- FS coordination information including location of DS artillery and organic mortars, and call signs and frequencies.
- Ingress/egress routes into the AO, including PPs into sector or zone, and air routes to the HA or LZ.
- Call signs and frequencies of the battalion in contact, down to the company in contact; air-ground coordination must be done on command frequencies to provide SA for all elements involved.
- GPS and SINCGARS time coordination; care must be taken to ensure all units are operating on the same time. All units should use GPS time which is the most accurate. A common error is for some ground units and aviation operations centers to set SINCGARS time by ANCD/CYZ 10 instead of GPS time. This results in ground and air communication failure due to time/synchronization error.

B-41. Digital transmission of information, such as coordinates, is faster and more accurate, if available. Voice communications are necessary to verify information and clarify needs and intentions.

LIAISON WITH THE GROUND MANEUVER FORCE

B-42. The BAE is a planning and coordination cell whose major function is incorporating aviation into the ground commander's scheme of maneuver. The BAE focuses on providing employment advice and initial planning for aviation missions, UAS, airspace planning and coordination, and synchronization with the ALO and effects coordinator. The BAE also coordinates directly with the CAB or supporting aviation TF for detailed mission planning. The liaison demands on aviation units are reduced by implementation of the BAE.

B-43. Although the BAE will conduct many of the functions traditionally performed by LNOs, aviation LNO teams will remain a critical part of the process and must be staffed appropriately. While the members of the BAE work directly for the BCT commander as permanent members of his staff, aviation LNO teams represent the supporting aviation TF at a designated maneuver headquarters only for the duration of a specific operation. Effective employment of LNOs is imperative for coordination and synchronization. Often aviation LNO teams will coordinate with the BAE and then proceed to a supported ground maneuver battalion. An example would be an aviation LNO team in support of an infantry battalion performing an AASLT to seize a key piece of terrain as part of a mechanized BCT scheme of maneuver.

B-44. Aviation LNOs must embody competence and credibility, and act as skillful representatives for their respective aviation TFs. A commander must exercise extreme care in choosing his LNOs since his unit is judged by their performance. The LNO must be capable of changing focus and approach depending on location and who he is supporting at the time. Above all, the LNO must be knowledgeable and project an ambitious attitude to the supported unit.

B-45. LNO teams maintain and provide current—

- Aviation unit locations.
- Aircraft/equipment status.
- Crew availability and fighter management cycle status.
- Class III/V status.
- METL training status.
- Continuous updates to the aviation commander and staff on the BCT's plan.

B-46. See TC 1-400 for more information on BAE/liaison operations.

DECONFLICTION

B-47. Deconfliction is a continual process for ground, aviation, and other supporting units. During planning and execution, aviation units must deconflict their operations with friendly units:

- Indirect fires, including mortars and possibly NSFS.
- CAS.
- UAS.
- ADs.
- Smoke operations.
- Other internal aviation operations.
- Nonorganic aviation operations.
- Other services' delivery systems such as supply drops.

SECTION II – FRATRICIDE PREVENTION

GENERAL

B-48. Air and ground assets require effective integration in conducting operations successfully and minimizing potential for fratricide and civilian casualties. Integration starts at home station with

implementation of effective tactical SOPs, habitual relationships, and training. It continues through planning, preparation, and execution of the operation.

FUNDAMENTALS

B-49. Fratricide is the employment of friendly weapons and munitions, used with the intent to kill enemy forces or destroy its equipment or facilities, which results in unforeseen and unintentional death or injury to friendly, neutral, or noncombatant personnel. Fratricide is a type of accident and is a real and grim consequence of war. Its effects, spreading deep within a unit, can be devastating.

CAUSES OF FRATRICIDE

B-50. Contributing factors to fratricide include but are not limited to—

- Incorrect target identification.
- Incomplete planning and coordination.
- Improper clearance of fires.
- Equipment failure or improper procedures.
- Inadequate graphic control measures.
- Poor land navigation.
- Loss of communications.
- Position-reporting errors.

B-51. Weapons systems can detect, engage, and destroy targets at maximum range. However, weapons-sighting equipment cannot provide high resolution of targets at extended ranges, especially during limited-visibility conditions. The increasing use of common equipment by allied and hostile nations elevates the probability of fratricide.

FRATRICIDE RISK CONSIDERATIONS

B-52. There are two types of risk—losing men and equipment to accomplish the mission and choosing a COA that may not be successful or may succeed but fail to achieve the desired effect. A commander must take such risks with prudence.

B-53. Prudent risk taking emphasizes operational functions with the proper balance of administrative functions; for example—

- Understanding capabilities and limitations of units and components.
- Understanding task, purpose, and scheme of maneuver for ground units.
- Understanding the enemy, identifying weaknesses, and creating opportunities to exploit enemy weaknesses.
- Pursuing actions that gain or retain the initiative.
- Planning for a mission or unit training.
- Training with supporting branches (joint and combined arms).
- Participating, supervising, and observing unit training.

B-54. The format for fratricide risk factors in figure B-2, page B-12, and figure B-3, page B-14, parallels the five-paragraph OPORD. The considerations/factors are essential to fratricide reduction and structured where they would likely appear in the OPORD. This is neither a change nor an addition to the OPORD format.

PARAGRAPH 1: SITUATION

a. Enemy Forces:
Equipment and uniform similarities.
Language.
Deception capabilities and past record.
What similarities could lead to fratricide?
Location.

b. Friendly Forces:
Similarities or differences (allied forces language, uniform, and equipment [combined operations]).
Differences in US service's equipment and uniform (joint operation).
What similarities could lead to fratricide?
What differences could prevent fratricide?
Deception plan.
Location of unit and adjacent units (left, right, leading, follow-on).
Location of neutrals and/or noncombatants.

c. Attachments/Detachments:
Do attached elements know above information?
Do gaining units supply above information to detached elements?

Own Forces:
Status of training (individual, crew, unit) proficiency.
Fatigue (at time of the operation, sleep plan, and so on).
Acclimatization to area of operations.
Equipment (new, old, and mix; status of NET).
MOPP requirements.

Weather:
Visibility (light data and precipitation).
Hot, cold (effect on weapons, equipment, and Soldiers).

Terrain:
Topography and vegetation (for example, urban, mountainous, hilly, rolling, flat, swamp/marsh, prairie/steppe, jungle, dense forest, open woods).
OAKOC.

PARAGRAPH 2: MISSION
Is this mission, with associated tasks and purposes, clearly understood?

PARAGRAPH 3: EXECUTION

a. Task Organization:
Has unit worked under this organization before (familiarity)?
Are SOPs compatible with the task organization (especially with attached units)?

Uniform and Equipment:
Are special markings/signals needed for positive identification (for example, cat's eyes, chemical lights, panels, and so on)?
What special weapons and/or equipment are to be used?
Do they look/appear like enemy weapons and/or equipment?

b. Concept of Operations:

- 1. Maneuver.**
Are main and supporting efforts identified to ensure awareness of greatest fratricide danger?
- 2. Fires. (direct and indirect).**
Are priorities of fires identified?
Target list(s).
Fire execution matrix/overlay.
Location of denial areas (minefields/FASCAM) and contaminated areas (such as ICM, CBRN).
Location of all supporting fires targets identified in OPORD/OPLAN (overlays).
Are aviation and CAS targets clearly identified?
Direct fire plan.
FPF.
Sector limits (check/verify).
- 3. Engineer.**
Barrier Breaching:
Are friendly minefields, including FASCAM and ICM contaminated areas, known?
Are obstacles, along with approximate time for reduction/breaching, identified?
- 4. Tasks to Each Subordinate Unit:**
Are friendly forces identified, as appropriate, for each subordinate maneuver element?
- 5. Tasks to Maneuver Support and Sustainment Units:**
Are friendly forces identified to maneuver support and sustainment units?
- 6. Coordinating Instructions:**
Rehearsal:
Will one be conducted; is it necessary?
Are direct and indirect fires included?
Is a backbrief necessary?

Figure B-2. Fratricide risk factors

Constraints and Limitations:

Are appropriate control measures clear and in the OPORD/overlay?

Control measures might include all or some of the following: AA, attack position, LD, axis of advance/avenue of approach/direction of attack, PLs, objective(s), movement times, RFL, FSCL, zone of engagement, limits of advance, MSR, coordination points, LP/OP, challenge and password, and so on.

Are these control measures known by everyone who has a need to know?

What is the plan for using control measures to synchronize the battle and prevent fratricide?

Target/vehicle identification drills.

What is the immediate action drill/signal for "Cease Fire"/"I'm Friendly" if element comes under unknown/unfriendly fire?

Is there a back-up action?

Is guidance included in handling dud munitions (such as ICM and CBU's)?

PARAGRAPH 4: SERVICE SUPPORT

Ensure trains location(s) and identification marking(s) are known by everyone.

Ensure medical/maintenance personnel know routes between trains and units.

PARAGRAPH 5: COMMAND AND SIGNAL

a. Command:

Where is the location of the command and key staff?

What is succession of command?

b. Signal:

Do instructions include signals for special and emergency events?

Do instructions include how to identify ourselves to aircraft?

Do instructions include back-up for code words and visual signals for all special and emergency events?

Are SOI distributed to all units with a need to know (such as higher, owner, left, right, leading, and following units)?

Figure B-2. Fratricide risk factors (continued)

FACTORS		ASSESSED RISK LEVEL		
		LOW X 1	MEDIUM X 2	HIGH X 3
MISSION	UNDERSTAND PLAN Commander's Intent Complexity Friendly Situation ROE BACKBRIEFS CONTROL MEASURES Command Relationships Audio Visual Graphs SOPs LOs Location-Navigation	CLEAR SIMPLE CLEAR CLEAR THOROUGH ORGANIC LOUD/CLEAR WELL-SEEN STANDARD STANDARD PROFICIENT SURE		FOGGY COMPLEX UNCLEAR UNCLEAR HASTY JOINT/HASTY JAMMED OBSCURED NOT UNDERSTOOD NOT USED UNTRAINED UNSURE
ENEMY	ENEMY SITUATION COMBAT VEHICLE RECOGNITION State of Training Vehicle Appearance to US Vehicles Friendly Units Enemy Units EXPLOIT ENEMY WEAKNESSES Neutralize Strengths CHALLENGE/PASSWORD DISCIPLINE	KNOWN TRAINING SIMILAR DIFFERENT EFFECTIVE HIGH USE		UNKNOWN UNTRAINED DIFFERENT SIMILAR INADEQUATE LOW USE
TROOPS	TRAINING FITNESS MORALE UNIT PROFICIENCY HABITUAL RELATIONSHIPS INSPECTIONS BUDDY SYSTEM SAFETY DISCIPLINE	MOS QUALIFICATION RESTED/FIT HIGH TRAINED YES CONDUCTED USED HIGH		UNTRAINED TIRED/BATTLE WEARY LOW UNTRAINED NO NOT CONDUCTED NOT USED LOW
TERRAIN	SEASONAL HAZARDS DETAILED NAVIGATION PLAN INTERVISIBILITY OBSCURATION BATTLE TEMPO POSITIVE TARGET ID	GOOD WEATHER REDUNDANT NAV AIDS GOOD NONE SLOW 100 PERCENT		EXTREME WEATHER NO NAV AIDS POOR EXTREME FAST 0 PERCENT
TIME	PLANNING TIME FULL TLP REHEARSALS RECONNAISSANCE SLEEP PLANS	ADEQUATE FULL FULL THOROUGH GOOD		INADEQUATE ABBREVIATED NONE NONE POOR
*OVERALL FRATRICIDE ASSESSMENT		** 37-61	57-91	87-111
* Commander may use numbers as the squadron decreases. ** In this example, each risk factor counts as one. These numbers are multiplied by the value assigned to each column (LOW-1, MEDIUM-2, HIGH-3). By weighing each factor, an overall score can assist in determining the risk.				

Figure B-3. Risk reduction and/or fratricide prevention measures

SECTION III – BRIGADE COMBAT TEAMS

ORGANIZATION

B-55. Maneuver BCTs are the Army's basic instrument of tactical execution. Figure B-4, page B-15, provides an overview of the three types of maneuver BCT organization (refer to FM 3-90.6).

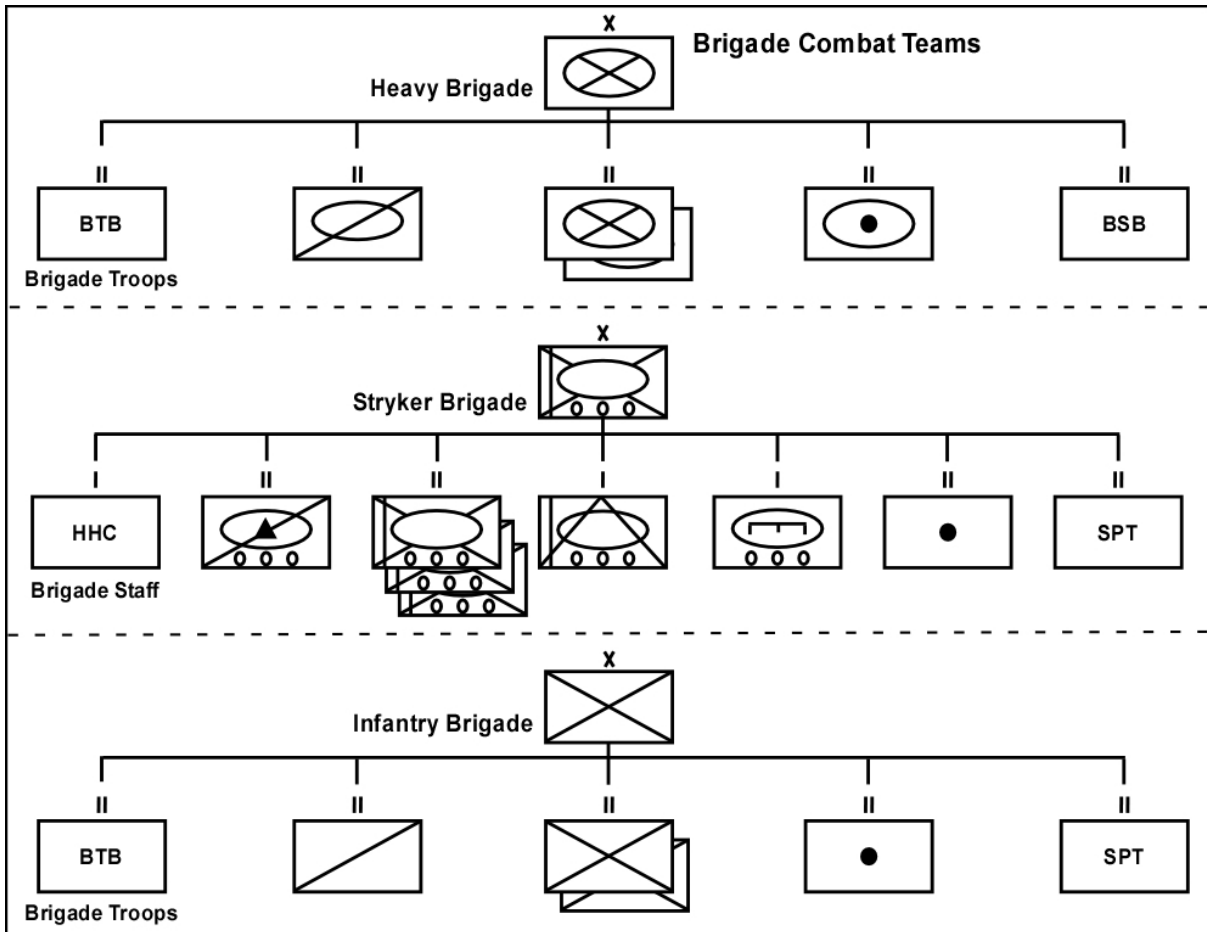

Figure B-4. Maneuver brigade combat teams

HEAVY BRIGADE COMBAT TEAM

B-56. The heavy brigade combat team (HBCT) reduces complexity of deployment planning and replaces many variations of divisional armored and mechanized brigades. It contains combined arms components normally required to rapidly achieve tactical overmatch in a single formation. Robust enough to fight with or without external support for limited periods, the HBCT can fight “off the ramp” across the full spectrum of operations when tactically loaded.

STRYKER BRIGADE COMBAT TEAM

B-57. The SBCT can be deployed rapidly and sustained by an austere support structure for up to 72 hours of independent operations. The SBCT conducts operations against conventional or unconventional enemy forces in all types of terrain and climate conditions and all full spectrum operations. The SBCT has personnel strength of approximately 3,500 Soldiers and is preconfigured in ready-to-fight combined arms packages. The design includes embedded unit-based capabilities such as military intelligence, signal, engineer, antitank, artillery, and sustainment elements. This design allows the SBCT to fight combined arms down to company level creating combat power with flexibility in complex and urban terrain.

INFANTRY BRIGADE COMBAT TEAM

B-58. The infantry brigade combat team (IBCT) reduces complexity of deployment planning and replaces many variations of divisional light, assault and airborne brigades. It contains combined arms components

Appendix B

normally required to forcibly enter an AOs and hold key objectives for a short period of time. Robust enough to fight without external support for limited periods, IBCT can fight “off the ramp” across the full spectrum of operations when tactically loaded.

Appendix C

Joint Air Attack Team Operations

This appendix discusses the fundamentals, planning considerations, and execution of JAAT. Included is a description of the FSE's responsibilities and extraneous considerations necessary for synchronization with other military services. Multiple service collaboration and utilization of FW and rotary aircraft are emphasized; both are necessary components to reduce risk for successful support of the JAAT mission.

SECTION I – FUNDAMENTALS

C-1. A JAAT operation is a coordinated attack by rotary and FW aircraft, normally supported by artillery or NSFS. Ground or airborne EW systems may also support the JAAT. JAAT operations support the joint force commander (JFC) in offensive and defensive operations day or night. JAAT references include, but are not limited, to—

- FM 3-09.32 (Marine Corp reference publication 3-16.6A, Naval Weapons publication 3-09.2, and Air Force technical training publication [I] 3-2.6).
- FM 90-21 (Marine Corp reference publication 3-23A, Naval Weapons publication 3-01.03, and Air Force technical training publication [I] 3-2.10).
- JP 3-09.1.
- JP 3-09.3.
- JP 3-60.

C-2. JAAT operations involve participation of different force components with varying operating procedures; they are by nature inherently complex and high risk operations. Therefore, execution procedures must be as simple as possible and lie within the capabilities and understanding of the players involved. FM 3-09.32 assists the JAAT commander, mission commander, and support personnel identify areas of consideration for preplanned or immediate JAAT execution. FM 3-09.32 contains procedures proven by exercise and combat experience that can reduce overall risk to the forces involved.

COMMAND RESPONSIBILITIES

C-3. Normally, the maneuver force commander, within an assigned operational area, is responsible for determining when a JAAT is necessary, but any commander (air, land, or maritime) may request a JAAT. In this publication, the terms maneuver force commander and maneuver commander are representative of any commander (air, land, or sea) with overall command responsibilities within an AO.

C-4. Designation of a mission commander occurs after coordination between the requesting commander and supporting commanders. The mission commander is responsible for the planning, coordinating, and executing the JAAT. The mission commander has TACON of JAAT assets to support the commander's battle plan.

ROTARY-WING ELEMENT

C-5. Rotary-wing aircraft provide firepower, target acquisition, designation, and mission coordination to the JAAT. The Army provides AH-64A/D and OH-58D attack reconnaissance rotary-wing aircraft for JAAT operations. The Marine Corps could provide rotary-wing attack aircraft, specifically AH-1W Super Cobra or AH-1Z King Cobra. The Navy and Air Force do not have rotary-wing attack aircraft.

C-6. As a minimum, Army helicopters operate in teams and are organic to company units. These units usually employ to provide continuous coverage for the JAAT but may be employed as part of a battalion-sized flight totaling as many as 24 rotary-wing aircraft to achieve massed fires on the target. When compared to day time operations, Army rotary-wing aircraft flying NOE are less vulnerable to enemy ADs requiring visible acquisition or aiming at night; therefore, operations are preferably conducted at night.

FIXED-WING AIRCRAFT

C-7. FW aircraft employ CAS procedures and tactics, described in FM 3-09.32 during JAAT operations. In addition to exercising control of the aircraft, the forward air controller (airborne) (FAC [A]) may also provide air reconnaissance, surveillance, target marking, and communications.

AIR FORCE

C-8. Air Force CAS aircraft are capable of performing JAAT operations; however, only qualified crewmembers are authorized to participate in JAAT. Air Force members execute JAAT according to AFI 11-214 and ACCR 55-26 following CAS procedures detailed in FM 3-09.32.

NAVY

C-9. All tactical FW Navy aircraft are capable of supporting JAAT operations. (EA-6B aircraft may be able to support JAAT operations with their specific mission roles.) All F-14 squadrons have FAC (A) qualified aircrews who routinely train in JAAT operations, including control and coordination of FW aircraft, rotary-wing aircraft, and indirect FS integration and deconfliction. Each air wing typically deploys with 12 to 16 FAC (A) qualified aircrew. Navy FAC (A) aircrew train routinely with Army and Marine Corps attack helicopters in JAAT operations. All other Navy tactical FW aircrews have limited training in JAAT operations and are generally exposed to a JAAT once or twice a year.

INDIRECT FIRE SUPPORT

C-10. Indirect FS (artillery, mortars, and/or NSFS) are planned to support and augment the firepower of JAAT operations. Normally indirect FS provides SEAD and target marking. Additionally, indirect FS may provide close fires, fires in depth, and counterfire. JAAT indirect FS requirements generally use the same request, planning, coordination, control, and execution procedures as ground operations. The Army and Navy provide indirect FS. NSFS can be referenced in FM 3-09.32 and NWP 3-20.32.

ARMY

C-11. The FSE of the maneuver commander requesting or ordering the JAAT plans for, coordinates, and oversees the execution of FS. The mission commander contacts the FSE if the mission requires additional FS or other assistance. The FSE coordinates the requested support. If a maneuver commander requests or orders a JAAT to take place in another commander's AO (division JAAT in brigade AO), then that commander's FSE must coordinate with the FSE in whose AO the JAAT is to take place.

NAVY

C-12. NSFS for Army units is coordinated through the Marine Corps air and naval gunfire liaison company (ANGLICO). The ANGLICO division and brigade liaison teams are normally attached to the FSE of the supported division or brigade. These teams are responsible for planning, liaison, control, coordination, and employment of supporting arms.

SECTION II – PLANNING

OPERATIONAL PLANNING CONSIDERATIONS

C-13. The JAAT offers the commander unique strengths. JAAT operations provide mutual support with an increase in each member's survivability and a capability to mass combat power through diverse ordnance and employment procedures. This includes reconnaissance, surveillance, and communications redundancy, combined with an enhanced force protection capability.

C-14. The maneuver commander has the responsibility for integrating JAAT missions into the battle plan. The requesting commander's staff plans for, organizes, and coordinates JAAT operations to support this plan. Successful JAAT execution depends upon careful mission analysis, coordination, and planning.

MISSION

C-15. The planning process begins during mission analysis when the requesting commander/staff determines employing JAAT will assist in accomplishing the mission. JAAT EA development and distribution of all fires must be included when developing the plan. Since each member of the JAAT retains their own C2 system, mission planning must be a coordinated effort. Constant coordination is desired between requesting commander, mission commander, FAC (A), fixed- and rotary-wing representative, TACP, FSE, and the air support operations center (ASOC). As elements of the mission change, all members must be informed to adjust accordingly.

INTELLIGENCE PREPARATION OF THE BATTLEFIELD

C-16. A key ingredient to the success of the JAAT intelligence effort is the continuous collection and appropriate dissemination of information. The mission commander requires continuous information on the objective before, during, and after the mission. The G2/S2 is responsible for the IPB. The G2/S2 identifies the target, target area, NAI, enemy defenses, enemy and friendly DPs, and time window when the target will be active in the EA. Timely JAAT employment is determined by identifying key enemy events that are target indicators of the enemy's COA and may act as the trigger for execution of a preplanned attack. The G2/S2 coordinates the collection effort, refines the information, and ensures the information is received by planning staffs and supporting units. The IPB process is continuous, occurring before, during, and after the JAAT to ensure the most up-to-date information on the enemy's activity is available during the planning and execution phases.

THREAT AIR DEFENSE ENVIRONMENT

C-17. The mission commander considers how various elements of the JAAT assist to neutralize or suppress the enemy AD.

TERRAIN ANALYSIS

C-18. Planners ensure the most effective use of terrain. Terrain analysis is conducted to identify EA(s), ground and air avenues of approach, and gaps in threat AD due to terrain. Terrain analysis also aids in determining employment methods and selecting ingress and egress routes.

WEATHER

C-19. Weather conditions may limit capabilities of aircraft and weapons. High humidity, fog, and precipitation reduce visibility and effectiveness of IR devices and interfere with lasers. Low ceilings also affect the range and employment of laser guided Maverick and Hellfire missiles, since the trajectory may put the missile in the clouds. High temperature and pressure can limit the range and weapons payload of aircraft. High or gusting winds effect accuracy of indirect weapons employment and can limit the use of rotary-wing aircraft. If weather forces the cancellation of one or more JAAT components, a contingency plan derived.

ASSETS

C-20. The commander/staff determines what assets are required and available to accomplish the JAAT. Assets considered include combat air patrols (CAPs), tankers, UAS, Airborne Warning and Control System (AWACS), airborne battlefield command and control center (ABCCC), FW aircraft, reconnaissance/collectors, rotary-wing assets, and EW assets.

TIME AVAILABLE

C-21. The more complex the JAAT mission the more planning time required. A planning horizon of 36 hours usually allows time for a complete joint ATO cycle. Anything less can be planned but may not be in the joint ATO. ATO requirements are discussed in JP 3-30. Units include requests for fighter and reconnaissance aircraft early in the planning process. A staff with prior JAAT training and working SOPs can significantly reduce the amount of planning needed to conduct a successful operation allowing an immediate or spontaneous JAAT be accomplished with minimum coordination. A time, location, and common frequency for all participants may suffice in an immediate or spontaneous JAAT situation.

SYNCHRONIZATION

C-22. A JAAT operation is synchronized at two levels. At the first level, the JAAT operation must be synchronized with the overall operation. The second level involves synchronization of various elements during execution of the JAAT operation. The requesting commander is responsible for ensuring synchronization at the first level and the mission commander is responsible for ensuring synchronization at the second level. Achieving both levels of synchronization requires an understanding of individual elements of the JAAT.

OPERATIONAL ENVIRONMENT CONSIDERATIONS

C-23. When planning a JAAT operation, the proximity of friendly forces must be considered. The requesting commander defines close proximity to friendly forces, and special emphasis is placed on preventing fratricide. JAAT operations beyond the fire support coordination line (FSCL) must be coordinated with the joint air operations center (JAOC) through the battlefield coordination detachment (BCD).

C-24. The EA is an area the commander intends to fix and attack the enemy force with massed fires of all available weapons. EAs are terrain oriented control measures that focus the JAAT fires. Fire distribution planning ensures effective fires throughout the EA. To develop an EA, the IPB process determines where the enemy is currently located, where they will go, where best to engage them, and when they will be there. The commander selects the EA based on the IPB. The EA then becomes the focus for JAAT planning. JAAT assets are coordinated and integrated to destroy enemy in the EA through massed firepower.

C-25. Once the EA is developed, the mission commander develops the fire distribution plan to avoid redundancy, minimize risk of fratricide, and maximize the effects of long-range weapon systems. Planners must establish C2 procedures for conducting the attack. A well-written and understandable SOP reduces C2 coordination requirements. Every effort is made to involve each community in the planning as early as possible. Face-to-face meetings assist in establishing the team part of JAAT.

C-26. Communications among JAAT participants is key to mission effectiveness. Designing a JAAT communications plan and disseminating it early to participants ensures timely radio contact. Once developed, the communications plan is coordinated with the mission commander. Considerations include using CAS coordinator (airborne)/FAC (A) as a radio relay; availability of Have Quick and secure radios; and providing all components with the appropriate frequency and authentication. Additionally, friendly force AD units operating along ingress/egress routes and in the AO must be informed of JAAT missions occurring in the area.

FIRE SUPPORT

C-27. The maneuver commander, TACP, effects coordinator (ECOORD) (brigade and above)/fire support officer (battalion and below), G3/S3, G2/S2, A2C2 element, Army aviation LNO, and mission commander work together ensuring adequate FS for the JAAT.

INDIRECT

C-28. Indirect FS can greatly increase survivability of JAAT aircraft while promoting destruction of the enemy. Furthermore, it can be used to begin the attack, suppress or destroy enemy AD, force armored vehicles to deploy, and create confusion for the enemy.

CLOSE

C-29. FS can attack targets in the EA to assist the JAAT. Planners should consider the effects of close fires as it may obscure the target area, decreasing pilot's ability to acquire targets. Using precision-guided artillery munitions to engage HPTs can minimize obscurants. However, precision-guided munitions require detailed planning and coordination with observers, artillery firing units, and the mission commander.

COUNTERFIRES

C-30. Rotary-wing attack reconnaissance aircraft are vulnerable to enemy FS during the JAAT operation. Friendly indirect FS assets are allocated to counter the enemy FS capability. Counterfire radars are coordinated early to facilitate cueing and assist aviators in identification and selection of rotary-wing BPs.

TARGET MARKING/DESIGNATION

C-31. Target acquisition and identification are critical to effective JAAT operations. Three main techniques of marking a target are a marking round from any of the JAAT elements; laser designation; and IR pointer for night operations.

C-32. All FS ground laser designators are used to designate targets for laser guided munitions (Hellfire missiles, laser guided bombs) and/or laser spot tracking devices. Several FS assets, such as Army fire support teams and combat observation and lasing teams, Marine forward observer teams/shore fire control parties, and FAC, could also be made available. Laser-equipped fixed- and rotary-wing aircraft also provide laser designation and calls for fires during day or night.

C-33. When using multiple lasers in the same area, laser pulse repetition frequency codes must be coordinated. During planning, the laser geometry must be coordinated to allow best acquisition by laser-guided weapons and aircraft laser spot trackers (LSTs). In addition, laser geometry should exclude the designator from the field of view for laser-guided weapons and LST. A laser employment plan is part of any mission including target designation, particularly multiple lasers.

C-34. For operations involving night vision devices, IR pointers may be used to mark/designated targets. See JP 3-09.3 for a more detailed discussion of night friendly position and target marking devices.

SOURCES OF JOINT AIR ATTACK TEAM FIRE SUPPORT

C-35. Sources of artillery support vary from brigade to division to corps level. At brigade, indirect fires may be available from the DS or reinforcing FA battalion or NSFS. Mortars and electronic attack support may also be coordinated through the BCT S3 and FSE. At division and corps, indirect fires are provided by FA battalions assigned a GS or GS-reinforcing mission. The division or corps G3 and FSE coordinates for NSFS when available. Mortar indirect FS is normally not available for tasking at division and corps.

C-36. During rotary-wing movement to contact, the FW element of the JAAT may be capable of providing additional threat information and SEAD for the attack helicopter component. Due to their higher operating altitudes and sensors, FW aircraft can often detect AD threats quicker than the attack helicopter force. Actual engagement of these threats is coordinated by the mission commander, as helicopters offer

significant advantages in attacking some SEAD targets while FW aircraft can successfully engage others. If specific AD systems are in the area, it may be possible to preplan mutually supporting SEAD actions. Other forms of dedicated SEAD should be considered first, however, since time and fuel may be a limiting factor for the JAAT participants. Electronic countermeasures pods carried by some FW strike aircraft are capable of limited jamming in support of other aircraft. When possible, JAAT operations are conducted concurrently with theater level J-SEAD operations, thereby benefiting from airborne jamming and defense suppression platforms operating in the same area.

C-37. J-SEAD operations can enhance survivability for JAAT elements operating in the EA as well as during the ingress/egress phases. The priority of initial observed indirect fires is to suppress enemy AD systems. Priority of initial rotary-wing fires is to suppress remaining enemy AD systems to protect themselves and FW aircraft. J-SEAD assets are employed according to mission objectives and system capabilities. Suppression is accomplished through lethal or nonlethal means or a combination of both. Destructive means are cumulative and employ direct and indirect fire weapons. Disruptive means temporarily neutralize enemy ADs. Ground, air, and naval standoff jamming should be part of the overall battle plan. For a more detailed discussion of J-SEAD operations refer to JP 3-01.4.

C-38. AD threat suppression is provided while friendly aircraft ingress, attack, or egress the EA. During the JAAT, enemy ADA can be neutralized. Helicopters accompanying lead enemy attack elements constitute a threat to the JAAT. The ability to rapidly suppress these threats is critical. While rotary- and FW aircraft react quickly, consideration is given to indirect FS assets that can execute rapidly by using preplanned targets. The asset allocation decision should be made early and take into account such factors as reaction time, weapons effects/duration, and economy. Most ADA can be neutralized or suppressed by observed fire using dual purpose improved conventional munitions or high explosive projectiles with variable time fuses.

PLANNING GUIDELINE

C-39. Effective preplanned JAAT operations depend on the IPB, resources available to conduct the JAAT, and time needed for staff to plan the operation. Table C-1 provides a good starting point for JAAT planning.

Table C-1. Joint air attack planning guideline

Commander's guidance	EA
Friendly situation	Success criteria
Enemy situation	Tactics and attack options
Success criteria	Firepower timing
Intelligence/weather	FSCM
Collection plan/products request	Aircraft positioning and EA flow
Plan for updates before launch and en route	Ordnance trajectory
Enemy vulnerabilities, possible COAs	Fragmentation/illumination effects
Enemy air threat/type/location (including air and surface means)	Control points and ABF/BPs
Type of targets and size	Ingress/egress routes
Target priorities	Friendly FS locations and capabilities
Target activity	Provisions for SEAD/J-SEAD
Assets/weapons-to-target/environment match	Friendly AD artillery weapons coordination
Weather	Locations of other friendly units

Table C-1. Joint air attack planning guideline

Sensor employment plan Alternate targets/contingency plans Electro-optical tactical decision aids Mission abort criteria/notification procedures	Timing options TOT or time to target (TTT) methods Attack methods Target area mechanics/geometry
C2	Target reference point
Communications (frequencies, Have Quick procedures, and authentication) EW considerations. Lost communications procedures Egress/return to force procedures ROE/training rules Risk management PR considerations	Target sort Laser employment plan Target marking options Disengagement considerations Mutual support Fires Sensor support Communications relay
Critical information flow	PR Collection of BDA

ARMY/AIR FORCE COMPONENT

C-40. When adequate planning time exists (normally a minimum of 36 hours), a commander requests a JAAT with an air support request message (FM 101-5-2, message number A020). The request states the JAAT mission to ensure availability of aircraft and pilots qualified to conduct JAAT operations. An Army request for JAAT is processed through Army FS channels up through corps for approval. The Commander Army Forces headquarters consolidates and prioritizes air support requests received from corps and subordinate units and forwards them to the BCD at the JAOC. At the JAOC, air requests from all components are considered and those with sufficient priority are included in the ATO. Simultaneously, the ALO assists the commander in planning the operation. Air Force request for a JAAT is considered at the JAOC with the BCD in a similar manner.

IMMEDIATE FIXED-WING REQUEST

C-41. When preplanning time is not available to submit the request in time for publication in the ATO, the TACP submits an immediate air support request, DD Form 1972 (Joint Tactical Air Strike Request), through the Air Force air request net directly to the ASOC at corps. The TACPs at intermediate levels monitor and inform corresponding commanders of the requests. They are allowed a designated time interval (theater specific, normally 10 minutes) to consider disapproving the mission request. A lack of response during the designated time translates into approval (silence is consent). Once the allotted time has expired with no disapproval, the mission is considered valid at those levels. The ASOC forwards the request to the G3 for approval. If approved, the ASOC tasks available on-call FW aircraft to support the request. If the ASOC has no FW available it can, with Army concurrence, divert sorties from lower priority targets or request support from lateral or higher commands. The requesting TACP remains the point of contact for mission information. Personnel at corps level and below for Army and ASOC level and below for Air Force have key planning responsibilities for employment of a JAAT.

NAVY COMPONENT

C-42. Navy FW aircraft supports JAAT operations when tasked by the joint force air component commander (JFACC) or other theater air component commanders. All Navy tactical air wings deploying to a theater of operations are capable of supporting JAAT operations. Since naval forces are not commanding or directing JAAT operations, any Navy aircraft tasked with supporting JAAT operations falls under the TACON of the unit responsible for the JAAT. A deployed carrier air wing (CVW) commander can provide augmentation personnel to the JFACC, if established, as required and directed by higher authority.

C-43. The deployed CVW commander ensures all air wing personnel committed to a hostile environment are familiar with tactics employed for JAAT operations. Subordinate commanders ensure their personnel are familiar with JAAT tactics and capable of meeting individual responsibilities.

C-44. The CVW commander supports JAAT operations when excess sorties are available. Any aircrew tasked to support JAAT operations falls under subordinate control of the appropriate air combat element (ACE) commander in the operation. The designated FAC (A) aircrew has primary responsibility for air wing training and execution of JAAT support. Whenever possible, this aircrew plans and leads any JAAT support requested or tasked by higher authority. The functions and capabilities of these FAC (A) aircrews are aerial reconnaissance, radio relay, control and coordination of fixed- and rotary-wing aircraft individually or as combined arms. This includes coordination and control of SEAD to achieve desired objectives. While the CVW commander maintains operational control of all organic air assets, sorties are normally made available to the JFC for tasking through the JFACC in support of JAAT operations.

SECTION III – EXECUTION

BASIC JOINT AIR ATTACK TEAM COMPONENTS

C-45. The JAAT mission commander must effectively integrate the following five components to accomplish the assigned mission:

- ACMs.
- Check-in and briefing.
- Firepower timing options.
- Attack methods.
- Disengagement.

AIRSPACE COORDINATION

C-46. The following four methods are used to establish an ACA to deconflict attack helicopter and FW aircraft from indirect fires:

- Lateral/geographic separation (figure C-1, page C-9).
- Altitude separation (figure C-2, page C-9).
- Time separation (figure C-3, page C-10).
- Combination of the above.

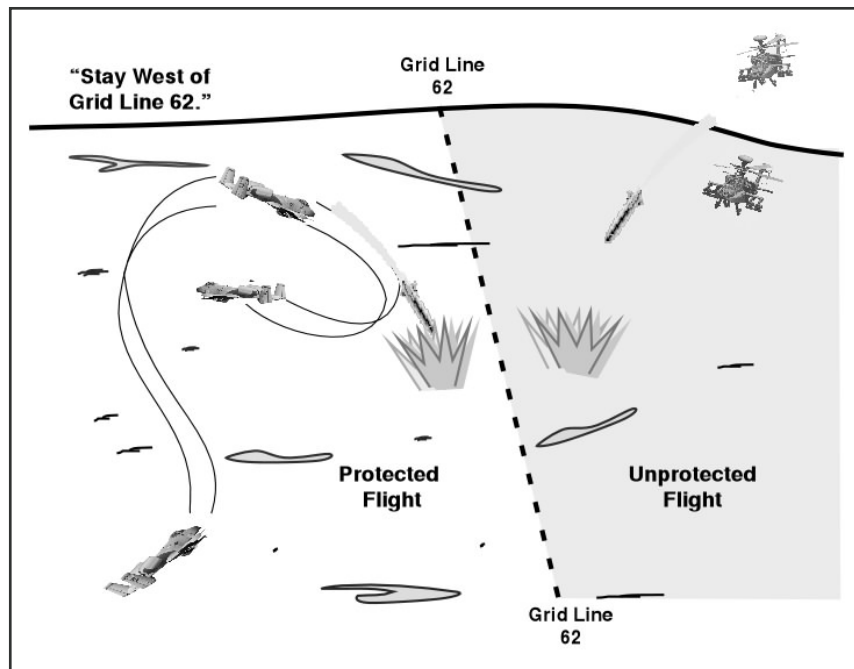

Figure C-1. Lateral/geographic separation

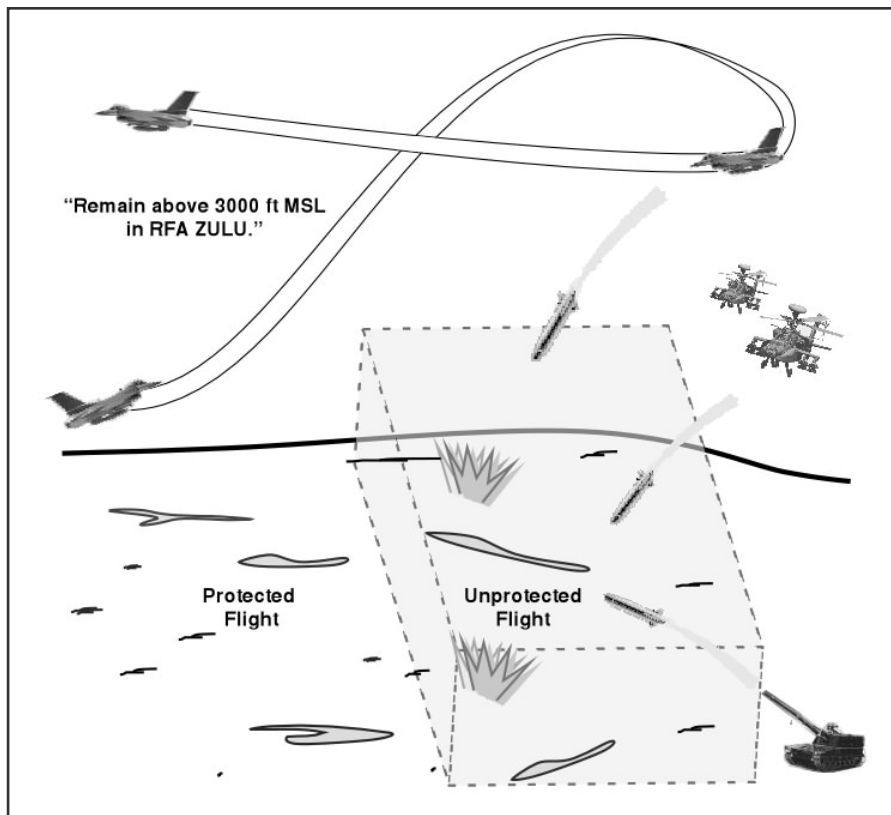

Figure C-2. Altitude separation

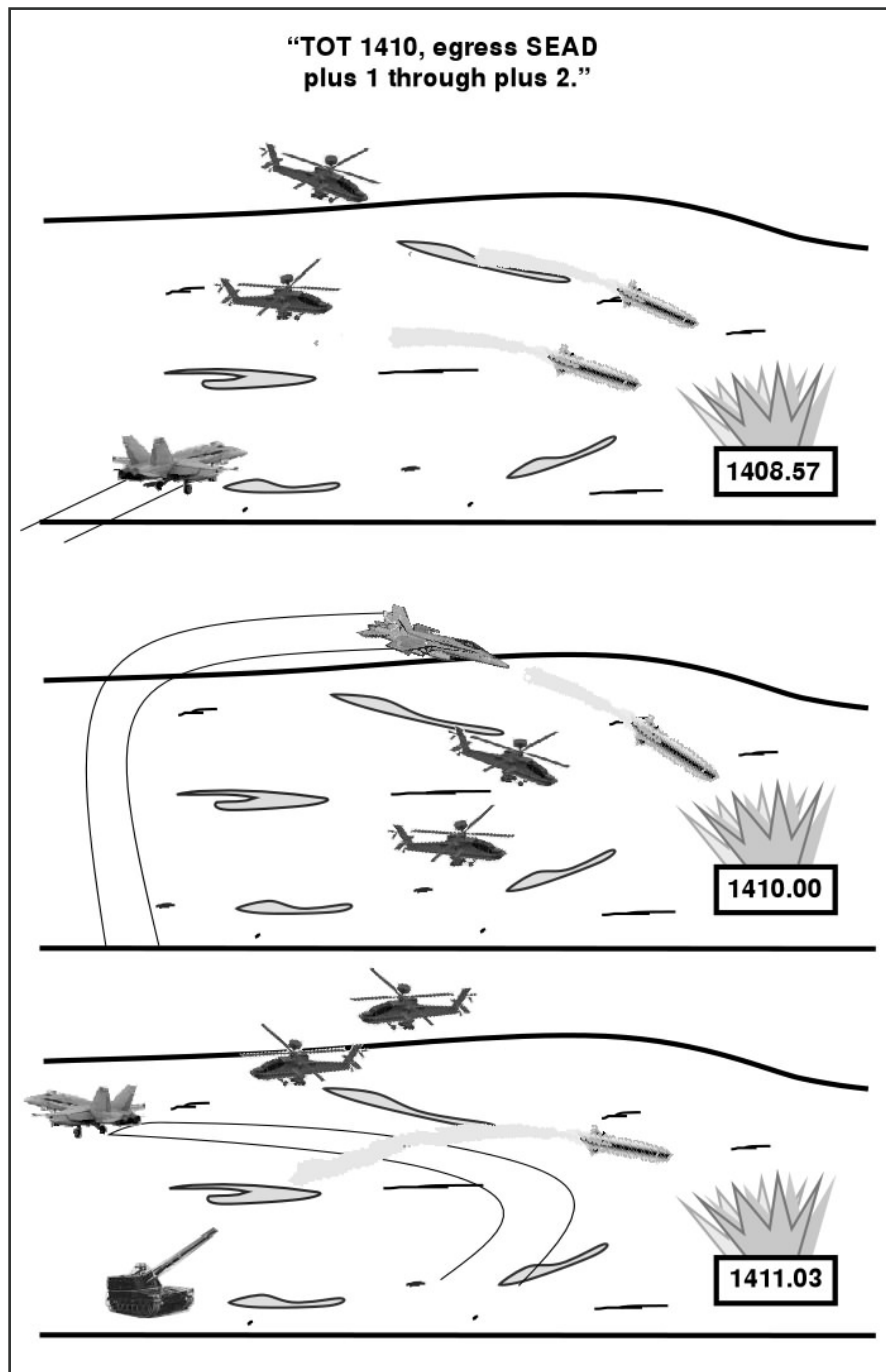

Figure C-3. Time separation

C-47. The fire plan includes appropriate airspace coordination measures and coordinates use of ACAs for JAAT operations. For more information on ACAs, see JP 3-52 and FM 3-09.32.

C-48. The mission commander is responsible for ensuring ACMs are established and coordinated with all JAAT participants. Airspace management methods in the objective include ACAs, restrictive fire headings, maximum ordnance trajectory, minimum altitude, sectors, and timing separation.

Appendix C

C-49. Detailed ACMs, disseminated via DD Form 1972, can be used during preplanned JAAT operations, while immediate missions may require simpler coordinating measures. All participants must understand established coordinating measures.

CHECK-IN AND BRIEFING

C-50. FW participants check-in with the TACP, FAC (A), or Army AMC in accordance with CAS check-in briefing (figure C-4).

CAS CHECK-IN BRIEFING Aircraft Transmits to Controller	
Aircraft " _____ this is _____ "	
(Controller Call Sign)	(Aircraft Call Sign)
Note: Authentication and appropriate response suggested here. The brief may be abbreviated for brevity or security ("as fragged" or "with exception").	
Identification/Mission Number: _____	
Number and Type of Aircraft: _____	
Position and Altitude: _____	
Ordnance: _____	
Play Time: _____ (if applicable)	
Abort Code _____ (NVG, LST, Special Mission Items)	
*Remarks (as appropriate): _____	
*Optional Entry	

Figure C-4. CAS check-in briefing

C-51. After initial contact between the flight lead and controller has been established, the controller provides the standard 9-line CAS brief to the FW flight lead (figure C-5, page C-12).

CAS BRIEFING FORMAT (9-LINE)	
<i>(Omit data note required, do not transmit line numbers. Unit of measure are standard unless otherwise specified. *Denotes minimum essential in limited communications environment. BOLD denotes readback items when requested.)</i>	
Terminal controller:“ _____ this is _____ ”	
(Aircraft Call Sign)	(Terminal Controller)
*1. IP/BP:“ _____ ”	
*2. Heading :“ _____ ” (Magnetic)	
(IP/BP to Target)	
Offset “ _____ (Left/Right)	
*3. Distance: _____ ”	
(IP-to-Target in Nautical Miles/BP-to-Target in Meters)	
*4. Target Elevation: _____ ”	
(in Feet/MSL)	
*5. Target Description: _____ ”	
*6. Target Location:“ _____ ” (Latitude/Longitude or Grid Coordinates or Offsets or Visual)	
*7. Type Mark:“ _____ ” Code: “ _____ ”	
(WP, Laser, IR Beacon)	(Actual Code)
Laser to Target Line:“ _____ Degrees”	
*8. Location of Friendlies: _____ ”	
Position Marked By: _____ ”	
9. Egress: _____ ”	
Remarks (as appropriate): _____ ”	
(Threats, Restrictions, Danger Close, Attack Clearance, SEAD, Abort Codes, Hazards)	
*TOT:“ __ “ or TTT: “Stand by __ plus ____, Hack.”	
Note: When identifying position coordinates for joint operations, include the map datum data.	

Figure C-5. CAS briefing format

FIREPOWER TIMING OPTIONS

C-52. The three firepower timing options (table C-2)—simultaneous, sequential, and random—are used to mass and deconflict fires. These timing options are employed using the attack methods described later in the section.

Table C-2. Comparison of firepower timing options

	Advantages	Disadvantages
Simultaneous	<ul style="list-style-type: none"> Masses fires. Maximizes shock effect. Complicates enemy ADA targeting scheme. Unpredictability. 	<ul style="list-style-type: none"> Complicates target array sorting & direct fire planning. Simultaneous weapons impacts can interfere with one another.
Sequential	<ul style="list-style-type: none"> Target area marked for subsequent attackers. Continuous pressure on target over time allows attackers to reposition while other attackers shoot. Less interference from weapons effects for subsequent shooters. Ensures individual targets are not double-targeted. Preference for multiple flights of FW. 	<ul style="list-style-type: none"> Enemy ADs can target all players. Takes longer, reduces shock effect, & could provide opportunities to the enemy.
Random	<ul style="list-style-type: none"> Easiest on pilots—no timing required. Reduced C2 requirements. Unpredictability. 	<ul style="list-style-type: none"> Requires aircraft/weapons deconfliction. No guarantees for effects, possible loss of pressure on the enemy. May complicate FS plan.

ATTACK METHODS

C-53. The attack methods describe control techniques for attacking targets within an objective area and is briefed during the 9-Line. Methods may apply to the joint attack as a whole and again within each attacking flight or units’ individual attack plan. The two attack methods are combined and sectored.

Combined Method

C-54. The avenue to the target is shared airspace. During this attack, all JAAT members fly in the same area. The AMC references the FW’s 60-second call, visually acquires the FW, and directs the attack helicopters to engage. The intent, in this case, is for all elements to attack simultaneously. FW flight is directed to attack the northern half of the specified target area. After attacking, the FW are directed to clear the target area. This may imply a follow-on artillery barrage or simply reflect the ground commander’s scheme of maneuver (figure C-6, page C-14).

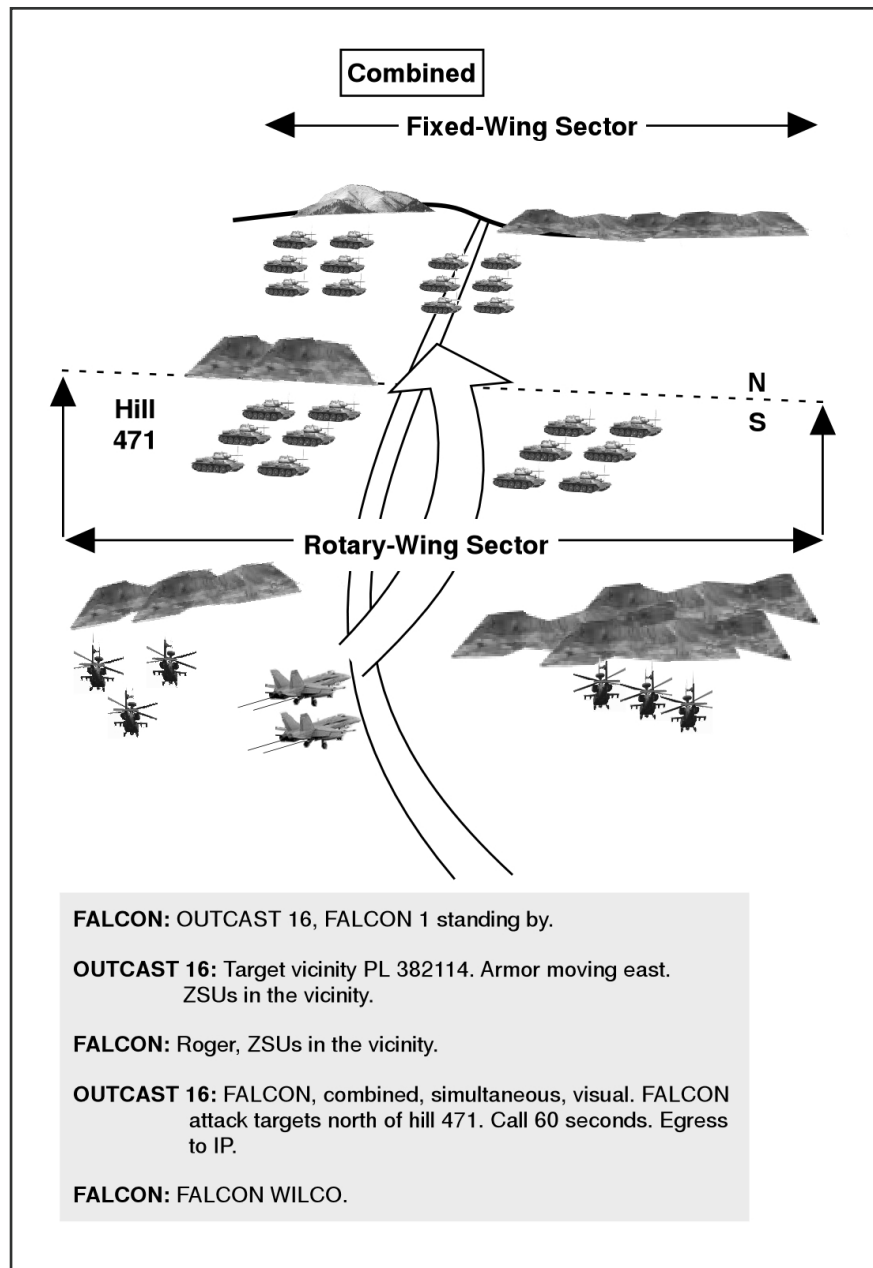

Figure C-6. Example of combined attack

Sectored Method

C-55. The avenue to the target is sectored (using acknowledged sectors). During this attack, the A-10 flight maneuvers exclusively west of a north/south line drawn through the target area (the road). The mission commander directs the A-10 flight to attack at a specified time on target (TOT). The timing coordination call (60 seconds in this example) is requested to update the attack plan timing. Pilots must still deconflict weapons fans to preclude friendly casualties. While ensuring weapons or weapons effects do not cross an established sector line, a rule of thumb commonly employed is to never fire more than 30-degrees towards or into the other sector. Coordination between the type of attack and timing option is vital (figure C-7, page C-15).

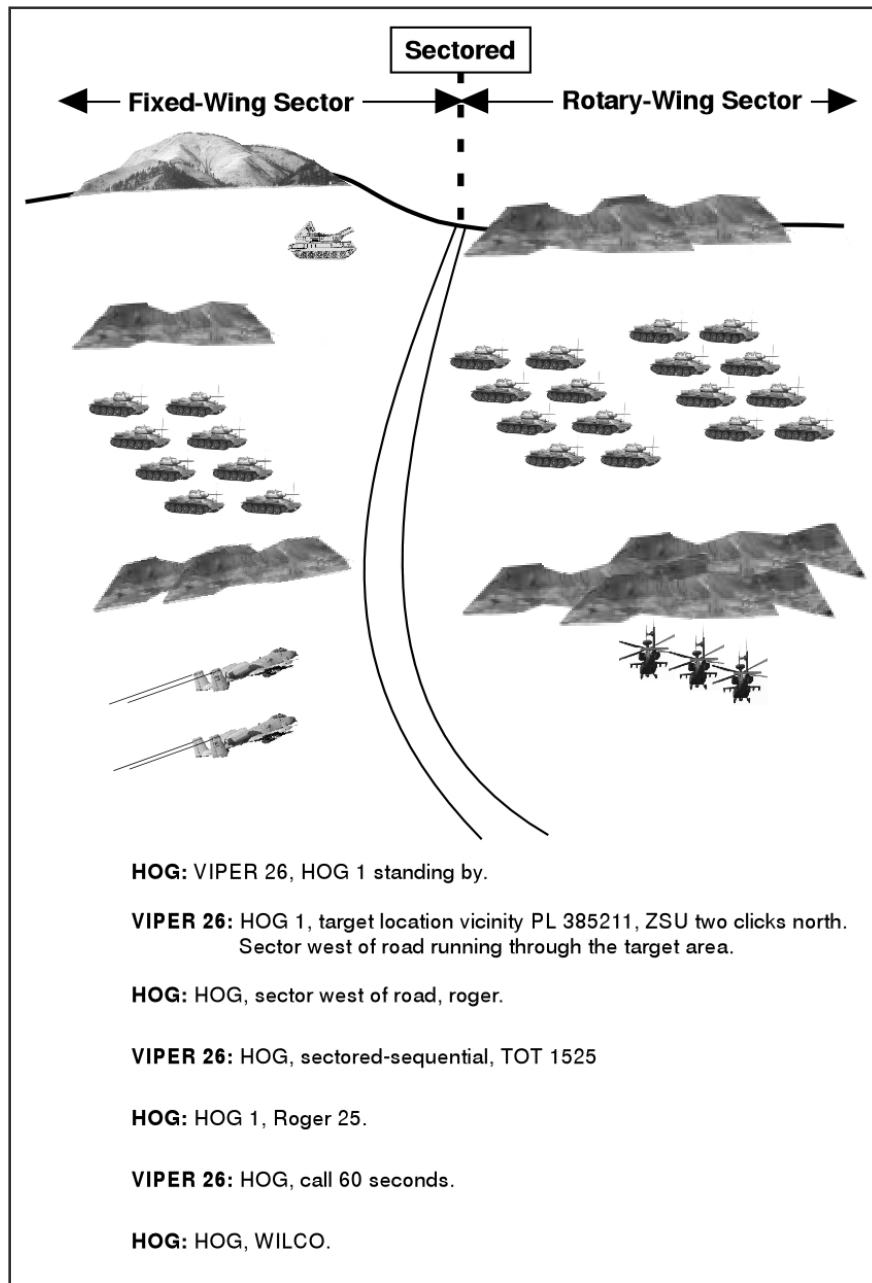

Figure C-7. Example of a sectored attack

DISENGAGEMENT

C-56. Consideration must be given to the disengagement phase of the operation. These considerations include covering fires and route of egress.

Covering Fires

C-57. Fixed- and rotary-wing aircraft may provide suppressive fires and SEAD as other elements egress. Artillery (cannon, Multiple Launch Rocket System [MLRS], and Army Tactical Missile System

[ATACMS], if authorized) can also provide suppressive and SEAD fires. EW assets also may provide SEAD with anti-radiation missiles or electronic attack.

Route of Egress

C-58. Due to the flexible nature of operations, planned egress routes may not be available to all JAAT participants. Consideration must be given to coordinating new egress routes.

Example: FW aircraft might be tasked to provide reconnaissance of a hasty rotary-wing egress route.

RISK MANAGEMENT

C-59. Risk management consists of identifying hazards and implementing controls during planning, preparation, and execution. During the execution phase, all participants in the JAAT focus primarily on implementation of controls. However, as additional hazards are identified during execution, participants must implement additional controls.

C-60. Hazards to consider include—

- Enemy forces/threats.
- Weapons release parameters/dangers.
- Surface danger zones.
- Laser operations.
- Environmental factors.
- Friendly unit location/SU.
- Human factors.
- Battlefield obscuration/clutter.
- Terminology.

C-61. Control measures used to mitigate risk may include—

- ACMs.
- Flight techniques tactics.
- Use of personnel specifically trained and experienced in JAAT operations.
- Lethal and nonlethal SEAD.
- FSCM.
- Suppressive fires.
- Positive control.
- Reasonable assurance/indirect control.

C-62. Minimum criteria include—

- Adequate SA.
- Known location of friendly elements.
- Positive hostile identification.
- Minimum separation for munitions employment (fragmentation deconfliction).
- Communications.
- Friendly combat identification (IFF, IR markings, lights).
- Authentication.

NIGHT CONSIDERATIONS

C-63. Tactics procedures for night employment of the JAAT remain the same as for day operations. However, techniques required to accomplish night JAAT operations tactics involve a more deliberate tempo and strict adherence to these basic procedures to ensure all participants maintain SA. FM 3-09.32 and unit/aircraft specific tactics manuals provide detailed information on conducting night operations.

C-64. Perspective and target resolution vary based on aircraft systems. The aviation mission commander must provide a detailed description of the objective area to ensure all participants, regardless of perspective or available sensors, have a clear picture of the objective area. Night sensor/NVG used by all participants greatly increase capability and effectiveness of the JAAT; however, certain limitations exist. A terrain feature visible by a NVG/ FLIR equipped rotary-wing aircraft at 50 feet may not be visible or recognizable by an NVG-equipped pilot or for a FLIR equipped aircraft at 20,000 feet.

C-65. Night positive control is more difficult as controllers cannot observe both target and attacking aircraft. Friendly and threat SA is necessary. Aircraft lighting, thermal combat identification, ground unit identification, and location descriptions all aid in SA.

C-66. IR illumination, offset illumination, IR pointers and illuminators, indirect fires, direct fires, laser, and grid coordinates are all techniques for marking targets. Consideration must be made for the marker effects on all participants.

CONTROL MEASURES

C-67. Figure C-8, page C-18, depicts example measures assisting JAAT participants in controlling their fires. Other factors include—

- Attack heading.
- Weapons selection for pass.
- Ingress and release altitudes.
- Dive angle.
- Distance from target.

LASER BACKGROUND

C-68. Modern rotary-wing laser systems greatly enhance effectiveness of the JAAT by offering increased mobility, accuracy, and lethality. Airborne target lasing capabilities coupled with laser spot tracking equipment provide greater efficiency, integration, and distribution of weapons effects. Due to the variety of laser systems employed during a JAAT operation, laser techniques and procedures, along with specific laser codes, must be coordinated by all JAAT elements to ensure successful operations. Laser code and laser-to target line information is found on line 7 of the 9-line brief. JAAT procedures have been developed and successfully tested using Apache laser designators with the laser spot tracking equipment on aerial vehicle-8 Harriers, F/A-18 Hornets, and A-10 Thunderbolt II. The scenario and descriptions of JAAT operations using laser operations cite the A/AO-10 for illustrative purposes only.

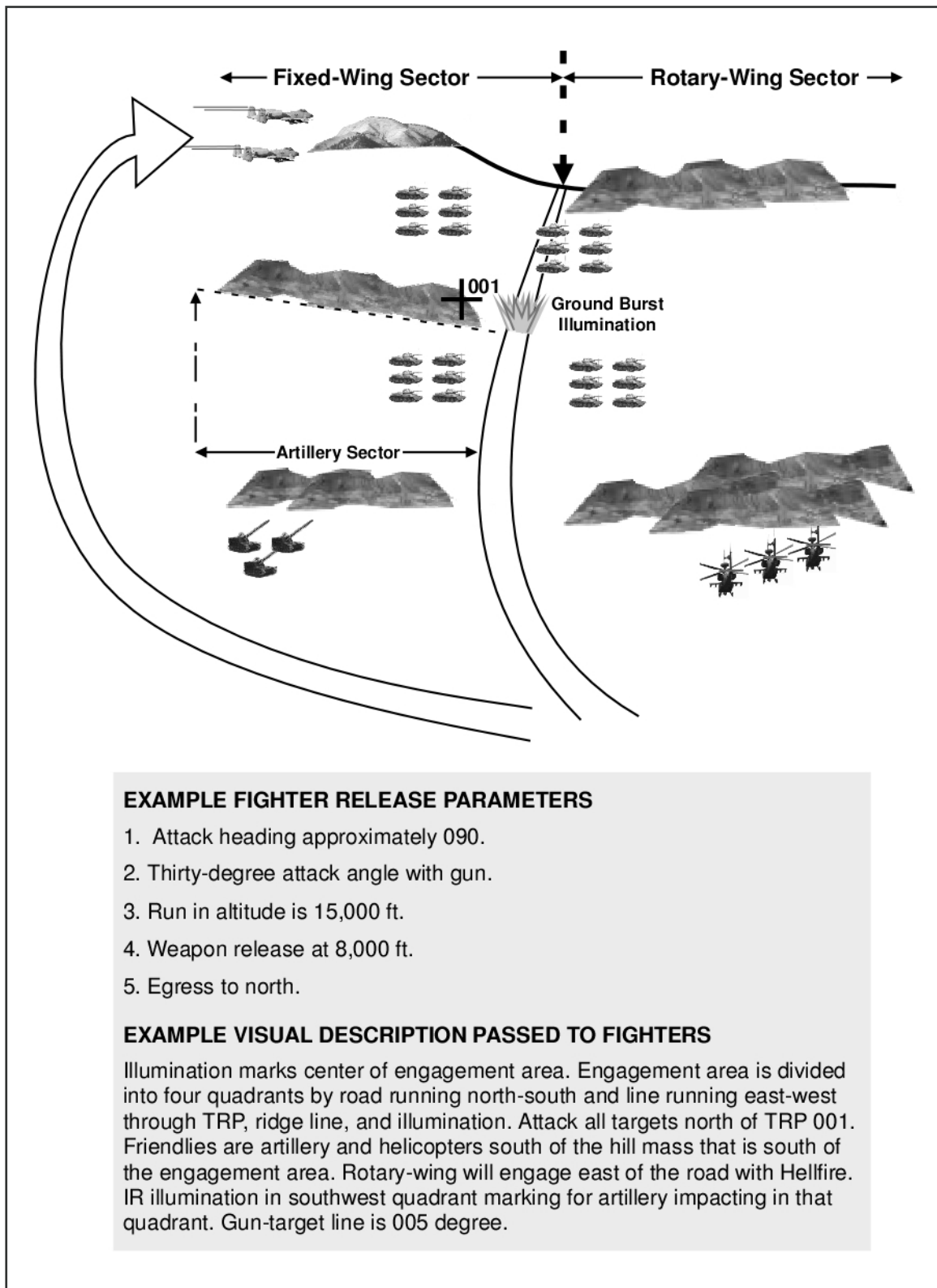

Figure C-8. Night JAAT and associated control measures

OPERATIONS

C-69. JAAT-laser calls are made on the JAAT common frequency. Airborne LSTs for target acquisition accept four digit codes; ground systems accept only three digit laser codes. Therefore, aircrews must place a 1 at the first digit of the laser code.

C-70. The terminal controller ensures the following events occur for an effective JAAT:

- Include laser code and laser target line (LTL) on line 7 of the 9-line brief.
- Aircraft avoid the 20-degree safety zone (10 degrees either side of the LTL for aircraft run-ins).
- Brief pilot, if possible.
- Plan early and prepare FO teams/ fire support teams ready for mission.
- Ensure code in laser target designator matches code pilot passed.
- Actual LTL is no more than 5 degrees off briefed LTL.
- Explain he in control and the laser target designator is operated at his command.
- Ensure simple and easily understandable communications are in place.
- Ensure appropriate safety zone is established around laser designators and friendly units are not overflowed during weapons employment.

RADIO CALLS

C-71. The required radio calls for laser operations are found in table C-3 and FM 90-21.

Table C-3. Laser operations example radio calls

A-10: "HOG 1, departing IP"
AH-64: "Apache 1, roger"
A-10: "Hog 1, 60 seconds Maverick"
A-10: "Hog 1, 10 seconds"
A-10: "Hog 1, laser on"
AH-64: "Apache 1, laser on"
A-10 "Hog 1, spot"
A-10 "Hog 1, rifle"
A-10 "Hog 2, shift, gun"
AH-64: "Apache 1, shift.....set"
A-10: "HOG 2, spot"
A-10: "HOG 2, terminate"

Departing Initial Point

C-72. This is a situation awareness call informing all in the JAAT the CAS/FW flight has departed the initial point and is inbound to the target.

Timing Coordination and Type Weapon Call

C-73. The timing coordination call notifies the mission commander the FW flight is inbound and states approximate amount of time from attacking in the immediate target area. It also alerts the Army asset as to what type of weapons (for example, missiles, and guns) will be used. Normally, 60 seconds gives the laser designator time to complete the present engagement, acquire a new target, and prepare to laser it.

Directive to Standby

C-74. **Ten seconds.** The directive to terminal controller is given to standby for laser on call in approximately 10 seconds. The laser should be turned on in 10 seconds even if the laser on call is not heard.

Directive to Start Laser Designation

C-75. **Laser on.** The laser is turned on. Normal laser designation time is 20 seconds maximum. The aircrew may request a longer laser on time by saying laser on and time (laser on, 30 seconds.).

Acquisition of Laser Designation

C-76. The aircrew calls SPOT when acquiring the laser spot, confirming to the FAC and wingman the aircraft or weapon laser seeker has identified a source of laser energy which may be the designated target. For multiple aircraft in the same attack, SHIFT calls may be used after the lead aircraft calls SPOT to direct the laser designator operator (LDO) to shift the laser to the next aircraft's target. This call is usually used for target acquisition in conjunction with weapons not requiring terminal laser guidance.

Maverick Launch

C-77. **Rifle** (AGM-65 Maverick launch). The advisory call indicates the Maverick missile is inbound.

Directive to Shift Laser Illumination

C-78. **Shift.** Once the lead aircraft engages the target, a shift call can be made to shift the laser to the next target. The laser must remain on during the shift to maintain a laser lock-on. If the laser is turned off, the laser spot tracking equipment reverts to a search mode. Depending on the search mode, it could take 10 to 20 seconds to reacquire the laser energy, leading to unacceptable exposure times and aborted attacks.

Terminate

C-79. **Laser illumination of a target ceases.** This call indicates the laser is no longer needed. Careful planning must be done when FW are attacking in line or wedge formations to ensure that the lead aircraft does not terminate the laser before the wingman's lock-on. When in trail, each aircraft may want to make separate laser on and termination calls, depending on their separation. Minimizing the time a laser is on is important in a laser countermeasure environment and when employing battery operated laser designators.

C-80. The laser operator turns the laser off—

- When terminate call is heard.
- When the weapon hits the target.
- After 20 seconds (or longer if requested).

Appendix D

Briefings, Reports, and Formats

This appendix provides a reference for briefings, reports, and formats used by aviation units during training or combat to more efficiently accomplish assigned tasks and missions. Please note, it is not all inclusive; products are used as a guide and do not supersede unit SOPs.

PREDEPLOYMENT AND PRETEMPORARY DUTY

D-1. Table D-1 provides example for predeployment and pretemporary duty requirements.

Table D-1. Example for predeployment and pretemporary duty

Finance			
Yes	No	N/A	Task/Action
			Bills, recurring and nonrecurring.
			Bank accounts, checking, savings, loans. Investments and other income sources.
			Safety deposit boxes.
Legal			
			Power of Attorney as needed (specific, general).
			Wills updated.
			Living wills updated.
			Spouse's SSN.
			Guardianship for children.
			Insurance policies; life, auto, home/renters, floater.
			Deeds, leases, rentals, real estate documents, management company.
			Marriage or divorce papers.
			Birth certificates, adoption papers.
			School records.
			Naturalization documents.
			Vehicle titles and registration.
			Taxes.
			Necessary court documents.
Personnel Issues			
			TDY or PCS orders.
			Emergency data cards complete.
			ID cards, copy, expiration dates, DEERS enrollment.
			SGLI.
			Passport and Visa documents.
			Family care plan.
			NEO/Safe haven information.
			Personal affairs; funeral and burial instructions.
Household			
			Vehicle registration, inspection, all stickers and tags.
			Crime prevention measures/force protection information.
			Maintenance/utilities/list of who to contact for problems and repairs.
			Disaster/evacuation plan and survival kit; water, food, clothing, other personal necessities.

Table D-1. Example for predeployment and pretemporary duty

Communication		
Community contact information		
		Local emergency contacts; police, fire, Red Cross, poison control, hospital, TRICARE.
		Post Chaplain, ACS, MPs.
		Web sites; www.afcrossroads.com, www.militaryonesource.com.
Unit contact information (include phone numbers, physical address and e-mail address)		
		Unit name, DIV, BDE, BN, CO.
		Commander, CSM/1SG, UMT, supervisor.
		Family Readiness Group spouses.
		Orderly room, SDO, FOD.
		Rear detachment commander/OIC and NCOIC.
		TDY; dates, location, phone and emergency phone.
Personal contact information		
		Family.
		Friends.
		Immediate neighbors.
		Financial.
		Insurances.
		Emergency family and friends.
Medical		
		TRICARE enrollment/claim process.
		Locations/providers/clinic contact information.
		Records; medical, dental, shot, other.
Pets		
		Records.
		Veterinarian; regular and emergency.

CONVOY PRECOMBAT INSPECTION

D-2. Table D-2 provides an example for convoy precombat inspection requirements.

Table D-2. Example for convoy precombat inspection

	Completed
Vehicles:	
Vehicles are inspected at operating temperatures with hoods open.	
5988Es are current with all parts installed.	
Vehicle fuel will be topped off.	
All basic issue items present and serviceable.	
Three days rations per Soldier per vehicle.	
Five-gallon water cans topped off.	
Water buffalo sanitized and topped off.	
All supply trucks are covered.	
Complete combat lifesaver bag on hand (if applicable.)	
Weapons:	
Crew-served weapons functionally checked.	
.50-cal headspace and timing set.	
Functions check on all individual weapons.	
5988Es are present and current for all crew-served weapons .	

Table D-2. Example for convoy precombat inspection

All weapons are lubricated.	
Communications:	
Radios loaded with correct frequencies. Call signs recorded.	
5998Es are all current with PMCS and manual.	
Batteries are present for dismounted radios.	
Long-range radio checks are complete.	
Digital nonsecure voice telephones are present with 2 miles of WF-16 wire per phone.	
TA-1s or TA-312s are operational with 1 roll of WD-1 per set.	
Automated net control devices are present and loaded.	
CBRN Equipment:	
5988Es are present for all CBRN equipment.	
M-8/M-22 alarms are complete with batteries and operational alarm.	
IM-93 is present and operational.	
M8 and M9 paper present and attached.	
M256A1 chemical detection kit (1 per squad) on hand.	
CBRN markers are present and stocked.	
CBRN teams identified.	
Night Observation Devices (NODs):	
5988Es are present and complete for all NODs.	
15-day supply of batteries for all NODs.	
Carrying cases are complete with accessories and lens cleaning equipment.	
Individual Soldier:	
Load-bearing equipment worn in accordance with TACSOP and properly fitted.	
Flack jacket is present/Gortex jacket if necessary.	
Flashlight present with the appropriate filter.	
Identification tags and identification card present.	
7 magazine per M-16/M-4; 3 per M-9 9-mm.	
Department of the Army Form 1156 in the first aid pouch and left pocket of the chemical protective overgarments.	
Serviceable first aid packets.	
One-quart canteen with cup and cover (extra canteen optional) present. Canteens must be filled and fitted with CBRN cap.	
All Soldiers understand the mission.	
Drivers:	
5988E with current PMCS and quality control within 72 hours.	
Dispatch signed by the driver and the company commander/XO.	
Driver has a current ULLS computer-generated license.	
Driver has combat service support graphics, control measures, and a map of the operational area.	
Leaders:	
Map with current graphics and/or strip map.	
Field trains TACSOP.	
Leaders have appropriate FMs and Army training and evaluation program (ARTEP)-MTPs.	
List of all sensitive items on company standardized sensitive items sheet.	
Current list of all vehicles organic or attached.	
Current signal operating instructions for brigade support area and TF.	
S-2 threat assessment.	
Prepared convoy commander brief.	

PRECOMBAT

D-3. Table D-3 provides example for precombat operations requirements.

Table D-3. Example for precombat inspections

Platoon Sergeant	Check	Platoon Sergeant (cont'd)	Check
Personnel Accounted For		Platoon Status to First Sergeant	
Individual PCI Completed		Situation Briefed	
Reference Publications Reviewed		MREs Issued	
Uploaded by Load Plan		Personnel Accounted For	
Expendable Supplies on hand		Individual PCI Completed	
Communications Equipment		Reference Publications Reviewed	
Equipment Accounted For		Uploaded by Load Plan	
Radios		Expendable Supplies on hand	
Microphones		Sleep Plan Established	
Operation Equipment		MOPP Level known and disseminated	
Maps, Updated		Weapons control	
Compasses		Section Status to Platoon Sergeant	
Pens, etc		Situation Briefed	
Sleep Plan Established		MRE's Issued	
Class V Issued		Ammo Basic Load Issued	
MOPP Level known and disseminated		Personnel Accounted For	
Weapons control		Individual PCI Completed	

COMBAT OPERATIONS

D-4. Table D-4 provides an example for PR planning requirements.

Table D-4. Example for personnel recovery planning

Personnel Recovery Planning Requirements	
Date Time Group (DTG) Notified:	
Prepermission planning	Go/No-Go
Record event on appropriate incident form	
Determine PR plan of action	
Complete PR worksheet	
Obtain current INTEL brief	
Obtain ISOPREP, authentication data, and EPA	
Determine threat level	
Obtain weather brief	
Study terrain/obtain sea conditions	
Determine survival equipment	
Determine CBRN contamination	
Determine medical status	
Special considerations	
Complete PR planning:	
PR plan (forces, timing, locations)	
Comm plan/flight following including backups	
Rescue forces informed	
Support forces requested (as requested)	
OSC appointed /notified	
Coordination complete with all PR forces	
Mission Execution	
Monitor mission progress	
Start times	
Keep component rescue coordination center (RCC)/ISRC advised of actions	

Table D-4. Example for personnel recovery planning

Personnel Recovery Planning Requirements	
Date Time Group (DTG) Notified:	
Prepermission planning	Go/No-Go
Arrival times at scene	
Arrange for transport of injured (as required)	
Obtain additional PR forces/support (as required)	
Complete reports (as required)	
Closing Actions	
Rescue personnel debriefed	
INTEL debriefed (as required)	
Component RCC/ISRC notified of mission results	
Rescued personnel status confirmed	
Paperwork complete	
PR Precombat Checks/Precombat Inspection	
Medics kit inventoried, splints, IV bags, sufficient for full up crew of downed aircraft (UH-60=four personnel, AH-64 and OH-58=two personnel).	
Commo cards accurate? (prepared by RCC)	
Location of Level I & II Care known, frequencies and approach paths into C Med. known?	
Contingency plans for early departure from battle, return crossing of PP if cross-FLOT?	
Aircrew knowledge of adjacent airspace coordination measures.	
Personnel qualified/trained/rehearsed.	
Weapons PCC/PCI.	
Battle graphics on maps.	
Safing procedures for downed aircraft.	
Personnel should be trained on the use of all survival equipment to include the forest penetrator and horse collar.	
Emphasis should be placed on letting the hoist cable ground itself before touching.	
Personnel Recovery Planning Requirements	
Date Time Group (DTG) Notified:	
Prepermission planning	Go/No-Go
Ensure that they have completed DD Form 1833 (Isolated Personnel Report (ISOPREP)).	
Ensure PRC-112 radios are programmed correctly with frequencies and isolated personnel code.	
Airspace Coordination Measures	
Must have coordination for PPs in cross-FLOT.	
Must have location of Level II care, communication, and familiar with landing site at Level II care.	
Must have knowledge of all airspace available and ability to coordinate passage through adjacent airspace.	
Enemy Situation.	
Friendly Situation.	
Air Routes.	
Individual PR related requirement.	
All aircrew personnel should wear on their person the following equipment: <ul style="list-style-type: none"> • A survival vest with CSEL or PRC-112 radio. • Strobe light with IR cover. • 6 chemlights. • Signal mirror. 	
Ensure that they have completed DD Form 1833.	
Ensure PRC-112 radios are programmed correctly with frequencies and isolated personnel code.	
Security team personnel should be equipped with the following nonstandard items: <ul style="list-style-type: none"> • Crash rescue (quickie) saw. • Crowbars. 	

Table D-4. Example for personnel recovery planning

Personnel Recovery Planning Requirements	
Date Time Group (DTG) Notified:	
Premission planning	Go/No-Go
<ul style="list-style-type: none"> • Crash axes. • Rappel ropes. • STABO harnesses. • Aviator flak vests. • SABRE radios (w/headsets). • PRC-112s. • Additional back boards and medical supplies. 	
AMC	Go/No-Go
Appoint an OSC. <ul style="list-style-type: none"> • Usually wingman (will have location and condition information). • If not wingman relay vicinity and condition if known. • Consider station time and weapons load. 	
Ensure OSC authenticates the downed aircrew ASAP IAW the spins and passes all used/compromised authentication data to higher.	
Obtain PRC-112 CSEL codes (PLS codes) and ISOPREP data from S-2 and pass to RMC or OSC.	
Coordinate and monitor PR radio nets.	
Manage flow of aircraft to and from the objective area.	
OSC	
Authenticate isolated personnel. <ul style="list-style-type: none"> • Record all used: • Call sign _____ • Authentication used _____ 	
Personnel Recovery Planning Requirements	
Date Time Group (DTG) Notified:	
Premission planning	Go/No-Go
Evaluate: Why did aircraft go down? _____ Check all assets for: <ul style="list-style-type: none"> • Station time _____ • Ordnance _____ • What is needed/on the way? _____ • Reset Bingo (don't overfly) _____ • Weather options _____ 	
RMC	Go/No-Go
Complete all necessary information in the Rescue Mission Brief.	
Determine Isolated Personnel's available signaling devices.	
Conduct a thorough threat assessment: <ul style="list-style-type: none"> • Recommend ingress and egress routes • Inform RESCORT of threat positions so they can be circumvented. • Request additional support if required. 	
Make Go/No-Go recommendation based on information gathered at the objective area.	
Brief replacement RMC/RESCORT using the Rescue Mission Brief	

Table D-4. Example for personnel recovery planning

Personnel Recovery Planning Requirements	
Date Time Group (DTG) Notified:	
Permission planning	Go/No-Go
Prepare the Isolated Personnel for pick-up	
Reauthenticate the Isolated Personnel after OSC changeover only when the situation warrants	

SARIR TEMPLATE		INFO: ALPHA	DTG
LINE 1	CALL SIGN		
LINE 2	AIRCRAFT TYPE		
LINE 3	NATIONALITY		
LINE 4	BAILOUT LOCATION		
LINE 5	SOURCE TIME ALTITUDE WINDS		
LINE 6	GROUND LOCATION		
LINE 7	SOURCE TIME		
LINE 8	DTG OF INCIDENT		
LINE 9	CAUSE OF INCIDENT		
LINE 10	DETAILS		
LINE 11	CONDITIONS OF ISOLATED PERSON		
LINE 12	LAST CONTACT		
LINE 13	REPORTED BY METHOD AUTHENTICATED YES OR NO		
LINE 14	AUTHENTICATION USED		
LINE 15	SITUATION AIR DEFENSE GROUND		
LINE 16	SAR CODE/PLS 112 CSEL CODE		

CORDON AND SEARCH

D-5. Table D-5 is an example for cordon and search requirements.

Table D-5. Example for cordon and search

CORDON AND SEARCH REQUIREMENTS					DTG Msn Conducted:		
Msn Name:	Mission Statement:						
Unit:	C/S:	Freq: P/A		Msn Time:			
No#/Type Veh:				Type Marking:			
Timeline							
Event	Time	Waypoint	Location	Rmk	Waypoint	Location	Rmk
Convoy Start Point							
Convoy RP							
Cordon Set							
A/C On Station							
Msn Complete							

Appendix D

FS							Building Marking		
C/S	Freq	Location	Type	Name	Location	How Marked			
Msn Info									
Type Msn				Convoy Security					
Recon		Before	During	After	Infil	Yes/No			
Obj And Orientation					Exfil	Yes/No			
Standoff/Overwatch		Before	During	After	Msn Remarks:				
Rmk									
Presence		Before	During	After					
Obj And Orientation									
Add. Areas Of Interest									
Rmks									

RESCUE MISSION BRIEF

D-6. Table D-6 provides an example rescue mission brief.

Table D-6. Example rescue mission brief

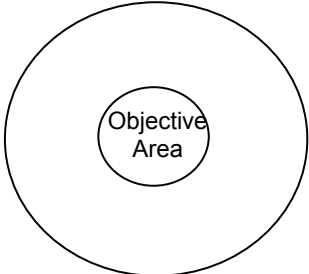
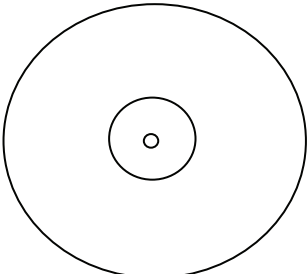
Rescue Mission Brief			
Survivor Information			
Call sign			
Number of survivors			
Location - Circle appropriate GRID - L/L RNG/BRG - SARDOT/DPP GPS, map or flyover			
Condition/Injuries		Walking (yes or no)	
Equipment (Communication/Signal)			
Authentication Complete (yes/no)		Method	
Recovery Area Brief			
Threats			
Elevation			
Description			
RESCORT Plan			
IP			
Ingress			
Egress			
Ordinance			
RESCORT Tactics			
Interior			Exterior
			

LANDING ZONE SURVEY

D-7. Table D-7 depicts an example for LZ survey requirements.

Table D-7. Example landing zone survey

SURVEY DATE:		LZ#:		LZ NAME:	
GPS COORD:			MGRS GRID:		
LANDING AREA					
TYPE:	<input type="checkbox"/> Helipad	<input type="checkbox"/> Field	<input type="checkbox"/> Road	<input type="checkbox"/> Other _____	
SURFACE:	<input type="checkbox"/> Level	<input type="checkbox"/> Sloped	<input type="checkbox"/> Rocky	<input type="checkbox"/> Dusty	<input type="checkbox"/> Wet
WIND INDICATOR:	<input type="checkbox"/> Wind Sock	<input type="checkbox"/> None	<input type="checkbox"/> Other _____		
LIGHTING:	<input type="checkbox"/> Chem-lite	<input type="checkbox"/> Bean Bag	<input type="checkbox"/> Inverted Y	<input type="checkbox"/> None	<input type="checkbox"/> Other _____
LZ OBSTACLES					
	<input type="checkbox"/> Towers	<input type="checkbox"/> High Grass	<input type="checkbox"/> Brush	<input type="checkbox"/> Trees	<input type="checkbox"/> Buildings
	<input type="checkbox"/> Poles	<input type="checkbox"/> Wires/Height	<input type="checkbox"/> Other _____		
APPROACH INFORMATION					
LZ Long Axis: _____ (degrees magnetic)			LZ Size: (meters) _____ x _____		
Approach Heading: _____			Departure Heading: _____		
NUMBER/TYPE AIRCRAFT:					
UH-60	CH-47	OH-58	AH-64		
FLIGHT ROUTE					
Sample					
UNAIDED NIGHT OPS:			NVD OPS:		
<input type="checkbox"/> Yes <input type="checkbox"/> No			<input type="checkbox"/> Yes <input type="checkbox"/> No		
ACCESSIBILITY					
<input type="checkbox"/> Ground/Emergency Vehicles			<input type="checkbox"/> Other _____		
CONSIDERATIONS:					
<input type="checkbox"/> Near Housing Area		<input type="checkbox"/> Noise Abatement		<input type="checkbox"/> Other _____	
RESTRICTIONS/REMARKS: (OGE, IGE, Number & Type A/C, Day Only, etc.)					
LZ SKETCH/PHOTO: (Attach to this document)					
DISTRIBUTION:					
<input type="checkbox"/> Reading File			<input type="checkbox"/> Detachment Ops Files		
SURVEYOR: _____					
RISK:					
<input type="checkbox"/> Low		<input type="checkbox"/> Medium		<input type="checkbox"/> High	
*** THIS FORM IS INTENDED FOR USE AT FIELD SITE LANDING AREAS, NOT HELIPADS***					

SPOT REPORT

D-8. Table D-8 provides an example of a SPOTREP.

Table D-8, Example spot report

Spot Report
Spot reports are used to send information to provide timely intelligence or status regarding events that could have an immediate and significant effect on current planning and operations.
LINE 1: Date and time group of report.
LINE 2: Unit making report.
LINE 3: Size of enemy unit.

Table D-8, Example spot report

LINE 4: Activity of enemy at DTG or report.
LINE 5: Location of enemy activity or event observed.
LINE 6: Unit, (enemy unit).
LINE 7: Time of observation.
LINE 8: Equipment of unit observed.
LINE 9: Sender's assessment of activity.
LINE 10: Narrative of action taken by friendly forces.
LINE 11: Report Authentication.
LINE 12: Distribution of report.

CONVOY STATUS REPORT

D-9. Table D-9 provides an example of a convoy status report.

Table D-9. Example convoy status report

Convoy Status Report	
Use the following report to update convoy start point, stops en route, and RP.	
LINE 1:DTG.	
LINE 2: Unit making report.	
LINE 3: Convoy commander.	
LINE 4: Convoy unit number.	
LINE 5: Number of wheeled vehicles.	
LINE 6: Number of personnel.	
LINE 7: Route being used and alternate proposed.	
LINE 8: Starting point, include first vehicle to DTG and last vehicle DTG.	
LINE 9: Resting points.	
	a. DTG of arrival and departure at/from resting point.
	b. Number of vehicles arrived and number of vehicles departing.
	c. Number of personnel arrived and number of personnel departing.
LINE 10: RP including DTG of first vehicle to cross and last vehicle to cross RP.	
LINE 11: CP.	
LINE 12: Convoy closing DTG.	
LINE 13: Accidents/breakdowns.	
	a. Type/bumper number/unit of broken down vehicles/equipment.
	b. Location or broken vehicles/equipment.
	c. Estimated time to continue operations.
LINE 14: Sensitive items status.	
LINE 15: Narrative/remarks.	
LINE 16: Authentication.	

WEATHER ADVISORY/WATCH (WEATHERWATCH) REPORT

D-10. Table D-10 provides an example of a weather advisory/watch report.

Table D-10. Example weather advisory/watch report

Weather Advisory/Watch [Weather Watch] Report	
Use to send flash weather information that will effect current unit operations.	
LINE 1: DTG.	
LINE 2: Unit making report.	
LINE 3: Report line.	
LINE 4: Summary of Warning.	
LINE 5: Time of watch (DTG from-to DTG as of DTG of watch).	
LINE 6: Area Effected.	
LINE 7: Narrative/remarks, free text for additional information required for clarification of report.	
LINE 8: Report Authentication.	

RAIL LOAD STATUS REPORT

D-11. Table D-11, page D-12, provides an example of a rail load status report.

Table D-11. Example rail load status report

<i>Rail Load Status Report</i>
Use the following report to update rail upload and download status.
Unit making the report.
DTG of report.
LINE 1: DTG loading or off loading began.
LINE 2: DTG loading or off loading completed.
LINE 3: Loading or off loading railhead commander.
LINE 4: Loading or off loading railhead location.
LINE 5: Number of wheeled vehicles loaded or off loaded.
LINE 6: Other cargo loaded or off loaded (specify).
LINE 7: Number of passengers by grade including train guards.
LINE 8: Estimated pull or arrival DTG.
LINE 9: Rail destination.
LINE 10: Remarks.

CLOSURE REPORT

D-12. Table D-12 provides an example of a closure report.

Table D-12. Example closure report

<i>Closure Report</i>
Use to inform commander of status of movement and capability of the unit to conduct future operations. Submit upon completion of movement or as directed by commander.
LINE 1: DTG
LINE 2: Unit making report.
LINE 3: Start point grid point and DTG.
LINE 4: RP grid point and DTG.
LINE 5: CP location.
LINE 6: Closing DTG.
LINE 7: Accidents/incidents/enemy activity encountered.
LINE 8: Estimated time unit will be reconstituted and ready to continue operations.
LINE 9: Sensitive items status, include detailed lost items report and action being taken.
LINE 10: Remarks.
LINE 11: Report authentication.

AIRCRAFT SLANT REPORT

D-13. Table D-13 provides an example of an aircraft slant report.

Table D-13. Example aircraft slant report

<i>Aircraft Slant Report</i>
Use the following report to keep the battalion CP informed of the company's current aircraft availability. Typically the report is sent in the AM (0800 hours) and the PM (2000 hours) or when there is a significant change in the aircraft status.
LINE 1: Unit making the report.
LINE 2: Aircraft type.
LINE 3: Current operational readiness rate.
LINE 4: Current aircraft down and estimated time up.
LINE 5: Remarks.

PERSONNEL DAILY SUMMARY REPORT

D-14. The personnel daily summary (PDS) report (table D-14) is submitted to give a view of overall personnel strengths, and changes to personnel strengths from the previous report. A consolidated crew status of major weapons systems is also reported.

D-15. The report covers a 12 hour time period and is cumulative. It is submitted twice daily AM and PM.

Table D-14. Example personnel daily summary report

Personnel Daily Summary Report	
Required information:	
	Consolidated strength-
	Required strength, required strength on MTOE.
	Previous strength, strength reported from last PDS.
	Replacements, replacement Soldiers from higher HQ.
	RTD/ATCH, returned to duty Soldiers.
	KIA/WIA/MIA, killed/wounded/missing in action.
	DNBI, disease/nonbattle injury.
	ADMIN, administrative losses.
	Current Strength, previous strength + gains – losses.
	Required and assigned strength by MOS and grade.
	Junior grade officers (O1-O3).
	Warrant officers (W1-W4).
	Senior enlisted (E7-E9).
	Junior NCOs (E5-E6).
	Junior enlisted (E1-E4).
	Significant remarks to explain drastic strength changes.

MEACONING, INTRUSION, JAMMING, INTERFERENCE REPORT

D-16. Table D-15 provides an example of a meaconing, intrusion, jamming, and interference report.

Table D-15. Example meaconing, intrusion, jamming, interference report

Meaconing, Intrusion, Jamming, Interference Report	
Type:	
	Meaconing.
	Intrusion.
	Jamming.
	Interference.
Affected stations (call signs).	
Location(s).	
Frequency.	
Type of equipment affected.	
Type of interference.	
Strength of interference.	
Date and time interference started and stopped.	
Remarks.	

MEDICAL EVACUATION NINE-LINE REPORT

D-17. Table D-16 provides an example of a medical evacuation nine-line report.

Table D-16. Example medical evacuation nine-line report

Medical Evacuation Nine-Line Report	
LINE 1: Location of pickup site (full grid ie 34T EN43532501):	
LINE 2: Frequency/call sign at pickup site (30.75 is mandatory): 30.750	
	Call sign of personnel at pick up site.
LINE 3: Number of patients by precedence.	
	Urgent – to save life, limb, or eyesight within two hours. Evacuate within 2 hours.
	Urgent surgery – must receive surgical care within 2 hours.
	Priority – evacuate within 4 hours.
	Routine – evacuate within 24 hours.
LINE 4: Special equipment (circle one if needed):	
	None.
	Hoist.
	Extraction equipment.
	Ventilator.
LINE 5: Number of patients by type:	
	L: Number of litter patients.
	A: Number of ambulatory patients.
LINE 6: Security of pickup site:	
	N: no enemy troops.
	P: possible enemy troops.
	E: enemy troops in area (caution).
	X: enemy troops in area (armed escort required).
LINE 7: Method of marking pickup site:	
	Panels.
	Pyrotechnics.
	Smoke signals.
	None.
	Other: _____
LINE 8: Patient nationality and status:	
	United States military.
	United States civilian.
	Non-United States military, specify _____
Medical Evacuation Nine-Line Report	
	Non-United States civilian, specify _____
	EPW, nationality _____
	Other, specify _____
LINE 9: PZ CBRN status (wartime) terrain description (peacetime).	

UNEXPLODED ORDINANCE REPORT

D-18. Table D-17 provides an example of an unexploded ordinance report.

Table D-17. Example unexploded ordinance report

Unexploded Ordinance Report	
LINE 1: DTG item was discovered.	
LINE 2: Reporting unit and location (grid or directions from landmark).	
LINE 3: Contact method between witness and responding EOD team (radio frequency, call sign, point of contact, phone number, meeting place, etc.).	
LINE 4: Type of ordnance (dropped, placed, projected, or thrown). Give short description of item and quantity, if more than one.	
LINE 5: CBRN contamination in the area. Be as specific as possible.	
LINE 6: Resources threatened. Facilities, routes, etc.	
LINE 7: Impact on mission. How the threat from the UXO affects your mission.	
LINE 8: Protective measures that you have taken to protect personnel or equipment.	
LINE 9: Recommended priority for response by EOD technicians. Priorities:	
	IMMEDIATE—When the UXO stop's the unit's maneuver and mission capability or threatens critical assets vital to the mission.
	INDIRECT—When the UXO slows the maneuver or mission capability or threatens critical assets important to the mission.
	MINOR—When the UXO reduces the unit's maneuver and mission capability or threatens noncritical assets of value.
	NO THREAT—When the UXO has little or no affect on the unit's mission or assets.

EXAMPLE COMPANY WARNO

D-19. Table D-18 provides an example of a company WARNO.

Table D-18. Example of a company warning order

AIR MISSION COMMANDER			
Task Org			
Sit Overview			
Proposed Mission			
1. SITUATION			
a. Enemy Forces (CELL 1)			
Unit		Task	
		Purpose	
Most dangerous COA			
Most likely COA			
AIR MISSION COMMANDER			
b. Friendly Forces (CELL 3-Air Mission Commander)			
Battalion Msn			
Battalion Intent			
c. Weather and Terrain (CELL 2)			
2. MISSION (CELL 3-AIR MISSION COMMANDER)			
a. (2) Fires (CELL 4)			
b. Tasks to Maneuver Units (CELL 3)			

Table D-18. Example of a company warning order

AIR MISSION COMMANDER						
c. Tasks to Maintenance Team						
A/C Required		Hours Required				
Preflight Time		Weapons Configuration				
T/O		RTB				
Rotor Stables		Aux Requirement				
d. Coordinating Instructions (CELL 5)						
4. SERVICE SUPPORT (CELL 6)						
5. COMMAND & SIGNAL (CELL 7)						
a. Command						
Key Leader Locations	Bn CDR	XO	S-3	CSM	Co CDR	1SG
b. Signal (Brief Commo Card)						
6. Risk Assessment (CELL 3)						
7. AMC						
Questions						
Next Critical Time						

EXAMPLE OF AN COMPANY/TROOP OPORD

D-20. Table D-19 provides an example of an OPORD.

Table D-19. Example company/troop operation order

Mission Briefing	
<p>Roll call</p> <p style="padding-left: 40px;">Hold all questions until the end of the briefing</p> <p>Time hack</p> <p>Packet inventory</p> <p>References: maps and charts</p> <p>Task organization: aircraft/aircrew mix, team composition</p>	
<u>I. SITUATION:</u>	
<p>a. Enemy Forces</p> <p style="padding-left: 40px;">(1) Location and activity</p> <p style="padding-left: 40px;">(2) Strength and composition</p> <p style="padding-left: 40px;">(3) Weapons and equipment</p> <p style="padding-left: 40px;">(4) Most likely course of action</p> <p style="padding-left: 40px;">(5) Most dangerous course of action</p>	
<p>b. Friendly Forces</p> <p style="padding-left: 40px;">(1) Higher (BDE/BN CDR's Intent)</p> <p style="padding-left: 40px;">(2) Adjacent</p> <p style="padding-left: 40px;">(3) Supported</p> <p style="padding-left: 40px;">(4) Supporting</p> <p style="padding-left: 40px;">(5) Other aviation elements in area of operations</p>	
<p>c. Attachments and Detachments:</p>	
<p>d. Weather:</p>	

Table D-19. Example company/troop operation order

<ul style="list-style-type: none"> (1) Current weather and light data (2) Forecast weather (3) Special environmental considerations or hazards (4) Published weather minimums for operations e. Terrain f. NOTAMS
<p>II. MISSION: (Who, What, When, Where, and Why)</p>
<p>III. EXECUTION:</p> <ul style="list-style-type: none"> a. Concept of operation (overlay) (Company Commanders Intent) <ul style="list-style-type: none"> (1). Scheme of maneuver (Include ground maneuver plan) (2) Fire support (3) CAS (4) SEAD plan (5) Threat risk assessment/ASE plan b. Specific instructions to subordinate units. c. Coordinating instructions <ul style="list-style-type: none"> (1) CCIR (2) Times (posted on execution matrix) <ul style="list-style-type: none"> Preflight Rehearsal Update brief Start Communication check Lineup Takeoff On-station Relief-on-station (3) Routes (brief AMPS data/graphics) <ul style="list-style-type: none"> Ingress/egress (primary/alternate) <ul style="list-style-type: none"> Formations Altitude, airspeed Movement techniques (4) Aircraft lighting (5) Actions of contact (6) Passage of lines (7) IFF on/off line (8) PR Plan/SERE (9) Weapons status (10) ROE (11) ACO data (12) Abort criteria / bump plan (13) Engagement / bypass criteria (14) Inadvertent IMC procedures (15) Special-mission equipment

Table D-19. Example company/troop operation order

- (16) MOPP level
- (17) ADA status
- (18) MEDEVAC procedures/CASH location
- (19) Post mission actions

IV. SERVICE SUPPORT:

- a. Supply
 - (1) Class I
 - (2) FARP information
 - (3) Aircraft load (ammunition/fuel)
- b. Service and Transportation
 - (1) Aircraft maintenance status
 - (2) Location of AVUM/contact teams
 - (3) Recovery of aircraft

V. COMMAND AND SIGNAL:

- a. Command
 - (1) Chain of Command
 - (2) Team Leads
- b. Signal (Brief comms card)
 - (1) Communication sets and changeover time
 - (2) IFF
 - (3) Prowords to be used
 - (4) Lost communications procedures
 - (5) Challenge and password

WHAT ARE YOUR QUESTIONS?

BACKBRIEF

FLOUNDER REPORT

D-21. Table D-20, page D-19, provides an example of a flounder report.

Table D-20. Example of flounder report

Flounder Report	
Initial Report	
1	Location and type of aircraft
2	Injuries requiring immediate attention
3	Reason aircraft went down
Follow-on Report	
4	Tail number of aircraft
5	DTG aircraft went down
6	Proword: Sierra=secured November=not secured
7	Call sign of downed aircraft
8	Personnel: <ul style="list-style-type: none"> • Number on board • Number WIA/KIA/MIA • Perched=Survivors at site • Flown Coop=Survivor's E & E'd
9	Aircraft Status: <ul style="list-style-type: none"> • Damage assessment • COMSEC status
10	Threat situation at site
11	Call sign of sender
12	Remarks

Sample

Appendix E

Aircraft Characteristics

This appendix provides an overview of basic characteristics and capabilities of aircraft organic to attack reconnaissance battalions/squadrons.

SECTION I – OH-58D(R) KIOWA WARRIOR

E-1. The primary roles of this aircraft are armed reconnaissance and attack. The OH-58D aircraft discussed herein are the version addressed with affectivity code “R” in TM 1-1520-248-10.

DESCRIPTION

E-2. The OH-58D is a single-engine, dual-seat, armed observation aircraft. It has an improved master controller processing unit system providing highly integrated communication, navigation, aircraft, and mission equipment subsystems. The video crosslink can store compressed images in memory and enables transmission of video images between aircraft. The mast-mounted sight (MMS) contains a suite of sensors including a high-resolution television camera, IR thermal imaging, laser rangefinder, laser designator, and videotape recorder. Table E-1 outlines OH-58D aircraft characteristics.

Table E-1. OH-58D characteristics

Specifications:	
	Length: 41 ft 2.4 in Height: 12 ft 10.6 in Fuselage width (w/weapons pylons): 9 ft 2 in Main Rotor Diameter: 35 ft Max Speed (Level): 110 kts Max Gross Wt: 5500 lbs (5200 lbs by interim statement of airworthiness qualification) Cruise Airspeed: 90 kts* Combat Radius: 120 km*
Armament:	
	Missile range (Hellfire): 8,000 m Missile range (ATA Stinger): 5,000 m Rocket range (Hydra 70): 6,000m (Airburst), 8000m (Contact)
Gun Range (.50 Cal):	
	2000 m (1600 m tracer burnout)
Optics - MMS:	
	Thermal Imaging System: Detection 10+ km Recognition 6-7 km Identification 3 km
Television Sensor:	
	Detection 8+km Recognition 7 km Identification 4-6 km
Laser Range Finder/Designator:	
	Maximum ranging distance 9.99 km. Lasing a known point will update the navigation system. Maximum designating distance limited only by thermal imaging system/television sensor.
Navigation Equipment:	
	Inertial Navigation System (INS)/GPS. Can slave MMS to grid input by operator.
* varies with environmental/mission conditions	

CAPABILITIES

E-3. The OH-58D provides the following:

- Day, night, battlefield obscurant, and limited adverse-weather fighting capabilities.
- Data transfer system permitting upload from AMPS DTM and downloading of selected postmission data.
- Countermeasure suite of IR jammers, radar warning receivers, and laser warning detectors.
- Moving map display.
- Video recording and cockpit playback of television and thermal imagery from the mission.
- Advanced navigation and mission planning equipment; transportable in the C-130, C-141, C-5, and C-17.

ARMAMENT SYSTEMS

E-4. The OH-58D armament capabilities consist of a .50-caliber machine gun, 2.75-inch rockets, Hellfire missiles, and Stinger air-to-air missiles. These systems are mounted on two universal weapons pylons. The aircraft has a laser rangefinder/designator used to designate for the weapons system as well as provide range-to-target information for onboard weapons systems. Additionally, the OH-58D utilizes an AIM-1 IR Laser Aiming Light as an aiming device for night combat engagements. The AIM-1 can also be utilized to identify and/or confirm enemy targets.

.50-Caliber Machine Gun

E-5. The machine gun is an air-cooled, belt fed, recoil operated, electronically controlled weapon. The gun is mounted in a fixed position to the universal weapon pylon on the left side of the aircraft. It is capable of firing 750-850 rounds per minute at a maximum effective range of 2000m. The ammunition feed and storage system holds approximately 500 rounds.

2.75-Inch Rocket System

E-6. The 2.75-inch weapon system is a light assault weapon for use against enemy personnel, light armored vehicles, and other soft-skinned targets. The system is comprised of one or two 7-shot rocket launcher(s) and may be installed on one or both sides of the aircraft. This area system can launch multiple rockets with various warhead mixes including high explosive, high-explosive MPSM, white phosphorous, illumination, and flechette. The maximum range is 6000m for airburst warheads, and 8000m for contact warheads.

Hellfire Missile

E-7. The Hellfire missile system is an air-to-surface, laser guided missile system. The hellfire missile is a point target weapon system using high explosive anti-tank (HEAT) warheads to destroy armored targets and blast fragmentation and thermo-baric warheads to defeat all targets, except armor targets, utilizing blast and fragmentation. The Hellfire missile system can be comprised of one or two launchers containing up to two missiles each. However, weight restrictions may limit the aircraft to just one launcher. The minimum engagement range is 500 meters; maximum range is 8,000 meters. Laser designation may be autonomous or by remote ground or airborne designators.

Air-to-Air Stinger Missile System

E-8. The air-to-air Stinger is an IR, heat-seeking, fire-and-forget missile capable of engaging airborne targets day or night. The OH-58D can carry two Stinger missiles per pylon for a maximum of four missiles. The maximum range is more than 4,000 meters.

ARMAMENT CONFIGURATIONS

E-9. Table E-2 provides typical OH-58D ordnance loads.

Table E-2. Typical OH-58D helicopter ordnance loads

Aircraft	Gun	2.75-in Rockets	Missiles
OH-58D	500	7	
OH-58D		14	
OH-58D	500		2 air-to-air Stingers
OH-58D			4 Hellfire

E-10. Figure E-1 illustrates an example of mission load configurations. Only one system at a time may be mounted per side.

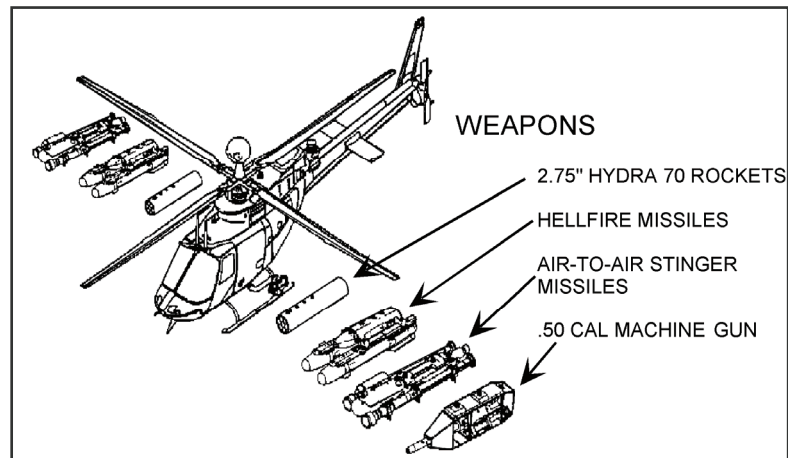
**Figure E-1. OH-58D weapons loading**

COMMUNICATIONS

E-11. The OH-58D has the following communications systems:

- Two AN/ARC-201D SINCGARS with embedded encryption and data capability. Both operate in the 30 to 87.975 MHz frequency range and have anti-jam, frequency-hopping capability.
- The AN/ARC-186 provides VHF-AM (116 to 151.975 MHz).
- The AN/ARC-164 Have Quick II provides anti-jam frequency-hopping UHF-AM communications in the 225 to 399.975 MHz range at 25 KHz intervals.
- An IDM transfers digital messages. The KY-58 provides secure communications for Have Quick II and VHF-AM/FM radios.

NAVIGATION SYSTEM

E-12. The embedded global positioning system inertial navigation system (EGI) is a self-contained, all-attitude navigation system that works with the radar altimeter and laser rangefinder/designator. Its embedded global positioning system receiver supports both pure and blended GPS, and INS solutions. The system is capable of storing waypoint and target information for making flight plan routes and altering these routes if a mission changes. EGI also provides target location in longitude and latitude or MGRS coordinates and altitude in meters or feet MSL when range, bearing, and declination to the target are provided to the navigation subsystem for the MMS.

LIMITATIONS

E-13. The following paragraphs discuss limitations of the OH-58D.

Infrared Radiation Crossover

E-14. The thermal imaging sensor operates by determining temperature differentials; when targets and their surroundings reach the same temperature, target detection degrades.

Obscurants

E-15. Some obscurants (dust, rain, haze, or smoke) can keep laser energy from reaching the target and hide it from the incoming munitions seeker.

SECTION II - APACHE (ALPHA/DELTA)

E-16. The AH-64 is a highly stable aerial weapons-delivery platform. Its primary role is to attack. It can fight to destroy, attrit, disrupt, or delay enemy forces. Armed reconnaissance and security are secondary roles.

DESCRIPTION

E-17. The AH-64 is a twin-engine, tandem-seat, aerial weapons platform. It is equipped with a Target Acquisition Designation Sight (TADS), tri-service laser designator/range finder,, and a Pilot Night Vision Sensor (PNVS) allowing the two-man crew to navigate and attack at night at extended standoff ranges, and in some adverse weather conditions. The Apache has a full range of ASE and can withstand a hit from rounds as large as 23-millimeters in some critical areas.

E-18. The AH-64D is a remanufactured AH-64A. Its improved navigation system integrates dual INS/GPS and Doppler radar for acceleration cueing. Some Longbow models are equipped with a millimeter wave fire control radar (FCR) allowing the helicopter to identify, classify, prioritize, and track certain targets to the maximum range of the Hellfire weapon system. Table E-3 compares Apache aircraft specifications. Table E-4 details AH-64D characteristics.

Table E-3. Comparison of Apache specifications

<i>Model</i>	<i>AH-64A</i>	<i>AH-64D w/o Radar</i>	<i>AH-64D Longbow</i>
Length (ft)	57.67	57.67	57.67
Height (ft)	15.25	13.33	16.08
Width (ft)	17.17	15.50	15.05
Main Rotor Span (ft)	48	48	48
Max Gross Wt (lbs)	21,000	23,000	23,000
Cruise Speed (kts)	120*	130*	130*
Combat Radius (km)	200*	200	200
Combat Radius w/One 230-Gallon Aux Fuel Tank (km)	350*	350*	350*
Self-Deployability	Yes	Yes	Yes
*Varies with a multitude of factors such as temperature, wind, gross weight, and mission-specific time requirements.			

Table E-4. AH-64D characteristics

Armament:	
	Maximum autonomous Hellfire missile range: 7,000m Maximum remote designated Hellfire missile range: 8,000m 2.75" Rocket hover fire most effective dispersion pattern: 3,000 – 5,000m for MPSM and unitary warhead 2.75" Rocket running/diving fires in CCA accuracy degrades beyond 1000-1200m Maximum 30mm Gun range: 4,000 m Maximum effective gun range from a hover using TADS: 1500 point targets, 3000m area targets Running/diving fires in CCA accuracy degrades beyond 800-1000m
Optics:	
	TADS/Day TV (Low Light, Daytime) Allows autonomous laser designation of tank size target with image auto tracker at 6000m, 4000m using manual tracking TADS/FLIR (day, night, weather, obscurants) Allows autonomous laser designation of tank sized target with image auto tracker at 3500m, 3000 using manual tracking. PNVs (night, weather, obscurants) MTADS (2nd gen FLIR) greatly increases TADS capability to detect and identify, not available on all AH-64D aircraft.
Navigation Equipment:	
	Dual EGI/GPS, Doppler radar, ADF
Flight Characteristics:	
	Max speed in level flight is a function of environmental conditions, aircraft weight and engine capabilities and will not normally exceed 140-145 Kts.. Normal cruise speed: 110 - 120 kts
Additional Capabilities:	
	Aircraft can be configured with up to four 230 gallon external fuel tanks for ferrying/self-deployment missions. Use of IZLID laser for AGI to allow ground units to view laser through NVDs. Can be configured with Roberson internal fuel tank to increase flight range by 45-55 minutes.
Limitations:	
	Threat ID; IR crossover; Weather may inhibit Hellfire engagements (seeker must be able to "see" the laser designated spot); overwater operations severely degrade navigation system; PNVs cannot detect wires or other small obstacles. TADS and PNVs FLIR quality can be severely degraded by weather conditions that will not normally affect ground maneuver forces, i.e. rain, fog, snow. Aircrews may or may not have NVG capability.

Fire-Control Radar

E-19. The Apache Longbow system consists of an integrated millimeter wave FCR, along with a Radio Frequency Interferometer (RFI). The FCR enables Apache Longbow helicopters to detect, classify, prioritize, and engage targets with RF Hellfire missiles without visually acquiring the target. Apache Longbow crews may also employ RF Hellfire missile during poor visibility when laser, optical, and FLIR sensors are degraded. The FCR will not identify friend or foe, however the RFI can detect and identify radar systems and display targeting information on the same screen as the information from the FCR.

E-20. Apaches equipped with the Longbow system are denoted as either AH-64D with radar or AH-64D Longbow. The Longbow is equipped with FCR, a radar frequency interferometer, and upgraded 701C engines to compensate for the additional weight of the Longbow system. The Longbow system is integrated with the TADS to allow simultaneous and autonomous operation of the TADS and the FCR.

Without Radar

E-21. The AH-64D without radar includes all preceding Longbow aircraft upgrades except an FCR, a radar frequency interferometer system, and their associated black boxes. The aircraft may not have the improved 701C engine installed. The AH-64D without radar can be converted to an AH-64D with radar upon installation of the Longbow system and 701C engines. The AH-64D without radar can fire the RF Hellfire

missile autonomously (with LOS to the target) or by using FCR targeting data handed over from an AH-64D with radar.

CAPABILITIES

E-22. The AH-64 provides the following:

- Precision attacks during day or night, or when the battlefield is obscured (Longbow).
- Wide array of firepower options.
- Detection, classification, and prioritization of stationary and moving ground and airborne targets (Longbow).
- Robust suite of EW systems.
- Lethal destruction of enemy ADs.
- Real-time SA and intelligence of the battlefield to the digitized aviation/ground commander; data transfer system to upload from the AMPS data-transfer cartridge and download postmission data.
- HF radio for NOE long-distance NLOS communications.

ATTACK HELICOPTER ARMAMENT SYSTEMS

E-23. The AH-64 can carry up to a total of 16 Hellfire laser-designated missiles on four wing store pylons, or up to a total of 76 2.75-inch folding fin aerial rockets on four wing store pylons, and up to 1,200 rounds of ammunition for its 30-millimeter cannon. Wing stores may be configured to allow both hellfire and rockets to be carried. Each pylon may carry up to 19 rockets or 8 hellfire missiles. Environmental conditions may significantly restrict weapons loads and station time associated with those loads. In addition, the use of a Roberson internal auxiliary fuel tank will limit 30mm to 300 rounds.

E-24. The Apache Longbow system enhances the rapid employment of all available weapons including Hellfire missiles, aerial rocket system, and the 30-millimeter cannon. Once the FCR detects, classifies, and prioritizes targets, the gunner selects the desired weapon for attack. This data is automatically transferred to the weapon and displayed on the selected weapon sight.

30-Millimeter Chain Gun

E-25. The M230E1 is a chain-driven area weapons system mounted to a hydraulically driven turret under the helicopter forward fuselage. It fires the United States M789 NATO standard ammunition HEDP round. Each shell contains 21.5 grams of explosive charge sealed in a shaped-charge liner. It can penetrate more than 2 inches of armor at 2,500 meters and produces antipersonnel effects within a 4-meter radius. At typical engagement ranges, HEDP ammunition will defeat BMP type targets. The AH-64 can carry 1,200 rounds of 30-millimeter ammunition. It has a rate of fire of 600 to 650 rounds per minute with a maximum effective range from a hover using TADS of approximately 1,500 meters against point targets and 3,000 meters against area targets. Running/diving fires in a CCA environment are limited by range source selection and often fired using the helmet sight at ranges of less than 1000m.

2.75-Inch Rocket System

E-26. When configured with four 19 shot rocket pods, the AH-64D can carry a maximum of 76 folding-fin aerial rockets for use against enemy personnel, light armored vehicles, and other soft-skinned targets. The system can launch multiple rockets with various warhead mixes to include; high explosive point detonating, high-explosive MPSMs, white phosphorous, red phosphorous, overt and covert illumination, and flechette. Aircrews select the quantity and type to be fired. The maximum range varies with warhead,

Hellfire Missile

E-27. The Hellfire is used primarily to destroy tanks, armored vehicles, and other hard-material targets. The AH-64A is capable of firing only the SAL Hellfire while the AH64D is capable of firing both the SAL

and RF Hellfire missiles. SAL and RF Hellfire can defeat any known armor. The minimum engagement range is 500 meters, the maximum range is 8,000 meters, and the maximum aircraft load when configured with four hellfire launchers is 16 missiles.

Semiactive Laser Hellfire

E-28. The SAL Hellfire requires a laser target designation that may be autonomous or remote

E-29. . The remote designator may offset a maximum of 60 degrees from the gun-to-target line and must not position its self within a 30 degree safety fan from the firing aircraft.

Longbow Radar Frequency Hellfire

E-30. The Longbow RF Hellfire is a millimeter wave guided missile and a true fire-and-forget weapon. The millimeter wave radar and missile can engage targets through weather and battlefield obscurants. The RF missile receives targeting information—to include north, east, and down data—from the acquisition source: TADS, FCR, or another aircraft. Targeting data can be transferred from a Longbow to an AH-64D without radar as a radar frequency handover.

MISSION CONFIGURATIONS

E-31. Table E-5 is a matrix of AH-64D mission profiles and typical ammunition loads (weight limits may require reduction in mission loads).

Table E-5. AH-64D weapons loads, weights, and radius

Weapons:	A	B	C		Weights & Radius: (110 kts airspeed)	A	B	C
Hellfire	8	16	12		Operate	13897	14009	13953
Rockets	38	0	19		Fuel	2870	2870	2870
30mm	340	340	340		Load	2103	1862	1982
					T/O	18870	18741	18805
					Radius KM	210.6	210.6	210.6
					Radius NM	113.7	113.7	113.7
					Endurance	2.23	2.23	2.23

COMMUNICATIONS

E-32. The AH-64D has the following communications systems:

- The AN/ARC-201D SINCGARS with embedded encryption and data capability (operates in the 30 to 87.975 MHz frequency range and has anti-jam, frequency-hopping capability).
- The AN/ARC-164 Have Quick II provides anti-jam frequency-hopping UHF-AM communications in the 225 to 399.975 MHz range at 25 KHz intervals.
- The AN/ARC-186 provides VHF-AM (116 to 151.975 MHz).
- The AN/ARC-220 HF radio provides NOE long-range communications in the 2 to 29.999 MHz range and secure mode when employed with the KY-100.
- The TSEC/KY-100 provides secure communications for the AN/ARC-220 HF radio.
- The TSEC/KY-58 interfaces with AN/ARC-201D and AN/ARC-201 radios to provide secure voice for these radios.
- The IDM transfers digital messages.
- Some aircraft may have a second SINCGARS radio in place of the HF radio

NAVIGATION SYSTEMS

E-33. The navigation subsystem consists of the following major components:

- Embedded global positioning system inertial navigation system (EGI, primary and backup).
- Doppler radar velocity sensor.

- Radar altimeter.
- Automatic direction finder (ADF).
- High integrated air data computer.
- Flight management computer.

LIMITATIONS

E-34. Prominent limitations of the AH-64 are discussed in the following paragraphs.

Threat Identification

E-35. Threat identification through the FLIR system is extremely difficult; although the crew can easily find the heat signature of a vehicle, it may not be able to determine whether it is friend or foe. FCR target identification is limited to radar cross section return data and does not determine actual target validity.

Infrared Radiation Crossover

E-36. The thermal imaging sensor and PNVIS operate by determining temperature differentials. When targets and their surroundings reach the same temperature (normally twice a day), target detection is degraded; these conditions also make flight difficult while using the FLIR sensor. The same effect occurs when temperatures do not significantly vary throughout the day or night, or heavy cloud cover exists for long periods of time. For example, sustained rainfall may reduce the FLIR quality to unusable for flight or targeting during certain times of the year.

Obscurants

E-37. Some obscurants (such as dust, rain, haze, or smoke) can prevent laser energy from reaching the target. It also hides the target from incoming munitions seekers for SAL Hellfire and prevents effective use of FLIR systems. AH-64D FCR and RF Hellfire see and shoot through obscurants.

Low Cloud Ceilings

E-38. Determination of the SAL Hellfire's maximum employment range requires consideration of cloud ceilings. Depending on range to target, trajectory mode selected, and lasing techniques, the missile may climb into low cloud ceilings causing the seeker to break track from the laser spot or preventing the seeker from acquiring the laser spot.

Instrument Flight Rules

E-39. The AH-64D is not currently certified for IFR operations.

SECTION III – ARMED RECONNAISSANCE HELICOPTER

E-40. The armed reconnaissance helicopter (ARH) has been selected to replace the OH-58D during force modernization. Table E-5 provides operational characteristics of the ARH.

Table E-6. Armed reconnaissance helicopter characteristics

Specifications	
	Length: 41 feet 4 inches
	Height: 10 feet 11 inches
	Fuselage width (w/weapons pylons): 9 feet 5 inches
	Main Rotor Diameter: 35 feet
	Max Speed (Level): 140 knots
	Max Gross Wt: 6250 pounds
	Cruise Airspeed: 113 knots*
	Combat Radius: 300 kilometers

Armament	
	Missile Range (Hellfire): 8,000 meters Rocket Range (Hydra 70): 6,600-9,000 meters
Gun Range (.50 Caliber)	
	2,000 meters (1600 meters tracer burnout)
Optics (FLIR)	
	FLIR: Detection: 10+ kilometers Recognition: 8+ kilometers Identification: 5 kilometers
	Television Sensor: Detection: 10+ kilometers Recognition: 8 kilometers Identification: 4-6 kilometers
	Laser Range Finder/Designator: Maximum Ranging Distance: Classified Commander's pointer Eye Safe Laser (Range Only) AIM-1 Laser boresighted to weapons Constantly Computed Impact Point Lasing a known point will update the navigation system.
	Pilots use AN/AVS-6 to fly the aircraft at night.
Navigation Equipment	
	INU/INS/GPS Slave sights to grid input by operator. Spiral technology will allow user to look out door and slace sight to specific point. Full suite for navigation including TACAN/VOR/ILS/GATM and EGI approaches and departures.
Additional Capabilities	
	Helmet Display Tracking System Automatic Flight Control System Common Avionics Architecture System Common Missile Warning System Extended Range Upgraded engine provides 970 SHP
Limitations	
	*Varies with environmental/mission conditions.

ARMAMENT SYSTEMS

E-41. ARH armament capabilities consist of a .50-caliber machine gun, 2.75-inch rockets, and Hellfire missiles. These systems are mounted on two universal weapons pylons. The aircraft has a laser rangefinder/designator used to designate for the weapons system as well as provide range-to-target information for onboard weapons systems.

.50-CALIBER MACHINE GUN GAU-19

E-42. This electronically controlled weapon can be mounted in a fixed position on the left weapons pylon. It is an area weapon system with a maximum effective range of 2000 meters (tracer burnout 1600 meters). The GAU-19 is a 3-barrelled Gatling type machine gun. Ammunition capacity is 500 rounds.

2.75-INCH ROCKET SYSTEM FOLDING FIN AERIAL ROCKET

E-43. The ARH can carry two seven-shot rocket pods with a maximum load of 14 rockets for use against enemy personnel, light armored vehicles, and other soft-skinned targets. This area system can launch multiple rockets with various warhead mixes including high explosive, high-explosive MPSMs, white phosphorous, illumination, and flechette. Spiral technology will be introduced with more than seven shots per side. APKWS will also enable a better PK percentage using these rockets.

HELLFIRE MISSILE

E-44. The SAL Hellfire is used primarily for destruction of tanks, armored vehicles, and other hard-material targets. The ARH can carry two two-missile launchers for a maximum of four missiles. The minimum engagement range is 500 meters; maximum range is 8,000 meters. Laser designation may be autonomous or remote.

COMMUNICATIONS

E-45. The ARH has the following communications systems:

- Two AN/ARC-201D SINCGARS with embedded encryption and data capability. Both operate in the 30 to 87.975 MHz frequency range and have antijam, frequency-hopping capability.
- An IDM/JVMF transferring digital messages.
- Two AN/ARC-231s, one having the capability to transmit and receive SATCOM, while both have one of four separate tuneable bands, including FM/VHF/UHF. Have Quick II and FM secure are also additions to the aircraft.

LIMITATIONS

E-46. The following are possible ARH limitations:

- **Obscurants.** Some obscurants (dust, rain, haze, or smoke) can keep laser energy from reaching the target and hide the target from the incoming munitions seeker.
- **Low cloud ceilings.** Consideration must be given to cloud ceilings determining maximum employment range of the SAL Hellfire. Depending on distance to target, trajectory mode selected, and lasing techniques, the missile may climb into low cloud ceilings causing the seeker to break track from the laser spot or preventing the seeker from acquiring the laser spot.
- **Hellfire remote designation constraints.** The designating crew may offset a maximum of 60 degrees from the gun-to-target line and must not position its aircraft within a +30-degree safety fan from the firing aircraft.
- **Instrument meteorological conditions.** The ARH will be certified but not qualified with the FAA.

Appendix F

Reference Library

This appendix provides a quick reference list of documents available to help with all aspects of possible battalion/company tasks and responsibilities. All publications are on a recurring review and rewrite schedule and some references may have new number and title names; however, this appendix provides the latest published publications available at the time of print. These publications are available for downloading at www.apd.army.mil.

SECTION I – PUBLICATIONS

ARMY TRAINING AND EVALUATION PROGRAM, MISSION TRAINING PLAN

F-1. Army training and evaluation program (ARTEP) MTPs are used to help develop an objective training plan for the unit which the higher headquarters can evaluate task and mission accomplishment using prepared evaluation checklists.

- ARTEP 1-111-MTP. Provides MTP for aviation brigades.
- ARTEP 1-113-MTP. Provides MTP for assault helicopter battalions.
- ARTEP 1-118-MTP. Provides MTP for GS aviation battalions.
- ARTEP 1-126-MTP. Provides MTP for attack reconnaissance helicopter battalions/squadrons.
- ARTEP 1-245-MTP. Provides MTP for heavy helicopter battalions.
- ARTEP 1-425-MTP. Provides MTP for ATS battalion.
- ARTEP 1-500-MTP. Provides MTP for intermediate maintenance battalion and company, now the ASB and ASC.

TRAINING CIRCULARS

F-2. TCs provide guidance to the commander on establishing training requirements and procedures for individual and crew tasks.

- TC 1-210. ATP commander's guide to individual and crew standardization. Provides the commander with established requirements to determine and conduct required aircrew training common to all aviators and crews.
- TC 1-218. ATM for the utility airplane, C-12, aviator and crew. Provides the commander with established requirements to determine training requirements for all C-12 aviators to progress and maintain proficiency in all tasks expected to be performed by the C-12 crew.
- TC 1-219. ATM for the Guardrail common sensor airplane, RC-12, aviator. Provides the commander with established requirements to determine training requirements for all RC-12 aviators to progress and maintain proficiency in all tasks expected to be performed by the RC-12 crew.
- TC 1-228. ATM for the Kiowa and Cayuse observation helicopters, OH-58A/C and OH-6 respectively, aviator. Provides the commander with established requirements to determine training requirements for all OH-58A/C and OH-6 aviators to progress and maintain proficiency in all tasks expected to be performed by the OH-58A/C and OH-6 crew.

- TC 1-237. ATM for the utility helicopter, H-60 series, aviator and crew. Provides the commander with established requirements to determine training requirements for all UH-60 aviators to progress and maintain proficiency in all tasks expected to be performed by the UH-60 crew.
- TC 1-238. ATM for the Apache AH, AH-64A, aviator. Provides the commander with established requirements to determine training requirements for all AH-64A aviators to progress and maintain proficiency in all tasks expected to be performed by the AH-64A crew.
- TC 1-240. ATM for the Chinook cargo helicopter, CH-47D, aviator and crew. Provides the commander with established requirements to determine training requirements for all CH-47D aviators to progress and maintain proficiency in all tasks expected to be performed by the CH-47D crew.
- TC 1-248. ATM for the Kiowa Warrior observation helicopter, OH-58D, aviator. Provides the commander with established requirements to determine training requirements for all OH-58D aviators to progress and maintain proficiency in all tasks expected to be performed by the OH-58D crew.
- TC 1-251. ATM for the Apache AH, AH-64D, aviator. Provides the commander with established requirements to determine training requirements for all AH-64D aviators to progress and maintain proficiency in all tasks expected to be performed by the AH-64D crew.
- TC 1-600. ATM and commander's guide for UAS. Provides the commander with established requirements to determine training requirements for all operators in all tasks expected to be performed by UAS operators.

SOLDIER TRAINING PUBLICATION

F-3. The Soldier training publication (STP) is a Soldier's manual (SM) and trainer's guide (TG) providing information to leadership on required training for specific MOSs and skills required to attain and maintain the established level of proficiency expected of a Soldier at each grade within the military occupational specialty (MOS).

- STP 1-93C1-SM-TG. SM and TG for MOS 15Q, (formerly 93C) air traffic controller, skill level 1. Provides the commander with established requirements to determine training requirements for all 15Q school trained Soldiers to progress and maintain proficiency in all tasks expected to be performed.
- STP 1-93C24-SM-TG. SM and TG for MOS 15Q, (formerly 93C) air traffic controller, skill levels 2/3/4. Provides the commander with established requirements to determine training requirements for all 15Q school trained Soldiers to progress and maintain proficiency in all tasks expected to be performed.
- STP 1-93P1-SM-TG. SM and TG for MOS 15P, (formerly 93P) aviation operations specialist, skill level 1. Provides the commander with established requirements to determine training requirements for all 15P school trained Soldiers to progress and maintain proficiency in all tasks expected to be performed.
- STP 1-93P24-SM-TG. SM and TG for MOS 15P, (formerly 93P) aviation operations specialist, skill levels 2/3/4. Provides the commander with established requirements to determine training requirements for all 15P school trained Soldiers to progress and maintain proficiency in all tasks expected to be performed.
- STP 1-15D13-SM-TG. SM and TG for MOS 15D, aircraft power train repairer skill levels 1 & 3. Provides the commander with established requirements to determine training requirements for all 15D school trained Soldiers to progress and maintain proficiency in all tasks expected to be performed.
- STP 1-15M13-SM-TG. SM and TG for MOS 15M, UH-1 helicopter repairer skill levels 1/2/3. Provides the commander with established requirements to determine training requirements for all 15M school trained Soldiers to progress and maintain proficiency in all tasks expected to be performed.

- STP 1-15T13-SM-TG. SM and TG for MOS 15T, UH-60 helicopter repairer skill levels 1/2/3. Provides the commander with established requirements to determine training requirements for all 15T school trained Soldiers to progress and maintain proficiency in all tasks expected to be performed.
- STP 1-15U13-SM-TG. SM and TG for MOS 15U, CH-47 helicopter repairer skill levels 1, 2 & 4. Provides the commander with established requirements to determine training requirements for all 15U school trained Soldiers to progress and maintain proficiency in all tasks expected to be performed.

FIELD MANUALS

F-4. FMs provide multitude of information specific to the subject of the FM. The FMs discussed below provide information on the organization, mission, fundamentals, communication, mission employment, combat support and combat service support operations for Army aviation and various levels and types of aviation units.

ARMY KEYSTONE FIELD MANUAL FOR ARMY AVIATION

F-5. FM 1-100 (will be revised as 3-04.100), one of the Army's keystone manuals, is the base doctrine manual for Army aviation. It provides general guidance for all aviation related missions and units and their contribution to the Army across the full spectrum of operations and environments.

AVIATION BRIGADE LEVEL FIELD MANUAL

F-6. FM 3-04.111 provides doctrinal information for leaders to understand how CABs operate in various environments and across the full spectrum of operations including maneuver, combat support, and sustainment missions.

AVIATION BATTALION LEVEL FIELD MANUAL

F-7. Battalion-level manual is FM 1-113 (will be revised as 3-04.113).

Maintenance

- F-8. Maintenance publications are—
- FM 3-04.500.
 - FM 3-04.508.
 - FM 3-04.513.
 - TM 1-1500-204-23-1.
 - EM 0126. (TM 1-1520-Apache/Longbow.)

Operations

- F-9. Operations publications are—
- Aviation Liaison Officer Handbook, United States Army Aviation Center.
 - TC 1-400.
 - AR 95-1.
 - HQDA Letter 525-03-1.
 - DA Form 5484 (Mission Schedule/Brief).
 - FM 1-02.21.
 - FM 2-0 (FM 34-1).
 - FM 3-0.
 - FM 3-01.4. J-SEAD.

- FM 3-04.104.
- FM 3-04.140.
- FMI 3-04.155.
- FM 3-04.300.
- FM 3-04.301.
- FM 3-04.303.
- FM 1-564 (will be revised as FM 3-04.564).
- FM 3-05.30.
- FM 3-05.60 (FM 1-108).
- FM 3-06 (FM 90-10).
- FM 3-06.1.
- FM 3-06.11 (FM 90-10-1).
- FM 3-07 (FM 100-23).
- FM 3-07.31.
- FM 3-09.32 (FM 90-20).
- FM 3-13 (FM 100-6).
- FM 3-21.38.
- FM 3-50.1.
- FM 3-50.3.
- FM 5-0.
- FM 6-0.
- FM 6-20 (will be revised as FM 3-09).
- FM 6-20-40.
- FM 6-20-50.
- FM 4-20.197 (will be revised as FM 4-20.197).
- FM 17-95.
- FM 34-2-1 (will be revised as FM 2-00.21).
- FM 34-60 (will be revised as FM 2-01.2).
- FM 34-130 (will be revised as FM 2-01.3).
- FM 55-450-2.
- FM 71-100 (will be revised as FM 3-91).
- FM 71-100-2.
- FM 71-100-3.
- FM 90-4 (will be revised as FM 3-18.12).
- FM 90-21 (will be revised as FM 3-09.33).
- FM 100-8 (will be revised as FM 3-16).
- FM 100-15 (will be revised as FM 3-92).
- FM 100-17-3 (will be revised as FM 4-01.8).
- FM 100-17-5.
- JP 3-0.
- JP 3-01.4.
- JP 3-09.
- JP 3-09.1.
- JP 3-09.3.
- JP 3-50.2.
- JP 3-50.21.
- JP 3-60.

Unit Movement

F-10. Unit movement publications are—

- EM 0253. (TM 55-1520-241-S).
- FM 3-35.4.
- FM 4-01.011 (FM 55-65).
- SDDCTEA Pamphlet 55-19. (Surface Deployment and Distribution Command Transportation Engineering Agency Fort Eustis, Virginia).
- SDDCTEA Pamphlet 55-20. (Surface Deployment and Distribution Command Transportation Engineering Agency Fort Eustis, Virginia).
- SDDCTEA Pamphlet 55-21. (Surface Deployment and Distribution Command Transportation Engineering Agency Fort Eustis, Virginia).
- SDDCTEA Pamphlet 55-22. (Surface Deployment and Distribution Command Transportation Engineering Agency Fort Eustis, Virginia).
- SDDCTEA Pamphlet 55-23. (Surface Deployment and Distribution Command Transportation Engineering Agency Fort Eustis, Virginia).
- SDDCTEA Pamphlet 55-24. (Surface Deployment and Distribution Command Transportation Engineering Agency Fort Eustis, Virginia).
- SDDCTEA Pamphlet 70-1. (Surface Deployment and Distribution Command Transportation Engineering Agency Fort Eustis, Virginia).
- SDDCTEA Pamphlet 700-2. (Surface Deployment and Distribution Command Transportation Engineering Agency Fort Eustis, Virginia).
- SDDCTEA Pamphlet 700-4. (Surface Deployment and Distribution Command Transportation Engineering Agency Fort Eustis, Virginia).
- SDDCTEA Pamphlet 700-5, 2001. (Surface Deployment and Distribution Command Transportation Engineering Agency Fort Eustis, Virginia).
- SDDCTEA Pamphlet 700-6, 2002. (Surface Deployment and Distribution Command Transportation Engineering Agency Fort Eustis, Virginia).
- TM 1-1520-237-S.
- TM 1-1520-248-S.
- TM 1-1520-252-S.
- TM 55-1520-238-S.
- TM 55-1560-307-13&P.
- Unit Movement Officer Deployment Handbook Reference 97-1, United States Army Transportation School, Fort Eustis, VA.

Safety

F-11. Safety publications are—

- DODD 2000.12. DOD Antiterrorism/Force Protection Program.
- Department of the Army Pamphlet (DA Pam) 385-64.
- FM 3-100.12.
- FM 100-14.
- U.S. Army Safety Center (USASC). Commander and Staff Risk Management Booklet.
- USASC. Small Unit Risk Management Booklet.

Supply

F-12. Supply publications are—

- AR 700-138.
- CTA 50-900.

- CTA 50-909.
- DA Pam 710-2-1.
- DA Pam 710-2-2.
- FM 4-0.
- FM 100-9.
- Supply Bulletin 710-1-1.

Air Traffic Services Publications

F-13. Air Traffic Services publications are—

- FM 1-120 (will be revised as FM 3-04.120).
- FM 3-52.
- FM 3-52.2 (FM 100-103-2).
- JP 3-52

F-14. The publications listed below are Federal Aviation Administration publications.

- Aeronautical Information Manual.
- Air Traffic Bulletin.
- North Atlantic International GA Operations.
- NOTAM Publication (class II).
- Pilot/Controller Glossary.
- Federal Aviation Administration Order (FAAO) 3120.4L.
- FAAO 7000.5C.
- FAAO 7010.1S.
- FAAO 7110.10S.
- FAAO 7110.65R.
- FAAO 7210.3U.
- FAAO 7210.56C.
- FAAO 7340.1Y.
- FAAO 7350.7X.
- FAAO 7400.2F.
- FAAO 7450.1.
- FAAO 7610.4K.
- FAAO 7900.5B.
- FAAO 7930.2.

Training

F-15. Training publications are—

- FM 7-0.
- FM 7-1.

Other

F-16. The following are miscellaneous publications and forms:

- DA Form 1594. Daily Staff Journal or Duty Officer's Log.
- DA Form 2028. Recommended Changes to Publications and Blank Forms.
- DA Pam 25-30.
- DA Pam 25-33.
- FM 1.

- FM 3-90.6.
- FM 7-20 (will be revised as FM 3-21.20).
- FM 8-10-26 (will be revised as FM 4-02.26).
- FM 20-3 (will be revised as FM 3-58.1).
- FM 100-13.
- JP 1-02.

SECTION II – WEBSITES

F-17. In the growing world of digital communications the World Wide Web and links found on it are an expanding source of information. The military and Soldiers in general are using the internet more everyday to communicate and locate information relating to their mission, equipment, threat and gain knowledge of operational and leadership ideas and techniques relating to garrison and operational environments. Some official web sites are—

- Reimer Digital Library—(www.train.army.mil), used to access military publications online.
- DOD Dictionary of Military Terms and Definitions—(www.dtic.mil).
- Active FM—Army Doctrine and Training Publications (www.army.mil/usapa/doctrine).
- Air War College References, on and offline—(www.au.af.mil).
- AKO—Online medium to access e-mail, publications, current events, links to other military organizations and special project groups. (www.us.army.mil).
- Army Doctrine Online—(www.doctrine.army.mil).
- Army Homepage—(www.army.mil).
- Army Publishing Directorate (APD)—Home Page (www.apd.army.mil).
- CALL—Public Web Page—Gathers and provides information on lessons learned by Soldiers conducting military operations. Information is available for downloading and provisions are established for special requests (www.call.army.mil).
- Fort Rucker—Home of Army Aviation—Online interface providing information regarding installation, Army aviation, units and directorates, current events and points of contact (www-rucker.army.mil).
- Joint Electronic Library—Welcome (www.dtic.mil/doctrine).
- TRADOC Homepage—(www.monroe.army.mil).
- Warrant Officer Career Center—(www.usawocc.army.mil).

Glossary

1SG	first sergeant
A&L	administrative and logistics
A2C2	Army airspace command and control
AA	assembly area
AAA	antiaircraft artillery
AAR	after-action review
AATF	air assault task force
ABCCC	airborne battlefield command and control center
ABCS	Army battle command system
ABF	attack by fire
ACA	airspace coordination area
ACE	air combat element
ACM	airspace coordinating measure
ACO	air control order
ACP	air control point
ACS	air cavalry squadron
ACT	air cavalry troop
AD	air defense
ADA	air defense artillery
ADU	air defense unit
ADVON	advanced party
AFTTP	Air Force tactics, techniques, and procedures
AGL	above ground level
AH	attack helicopter
AHT	assault helicopter troop
AKO	Army Knowledge Online
ALO	air liaison officer
ALSE	aviation life support equipment
ALSO	aviation life support officer
ALSS	aviation life support system
AMC	air mission commander
AMCOM	Aviation and Missile Command
AMO	aviation materiel officer
AMPS	aviation mission planning system
AMSS	Army materiel status system
ANCD	automated net control device
ANGLICO	air and naval gunfire liaison company
AO	area of operations

Glossary

AOR	area of responsibility
APC	armored personnel carrier
AR	Army regulation
ARB	attack reconnaissance battalion
ARC	attack reconnaissance company
ARMS	aviation resource management survey
ARH	armed reconnaissance helicopter
ARP	airframe repair platoon
ARS	attack reconnaissance squadron
ART	attack reconnaissance troop
ARTEP	Army training and evaluation program
ASB	aviation support battalion
ASC	aviation support company
ASE	aircraft survivability equipment
ASL	authorized stockage list
ASOC	air support operations center
ATACMS	Army Tactical Missile System
ATF	aviation task force
ATGM	antitank guided missile
ATHP	ammunition transfer holding point
ATM	aircrew training manual
ATO	air tasking order
ATP	aircrew training program
ATS	air traffic services
AWACS	Airborne Warning and Control System
BAE	brigade aviation element
BAS	battalion aid station
BCD	battlefield coordination detachment
BCM	basic combat maneuver
BCT	brigade combat team
BDA	battle damage assessment
BDAR	battle damage assessment and repair
BHO	battle handover
BMNT	begin morning nautical twilight
BP	battle position
BSA	brigade support area
BUB	battle update briefing
C2	command and control
CA	civil affairs
CAB	combat aviation brigade

CALL	Center for Army Lessons Learned
CAP	combat air patrols
CAS	close air support
CASEVAC	casualty evacuation
CBAT	computer-based ASE training
CBRN	chemical, biological, radiological, and nuclear
CCA	close combat attack
CCIR	commander's critical information requirement
CCM	close combat maneuver
CCP	casualty collection point
CFL	coordinated fire line
CLC	combat logistics convoy
COA	course of action
COMMEX	communications exercise
COMSEC	communications security
CONUS	continental United States
COP	common operational picture
CP	command post
CRP	component repair platoon
CSAR	combat search and rescue
CSM	command sergeant major
CSR	controlled supply rate
CTA	common table of allowance
CTASC	corps/theater automated data processing service center
CTC	combat training center
CTL	commander's task list
CVW	carrier air wing
D3A	decide, detect, deliver, and assess
DA	Department of the Army
DA Pam	Department of the Army pamphlet
DAAS	defense automatic addressing system
DAPP	downed aviator pickup point
DART	downed aircraft recovery team
DEW	directed-energy weapon
DIDEA	detect, identify, decide, engage, and assess
DNBI	disease and nonbattle injury
DOD	Department of Defense
DODAAC	Department of Defense Activity Address Code
DOS	days of supply
DP	decision point

Glossary

DS	direct support
DSN	defense switch network
DST	decision support template
DTC	data transfer cartridge
EA	engagement area
ECOORD	effects coordinator
ELINT	electronic intelligence
EMT	emergency medical treatment
EO	electro-optical
EOD	explosive ordnance disposal
EPA	evasive plan of action
ERFS	extended range fuel system
ESR	external supported recovery
ETA	estimated time of arrival
ETE	estimated time en route
ETL	effective translational lift
EW	electronic warfare
FA	field artillery
FAA	forward assembly area
FAC (A)	forward air controller (airborne)
FAAO	Federal Aviation Administration Order
FARE	forward area refueling equipment
FARP	forward arming and refueling point
FBCB2	Force XXI Battle Command—Brigade and Below
FCR	fire control radar
FID	foreign internal defense
FLIR	forward-looking infrared
FLOT	forward line of own troops
FM	field manual, frequency modulated
FMI	field manual interim
FMT	forward maintenance team
FOB	forward operating base
FOV	field of view
FRAGO	fragmentary order
FS	fire support
FSC	forward support company
FSCL	fire support coordination line
FSCM	fire support coordinating measure
FSE	fire support element
FSO	fire support officer

FST	forward support troop
FW	fixed-wing
GPS	global positioning system
GS	general support
GSR	ground surveillance radar
HA	holding area
HAA	heavy assembly area
HBCT	heavy brigade combat team
HF	high frequency
HHC	headquarters and headquarters company
HHT	headquarters and headquarters troop
HMMWV	high mobility multi-purpose wheeled vehicle
HPT	high-payoff target
HPTL	high-payoff target list
HSC	headquarters and support company
HSS	health support service
HVT	high-value target
IA	interdiction attack
IATF	individual aircrew training folder
IBCT	infantry brigade combat team
IDM	improved data modem
IED	improvised explosive device
IFF	identification friend or foe
IIMC	inadvertent instrument meteorological conditions
ILAP	integrated logistics analysis program
IMDC	isolated, missing, detained, or captured
INTREP	intelligence report
IP	instructor pilot
IPB	intelligence preparation of the battlefield
IR	infrared
ISOPREP	isolated personnel report
ISR	intelligence, surveillance, and reconnaissance
IZLID	infrared zoom laser illuminator designator
JAAT	joint air attack team
JAOC	Joint Force Operations Center
JFACC	joint force air component commander
JFC	Joint Force Commander
JP	joint publication
JPRC	joint personnel recovery center
J-SEAD	joint suppression of enemy air defenses

Glossary

LAN	local area network
LAR	logistics assistant representative
LD	line of departure
LDO	laser designator operator
LNO	liaison officer
LOA	limit of advance
LOC	line of communications
LOGPAC	logistics package
LOGTAADS	Logistics Army Authorization Document System
LOS	line of sight
LP	listening post
LRP	logistics release point
LRU	line replaceable unit
LSA	logistics support area
LST	laser spot trackers
LTL	laser target line
LZ	landing zone
MAC	maintenance allocation chart
MCS	maneuver control system
MDMP	military decisionmaking process
MEDEVAC	medical evacuation
METL	mission essential task list
METT-TC	mission, enemy, terrain and weather, troops and support available, time available, civil considerations
MGRS	military grid reference system
MMC	materiel management center
MOPP	mission-oriented protective posture
MOS	military occupational specialty
MP	maintenance test pilot
MRE	meal, ready to eat
MRLS	multiple launch rocket system
MSR	main supply route
MTOE	modified table of organization and equipment
MTP	mission training plan
NAI	named area of interest
NAVAID	navigational aid
NCO	noncommissioned officer
NCOIC	noncommissioned officer in charge
NEO	noncombatant evacuation operation
NFA	no fire area
NMC	not mission capable

NMP	National Maintenance Program
NOE	nap-of-the-earth
NOTAM	notice to airmen
NSFS	naval surface fire support
NVD	night vision device
NVG	night vision goggles
O&I	operations and intelligence
OAKOC	observation and fields of fire, avenues of approach, key terrain, obstacles and movement, and cover and concealment
OCONUS	outside the continental United States
OH	observation helicopter
OP	observation post
OPCON	operational control
OPLAN	operational plan
OPORD	operating order
OPSEC	operations security
OPTEMPO	operating tempo
OSC	on-scene commander
P4T2	problem, plan, people, parts, time, and tools
PBO	property book officer
PBUSE	property book and unit supply system-enhanced
PC	pilot in command
PCC	precombat check
PCI	precombat inspection
PEO	peace enforcement operation
PFZ	priority fire zone
PIR	priority intelligence report
Pk	probability of kill
PKO	peacekeeping operation
PL	phase line
PLL	prescribed load list
PLS	palletized load system
PMCS	preventive maintenance checks and services
POL	petroleum, oils, and lubricants
PP	passage point
PPC	performance planning card
PPM	progressive phase maintenance
PR	personnel recovery
PRCC	personnel recovery coordination cell
PRO	personnel recovery officer
PSYOPS	psychological operations

Glossary

PZ	pickup zone
QA	quality assurance
QRF	quick reaction force
R&S	reconnaissance and surveillance
REDCON	readiness condition
RESCORT	rescue escort
RETRANS	retransmission
RF	radar frequency
RFA	restricted fire area
RMB	rescue mission brief
RMC	rescue mission commander
ROE	rules of engagement
ROI	rules of instruction
ROZ	restricted operating zone
RP	release point
RSR	required supply rate
RTD	return to duty
RTF	return to force
RTO	radio telephone operator
RX	reparable exchange
S-1	personnel staff officer
S-2	intelligence staff officer
S-3	operations staff officer
S-4	logistics staff officer
S-6	command, control, communications, and computer operations (C4 Ops) officer
SA	situational awareness
SAMS	standard Army maintenance system
SAMS-1	standard Army maintenance system-level 1
SAMS-2	standard Army maintenance system-level 2
SAMS-E	standard Army maintenance system-enhanced
SAR	search and rescue
SARIR	search and rescue incident report
SARSS	standard Army retail supply system
SARSS-1	standard Army retail supply system-level 1
SARSS-2	standard Army retail supply system-level 2
SARSS-Gateway	standard Army retail supply system-gateway
SATCOM	satellite communication
SBCT	Stryker brigade combat team
SBF	support by fire
SCAR	security clearance access roster

SEAD	suppression of enemy air defense
SECM	shop equipment contact maintenance
SINCGARS	single-channel ground and airborne radio system
SITREP	situation report
SKO	sets, kits, and outfits
SKOT	sets, kits, outfits, and special tools
SM	Soldier's manual
SO	safety officer
SOI	signal operation instructions
SOP	standing operating procedure
SP	standardization instructor pilot
SPINS	special instructions
SPOTREP	spot report
SSA	supply support activity
SSM	surface-to-surface missile
STAMIS	standard army management information system
STP	Soldier training publication
STX	situational training exercise
SU	situational understanding
SWT	scout weapons team
TA	target acquisition
TAC CP	tactical command post
TACFIRE	tactical fire direction system
TACON	tactical control
TACOPS	tactical operations
TACSOP	tactical standing operating procedure
TB	technical bulletin
TC	training circular
TCF	tactical combat force
TCP	traffic control point
TDH	time, distance, and heading
TF	task force
TG	trainer's guide
TLP	troop leading procedures
TM	technical manual
TOC	tactical operations center
TOC NCOIC	tactical operations center noncommissioned officer in charge
TOE	table of organization and equipment
TOT	time on target
TRP	target reference point

Glossary

TTP	tactics, techniques, and procedures
TTT	time to target
UAS	unmanned aerial system
UBL	unit basic load
UH	utility helicopter
UHF	ultra high frequency
UIC	unit identification code
ULLS	unit-level logistics system
ULLS-A	unit-level logistics system-aviation
ULLS-S4	unit-level logistics system-logistics staff officer
UMT	unit ministry team
USAAWC	United States Army Aviation Warfighting Center
USASC	United States Army Safety Center
VBIED	vehicle-borne improvised explosive device
VHF	very high frequency
WARNO	warning order
WFF	warfighting function
XO	executive officer

References

The bibliography lists FMs by new number followed by old number. These publications are sources for additional information on the topics in this FM. Most JPs can be found at <http://www.dtic.mil/doctrine/jel/>. Most Army doctrinal publications are available online at <http://155.217.58.58/atdls.html>. FAA Orders can be found at <http://www.faa.gov/ATpubs/>.

SOURCES USED

These are the sources quoted or paraphrased in this publication.

ARMY PUBLICATION

AR 95-1. *Flight Regulations*. 3 February 2006.

AR 700-138. *Army Logistics Readiness and Sustainability*. 26 February 2004.

COMMON TABLE OF ALLOWANCES

CTA 8-100. *Army Medical Department Expendable/Durable Items*. 17 December 2004.

CTA 50-900. *Clothing and Individual Equipment*. 2 October 2006.

CTA 50-909. *Field and Garrison Furnishings and Equipment*. 26 September 2006.

FIELD MANUALS

FM 1 (FM 100-1). *The Army*. 14 June 2005.

FM 1-100. *Army Aviation Operations*. 21 February 1997.

FM 1-120. *Army Air Traffic Services Contingency and Combat Zone Operations*. 22 May 1995.

FM 3-0 (FM 100-5). *Operations*. 14 June 2001.

FM 3-04.111. *Aviation Brigades*. 21 August 2003.

FM 3-04.140. *Helicopter Gunnery*. 14 July 2003.

FM 3-04.500. *Army Aviation Maintenance*. 23 August 2006.

FM 3-04.513 (FM 1-513). *Battlefield Recovery and Evacuation of Aircraft*. 27 September 2000.

FM 3-06. *Urban Operation*. 1 June 2003.

FM 3-06.1 (FM 1-130). *Aviation Urban Operations Multiservice Procedures for Aviation Urban Operations*. 9 July 2005.

FM 3-06.11 (FM 90-10-1). *Combined Arms Operations in Urban Terrain*. 28 February 2002.

FM 3-09.32 (FM 90-20). *Multiservice Procedures for the Joint Application of Firepower*. 29 October 2004.

FM 3-20.96. *Cavalry Squadron (RSTA)*. 20 September 2006.

FM 3-50.1. *Army Personnel Recovery*. 10 August 2005.

FM 3-90. *Tactics*. 4 July 2001.

FM 4-0 (FM 100-10). *Combat Service Support*. 29 August 2003.

FM 4-30.31. *Recovery and Battlefield Damage Assessment and Repair*. 19 September 2006.

FM 5-0 (FM 101-5). *Army Planning and Orders Production*. 20 January 2005.

FM 6-0. *Mission Command: Command and Control of Army Forces*. 11 August 2003.

FM 7-1. *Battle Focused Training*. 15 September 2003.

FM 10-1. *Quartermaster Principles*. 11 August 1994.

FM 17-95. *Cavalry Operations*. 24 December 1996.

References

- FM 34-130. *Intelligence Preparation of the Battlefield*. 8 July 1994.
FM 90-21. *(JAAT) Multiservice Procedures for Joint Air Attack Team Operations*. 3 June 1998.
FM 101-5-2. *U.S. Army Report and Message Formats*. 29 June 1999.

FIELD MANUAL INTERIMS

- FMI 4-90.1. *Heavy Brigade Combat Team Logistics*. 15 March 2005.
FMI 5-0.1. *The Operations Process*. 31 March 2006.

JOINT PUBLICATIONS

- JP 1-02. *Department of Defense Dictionary of Military and Associated Terms*. 14 April 2006.
JP 3-09.3. *Joint Tactics, Techniques, and Procedures for Close Air Support (CAS)*. 3 September 2003.
JP 3-09.1. *Joint Tactics, Techniques, and Procedures for Laser Designation Procedures (JLASER)*. 28 May 1999.
JP 3-30. *Command and Control for Joint Air Operations*. 5 June 2003.
JP 3-52. *Joint Doctrine Airspace Control in a Combat Zone*. 30 August 2004.
JP 3-60. *Joint Doctrine for Targeting*. 17 January 2002.
JP 4-0. *Doctrine for Logistic Support of Joint Operations*. 6 April 2000.
JP 4-03. *Joint Bulk Petroleum and Water Doctrine*. 23 May 2003.

TRAINING CIRCULARS

- TC 1-400. *Brigade Aviation Element Handbook*. 27 April 2006.
TC 1-201. *Tactical Flight Procedures*. 20 January 1984.
TC 1-210. *Aircrew Training Program Commander's Guide to Individual, Crew, and Collective Training*. 20 June 2006.

TECHNICAL MANUALS

- TM 1-1520-248-10. *Operator's Manual for Army OH-58D Helicopter*. 15 March 2005.
TM 750-244-1-5. *Procedures for the Destruction of Aircraft and Associated Equipment to Prevent Enemy Use*. 12 November 1971.

DOCUMENTS NEEDED

These documents must be available to the intended users of this publication.

DEPARTMENT OF THE ARMY FORMS

- DA Form 1594. *Daily Staff Journal or Duty Officer's Log*.
DA Form 2028. *Recommended Changes to Publications and Blank Forms*.
DA Form 5484. *Mission Schedule/Brief*.
DA Form 7573. *Aircraft Survivability Equipment (ASE) Risk Assessment Worksheet Survivability Risk Analysis*.

DEPARTMENT OF DEFENSE FORMS

- DD Form 1972. *Joint Tactical Air Strike Request*.
DD Form 1833. *Isolated Personnel Report*.

READINGS RECOMMENDED

These sources contain relevant supplemental information.

- Aviation Liaison Officer Handbook*, United States Army Aviation Center. July 2001.
- AR 200-1. *Environmental Protection and Enhancement*. 21 February 1997.
- AR 385-40. *Accident Reporting and Records*. 1 November 1994.
- AR 385-64. *U.S. Army Explosives Safety Program*. 1 February 2000.
- AR 385-95. *Army Aviation Accident Prevention*. 10 December 1999.
- AR 600-55. *The Army Driver and Operator Standardization Program (Selection, Training, Testing, and Licensing)*. 31 December 1993.
- AR 710-2. *Supply Policy Below the National Level*. 8 July 2005.
- ARTEP 1-111-MTP. *Mission Training Plan for the Aviation Brigades*. 27 October 2005.
- ARTEP 1-113-MTP. *Mission Training Plan for the Assault Helicopter Battalion*. 29 December 2005.
- ARTEP 1-118-MTP. *General Support Aviation Battalion*. 17 January 2006.
- ARTEP 1-126-MTP. *Mission Training Plan for the Attack Reconnaissance Helicopter Battalion/Squadron*. 8 March 2006.
- ARTEP 1-245-MTP. *Mission Training Plan for the Heavy Lift Helicopter Battalion*. 31 August 2001.
- ARTEP 1-425-MTP. *Mission Training Plan for the Air Traffic Services Battalion*. 19 December 2002.
- ARTEP 1-500-MTP. *Aviation Intermediate Maintenance (AVIM) Battalion and Company*. 1 April 2002.
- DA Pam 25-30. *Consolidated Index of Army Publications and Blank Forms*.
- DA Pam 25-33. *User's Guide for Army Publications and Forms*.
- DA Pam 385-40. *Army Accident Investigation and Reporting*.
- DA Pam 385-64. *Ammunition and Explosives Safety Standards*.
- DA Pam 710-2-1. *Using Unit Supply System (Manual Procedures)*.
- DA Pam 710-2-2. *Supply Support Activity Supply System: Manual Procedures*.
- DODD 2000.12. *DOD Antiterrorism (AT) Program*. 18 August 2003.
- EM 0007. *FEDLOG*. 1 October 2006. (S&I, Commander, USAMC Logistics Support Activity, ATTN: AMXLS-MLA, (A. LEWIS) Bldg 5307, Redstone Arsenal, Al 35898-7466.)
- EM 0126. TM 1-1520-Longbow/Apache. *Interactive Electronic Technical Manual for Longbow/Apache*. 27 December 2005.
- EM 0253. TM 1-1520-248-S. *Interactive Electronic Technical Manual for Preparation for Shipment of Army Model OH-58D Helicopter*. 30 June 2004.
- FAAO 3120.4L. *Air Traffic Technical Training*. 22 June 2005.
- FAAO 7000.5C. *Submissions for Air Traffic Publications*. 18 October 2001.
- FAAO 7010.1S. *Air Traffic Control Safety and Audits*. 1 October 2005.
- FAAO 7110.10S. *Flight Services*. 3 August 2006.
- FAAO 7110.65R. *Air Traffic Control*. 3 August 2006.
- FAAO 7210.3U. *Facility Operation and Administration*. 3 August 2006.
- FAAO 7210.56C. *Air Traffic Quality Assurance*. 15 August 2002.
- FAAO 7340.1Y. *Contractions*. 3 August 2006.
- FAAO 7350.7X. *Location Identifiers*. 3 August 2006.
- FAAO 7400.2F. *Procedures for Handling Airspace Matters*. 3 August 2006.
- FAAO 7450.1. *Special Use Airspace Management System*. 21 June 1999.

References

- FAAO 7610.4K. *Special Military Operations*. 5 August 2004.
- FAAO 7900.5B. *Surface Weather Observing*. 11 May 2001.
- FAAO 7930.2. *Notices to Airmen (NOTAMs)*. 16 February 2006.
- FM 1-02. *Operational Terms and Graphics*. 21 September 2004.
- FM 1-113. *Utility and Cargo Helicopter Operations*. 12 September 1997.
- FM 1-564. *Shipboard Operations*. 29 June 1997.
- FM 2-0 (FM 34-1). *Intelligence and Electronic Warfare Operations*. 27 February 1994.
- FM 3-01.4. *J-SEAD, Multiservice Tactics, Techniques, and Procedures (MTTP) for Joint Suppression of Enemy Air Defenses (U)*. 28 May 2004.
- FM 3-04.104. *Tactics, Techniques, and Procedures for Forward Arming and Refueling Point*. 3 August 2006.
- FM 3-04.300. *Flight Operations Procedures*. 26 April 2004.
- FM 3-04.301. *Aeromedical Training for Flight Personnel*. 29 September 2000.
- FM 3-04.303. *Air Traffic Services Facility Operations, Training, Maintenance, and Standardization*. 3 December 2003.
- FM 3-04.508 (FM 1-508). *Maintaining Aviation Life Support System Maintenance Management and Training Programs*. 23 April 2004.
- FM 3-05.30 (FM 33-1). *Psychological Operations*. 15 April 2005.
- FM 3-05.60 (FM 1-108). *Army Special Operations Forces Aviation Operations*. 16 October 2000.
- FM 3-07 (FM 100-23). *Stability Operations and Support Operations*. 20 February 2003.
- FM 3-07.31. *Peace Operations Multiservice Tactics, Techniques, and Procedures for Conducting Peace Operations*. 26 October 2003.
- FM 3-13. *Information Operations: Doctrine, Tactics, Techniques, and Procedures*. 28 November 2003.
- FM 3-19.1 (FM 19-1). *Military Police Operations*. 22 March 2001.
- FM 3-21.38. *Pathfinder Operations*. 25 April 2006.
- FM 3-35.4. *Deployment Fort-to-Port*. 19 June 2002.
- FM 3-50.3. *Multi-Service Procedures for Survival, Evasion and Recovery*. 19 March 2003.
- FM 3-52 (FM 100-103). *Army Airspace Command and Control in a Combat Zone*. 1 August 2002.
- FM 3-52.2 (FM 100-103-2). *Multi-Service Procedures for the Theater Air-Ground System*. 8 December 2003.
- FM 3-90.1 (FM 71-1). *Tank and Mechanized Infantry Company Team*. 9 December 2002.
- FM 3-90.6. *The Brigade Combat Team*. 4 August 2006.
- FM 3-90-96. *Cavalry Squadron (RSTA)*. 20 September 2006.
- FM 3-100.4. *Environmental Considerations in Military Operations*. 15 June 2000.
- FM 3-100.12. *Risk Management Multiservice Tactics, Techniques, and Procedures for Risk Management*. 15 February 2001.
- FM 4-01.011 (FM 55-65). *Unit Movement Operations*. 31 October 2002.
- FM 4-01.45. *Multi-Service Tactics, Techniques, and Procedures for Convoy Operations*. 24 March 2005.
- FM 4-20.197 (FM 10-450-3). *Multiservice Helicopter Sling Load: Basic Operations and Equipment*. 20 July 2006.
- FM 5-34. *Engineer Field Data*. 19 July 2005.
- FM 5-103. *Survivability*. 10 June 1985.
- FM 6-20. *Fire Support in the AirLand Battle*. 17 May 1988.

- FM 6-20-40. *Tactics, Techniques, and Procedures for Fire Support For Brigade Operations (Heavy)*. 5 January 1990.
- FM 6-20-50. *Tactics, Techniques, and Procedures for Fire Support for Brigade Operations (Light)*. 5 January 1990.
- FM 7-0. *Training the Force*. 22 October 2002.
- FM 7-15. *The Army Universal Task List*. 31 August 2003.
- FM 7-20. *The Infantry Battalion*. 6 April 1992.
- FM 8-10-26. *Employment of the Medical Company (Air Ambulance)*. 16 February 1999.
- FM 10-67-1. *Concepts and Equipment of Petroleum Operations*. 2 April 1998.
- FM 20-3. *Camouflage, Concealment, and Decoys*. 30 August 1999.
- FM 34-2-1. *Tactics, Techniques, and Procedures for Reconnaissance and Surveillance and Intelligence Support to Counterreconnaissance*. 19 Jun 91.
- FM 34-60. *Counterintelligence*. 3 October 1995.
- FM 55-30. *Army Motor Transport Units and Operations*. 15 September 1999.
- FM 55-450-2. *Army Helicopter Internal Load Operations*. 5 June 1992.
- FM 71-100. *Division Operations*. 28 August 1996.
- FM 71-100-2. *Infantry Division Operations, Tactics, Techniques, and Procedures*. 31 August 1993.
- FM 71-100-3. *Air Assault Division Operations Tactics, Techniques, And Procedures*. 29 October 1996.
- FM 90-4. *Air Assault Operations*. 16 March 1987.
- FM 100-8. *The Army in Multinational Operations*. 24 November 1997.
- FM 100-9. *Reconstitution*. 13 January 1992.
- FM 100-13. *Battlefield Coordination Detachment. (BCD)*. 5 September 1996.
- FM 100-14. *Risk Management. Change I*. 8 August 2005.
- FM 100-15. *Corps Operations*. 29 October 1996.
- FM 100-17-3. *Reception, Staging, Onward Movement, and Integration*. 17 March 1999.
- FM 100-17-5. *Redeployment*. 29 September 1999.
- FMI 3-04.155. *Army Unmanned Aircraft System Operations*. 4 April 2006.
- GTA 05-08-001. *Survivability Positions*. 1 August 1993.
- JP 3-0. *Joint Operations*. 17 September 2006.
- JP 3-01.4. *JTTP for Joint Suppression of Enemy Air Defenses (J-SEAD)*. 25 July 1995.
- JP 3-09. *Doctrine for Joint Fire Support*. 12 May 1998.
- JP 3-50.2. *Doctrine for Joint Combat Search and Rescue*. 26 January 1996.
- JP 3-50.21. *Joint Tactics, Techniques and Procedures for Combat Search and Rescue*. 23 March 1998.
- SDDCTEA Pamphlet 55-19. *Tie-down Handbook for Rail Movements*. September 2003. (Surface Deployment and Distribution Command Transportation Engineering Agency Fort Eustis, Virginia).
- SDDCTEA Pamphlet 55-20. *Tie-down Handbook for Truck Movements*. July 2001. (Surface Deployment and Distribution Command Transportation Engineering Agency Fort Eustis, Virginia).
- SDDCTEA Pamphlet 55-21. *Lifting and Tiedown Handbook for U.S. Military Helicopters*. June 2006. (Surface Deployment and Distribution Command Transportation Engineering Agency Fort Eustis, Virginia).
- SDDCTEA Pamphlet 55-22. *Lashing Handboo for Marine Movements*. August 2005. (Surface Deployment and Distribution Command Transportation Engineering Agency Fort Eustis, Virginia).

References

- SDDCTEA Pamphlet 55-23. *Tiedown Handbook for Containerized Movements*. September 2003. (Surface Deployment and Distribution Command Transportation Engineering Agency Fort Eustis, Virginia).
- SDDCTEA Pamphlet 55-24. *Vehicle Preparation Handbook for Fixed Wing Air Movements*. 2002. (Surface Deployment and Distribution Command Transportation Engineering Agency Fort Eustis, Virginia).
- SDDCTEA Pamphlet 70-1. *Transportability for Better Deployability*. 2003. (Surface Deployment and Distribution Command Transportation Engineering Agency Fort Eustis, Virginia).
- SDDCTEA Pamphlet 700-2. *Logistics Handbook for Strategic Mobility Planning*. 2002. (Surface Deployment and Distribution Command Transportation Engineering Agency Fort Eustis, Virginia).
- SDDCTEA Pamphlet 700-4. *Vessel Characteristics for Shiploading*. 2001. (Surface Deployment and Distribution Command Transportation Engineering Agency Fort Eustis, Virginia).
- SDDCTEA Pamphlet 700-5. *Deployment Planning Guide*. 2001. (Surface Deployment and Distribution Command Transportation Engineering Agency Fort Eustis, Virginia).
- SDDCTEA Pamphlet 700-6. *Large, Medium-Speed Roll-on/Roll-off (RORO) (LMSR) Users' Manual*. 2002. (Surface Deployment and Distribution Command Transportation Engineering Agency Fort Eustis, Virginia).
- STP 1-15D13-SM-TG. *Soldier's Manual and Trainer's Guide for MOS 15D, Aircraft Powertrain Repairer, Skill Levels 1 and 3*. 27 October 2004.
- STP 1-15M13-SM-TG. *Soldier's Manual and Trainer's Guide for MOS 15M, UH-1 Helicopter Repairer, Skill Levels 1, 2, and 3*. 26 October 2004.
- STP 1-15T13-SM-TG. *Soldier's Manual and Trainer's Guide, MOS 15T, UH-60 Helicopter Repairer, Skill Levels 1, 2, and 3*. 6 January 2005.
- STP 1-15U13-SM-TG. *Soldier's Manual and Trainer's Guide for MOS 15U, CH-47D Helicopter Repairer, Skill Levels 1, 2, and 3*. 29 October 2004.
- STP 1-93C1-SM-TG. *Soldier's Manual and Trainer's Guide, MOS 93C, Air Traffic Control, Skill Level 1*. 1 March 2002.
- STP 1-93C24-SM-TG. *Soldier's Manual and Trainer's Guide, MOS 93C, Air Traffic Control, Skill Levels 2/3/4*. 4 June 2002.
- STP 1-93P1-SM-TG. *Soldier's Manual and Trainer's Guide, MOS 93P, Aviation Operations Specialist, Skill Level 1*. 1 October 2002.
- STP 1-93P24-SM-TG. *Soldier's Manual and Trainer's Guide, MOS 93P, Aviation Operations Specialist, Skill Levels 2/3/4*. 1 October 2002.
- TC 1-218. *Aircrew Training Manual Utility Airplane C-12*. 13 September 2005.
- TC 1-219. *Aircrew Training Manual, Guardrail Common Sensor Airplane RC-12*. 3 June 2002.
- TC 1-228. *Aircrew Training Manual, OH 58-A, Kiowa Helicopter*. 13 June 2006.
- TC 1-237. *Aircrew Training Manual, Utility Helicopter, H-60 Series*. 27 September 2005.
- TC 1-238. *Aircrew Training Manual, Attack Helicopter, AH-64A*. 23 September 2005.
- TC 1-240. *Aircrew Training Manual Cargo Helicopter, CH-47D*. 12 September 2005.
- TC 1-248. *Aircrew Training Manual, OH-58D, Kiowa Warrior*. 12 September 2005.
- TC 1-251. *Aircrew Training Manual Attack Helicopter AH-64D*. 14 September 2005.
- TC 1-600. *Unmanned Aircraft Systems Commander's Guide and Aircrew Training Manual*. 23 June 2006.
- TM 1-1500-204-23-1. *Aviation Unit Maintenance (AVUM) and Aviation Intermediate Maintenance (AVIM) Manual for General Aircraft Maintenance (General Maintenance and Practices) Volume 1*. 31 July 1992.

- TM 1-1520-237-S. *Preparation for Shipment of Army Models, UH-60A, UH-60L, EH-60A, UH-60Q and HH-60L Helicopters*. 17 April 2006.
- TM 1-1520-252-S. *Preparation for Shipment of MH-47E Helicopter*. 28 June 1995.
- TM 55-1520-238-S. *Preparation for Shipment Army AH-64A Helicopter*. 30 September 1990.
- TM 55-1520-241-S. *Preparation for Shipment of CH-47 Helicopter*. 1 March 1979.
- TM 55-1560-307-13&P. *Operator, Aviation Unit and Aviation Intermediate Maintenance Manual With Repair Parts and Special Tools List for Extended Range Fuel System Army Model CH-47 Helicopter*. 11 December 1990.
- Unit Movement Officer (UMO) Deployment Handbook Reference 97-1*, U.S. Army Transportation School, Fort Eustis, VA.
- USASC. *Commander and Staff Risk Management Booklet*. 6 January 1999.
- USASC. *Small Unit Risk Management Booklet*. 6 January 1999.

Index

A

- action on contact, 1-4, 1-5, 2-19, 2-22, 2-35, 2-36, 3-2, 3-12, 3-17, 3-20, 3-31, 3-39, 3-49, 3-51, 3-58, 3-59, 3-82, 3-86, A-6
- action on the objective, 2-36
- administrative and logistics (A&L), 2-3, 2-4, 2-13
- advanced party (ADVON), 3-96
- aerial observation, 3-10
- aerial reconnaissance, C-8
- aerial vehicle (AV), C-17
- after-action review (AAR), 2-40
- AH-64A, C-1
- air assault, 1-3, 1-4, 3-28, 3-30, 3-50, 3-52, 3-53, 3-54, 3-86, 3-91, 3-110, 3-111, 3-116, 3-121, B-4
- air assault task force, 2-26
- air control order (ACO), 2-22, 2-32, 2-33
- air defense (AD), C-3, C-4, C-5, C-6
- air defense artillery (ADA), C-6, C-13
- air interdiction, 2-24
- air liaison officer (ALO), 2-5, 2-15, B-10, C-7
- air mission commander (AMC), 2-27, 2-28, 2-31, 2-33, 2-39, 3-2, 3-3, 3-10, 3-50, 3-58, 3-62, 3-64, 3-80, 3-89, 3-90, 3-91, 3-94, 4-6, B-2, B-3, C-11, C-13, D-6, D-16
- air movement, 1-3, 1-3, 2-19, 3-28, 3-50, 3-52, 3-53, 3-95
- air route, 3-21, 3-23
- air support, C-3, C-7
 - operations center, C-3
- air tasking order (ATO), 2-9, 2-22, 3-89, 3-97, C-4, C-7
- air traffic services (ATS), 2-10, 4-14
- airborne warning and control system, 3-120
- airborne warning and control system (AWACS), C-4
- aircraft maintenance platoon, 1-9, 1-11
- aircraft survivability equipment (ASE), 2-10, 2-22, 2-28, 2-29, 2-32, 2-33, 2-37, 3-33, 3-99, 3-120, A-1, A-2, A-4, A-6, A-7, A-8, A-9
- aircraft survivability equipment trainer (ASET), A-8, A-9
- aircrew training manual (ATM), 2-35, 3-69, A-8
- aircrew training program (ATP), 2-28, 2-29, A-8
- airframe repair platoon (ARP), 1-11, 4-12, 4-13
- air-ground integration, 3-3
- airspace, 1-6, 2-10, 2-17, 3-8, 3-91, 3-97, 3-99, 3-111, 4-10, B-10, D-5
- airspace coordinating measure (ACM), 2-11, C-8, C-10, C-11, C-16
- airspace coordination area (ACA), C-8, C-10
- airspace management, 2-10
- airspace workstation, 2-2
- ambush, 3-22, 3-42, 3-48, 3-49, 3-111
- ammunition transfer holding point (ATHP), 4-19
- area of operations (AO), C-1, C-2, C-4, C-17
- armament maintenance officer, 2-30
- armor, 2-13, 2-14, 4-16
- Army airspace command and control (A2C2), 1-6, 1-9, 2-4, 2-9, 2-10, 2-11, 2-35, 3-119, B-2, B-3, C-5
- Army battle command system (ABCS), 2-2
- Army Tactical Command and Control System (ATCCS), 2-2, 2-9
- Army tactical missile system (ATACMS), C-16
- Army warfighting function, 1-2, 2-16
- assault helicopter troop (AHT), 1-5, 1-9, 1-11
- assembly area (AA), 1-4, 2-6, 2-8, 2-19, 2-20, 2-22, 2-29, 2-32, 2-36, 3-21, 3-27, 3-55, 3-82, 3-114, 3-116, 3-117, 3-119
- assigned, C-1, C-5, C-8
- Assistant Chief of Staff, Operations and Plans (G3), C-5, C-7
- attached, C-2
- attack by fire (ABF), 2-33, 2-34, 3-7, 3-19, 3-21, 3-59, 3-64, 3-82, 3-84, 3-85, 3-86, 3-94, 3-110, 3-117, 3-119, 4-23, A-4, B-3, C-6
- attack guidance, 2-24, 3-12
- attack guidance matrix, 2-24
- attack operation, 1-3, 3-85, 3-86
- authorized stock level (ASL), 4-5, 4-19
- avenue of approach, 3-14, 3-25, 3-26, 3-27, 3-33, 3-35, 3-36, 3-41, 3-42, 3-45, 3-52, 3-54, 3-74, 3-75, 3-76, 3-94, 3-110
- avenues of approach, C-3
- aviation battalion task force (ABTF), 2-23, 2-26, 3-1, B-2
- aviation life support equipment (ALSE), 2-30, 3-113, 4-25
- aviation life support officer (ALSO), 2-30
- aviation life support system (ALSS), 2-30, 4-25
- aviation maintenance company, 1-5, 1-9, 2-12, 4-1, 4-2, 4-6, 4-7, 4-9, 4-12, 4-13, 4-17, 4-19, 4-20, 4-24
- aviation maintenance troop, 1-9, 1-11

aviation materiel officer (AMO), 2-12

aviation mission planning system (AMPS), 2-2, 2-10, 2-29, 2-32, 2-33, 2-34, 2-35, 3-7, 3-38, 3-112, A-4, A-6, B-9

aviation support battalion (ASB), 1-5, 1-9, 2-12, 2-13, 4-1, 4-2, 4-3, 4-4, 4-5, 4-7, 4-9, 4-13, 4-14, 4-15, 4-16, 4-17, 4-18, 4-19, 4-20, 4-21, 4-23

aviation support company (ASC), 4-1, 4-5, 4-6, 4-7, 4-12, 4-17, 4-19, 4-20, 4-22, 4-24

aviation support troop, 1-9, 1-11

axis of advance, 3-39, 3-41, 3-42, 3-43, 3-44

B

backbrief, 2-35

basic combat maneuver (BCM), 3-2

basic combat maneuvers, 3-51

basic load, 2-21, 4-4

battalion aid station (BAS), 4-17

battalion support area (BSA), 4-3, 4-14

battle captain, 2-15

battle command, 1-9, 2-13, 4-5

battle damage assessment (BDA), 2-8, 2-24, 2-25, 2-37, 2-39, 3-61, 3-62, 3-63, 3-83, 3-119, C-7

battle damage assessment and repair (BDAR), 4-9

battle damage assessment repair (BDAR), 4-9, 4-12, 4-13, 4-16, 4-17

battle drill, 2-2, 2-35, 2-40, 3-12, 3-58, 3-63, 3-89, B-8

battle handover (BHO), 2-39, 3-3, 3-19, 3-25, 3-38, 3-56, 3-58, 3-86, 3-118, 3-119

battle handover line, 3-117

battle position (BP), 2-36, 3-7, 3-21, 3-37, 3-41, 3-42, 3-43, 3-44, 3-64, 3-74, 3-75, 3-77, 3-78, 3-82, 3-83, 3-84, 3-85,

3-86, 3-110, 3-119, B-2, B-3, C-5, C-6, C-12

battle rhythm, 2-9, 3-13, 3-19

battle update briefing (BUB), 2-18

battlefield geometry, 3-16

boundaries, 2-1, 3-23, 3-24, 3-25, 3-26, 3-27, 3-28, 3-99

bounding overwatch, 3-6, 3-9, 3-10, 3-36

brigade aviation element (BAE), 2-2, 2-10, B-2, B-10

brigade combat team (BCT), 2-10, C-5

brigade support battalion, 1-10

bump plan, 2-22, 2-38

bypass, 1-4, 3-2, 3-11, 3-12, 3-13, 3-16, 3-19, 3-22, 3-23, 3-26, 3-27, 3-42, 3-48, 3-53, 3-63, 3-82, 4-2

C

call for fire, 2-37, 3-2

casualty collection point (CCP), 2-21

casualty evacuation (CASEVAC), 1-5, 2-36, 2-37, 3-50, 3-111

center of gravity, 3-15

chaplain, 2-8, 4-16

checklist, 2-11, 2-31, 2-35, B-7, D-1

checkpoint, 2-19, 3-22, 3-23, 3-26, 3-91, 3-99, 3-100, 3-118

chemical officer, 2-11

chemical, biological, radiological, and nuclear (CBRN), 1-6, 1-9, 2-11, 2-12, 2-14, 2-18, 2-20, 2-21, 3-24, 3-25, 3-119, 4-16, D-3, D-4, D-14, D-15

chemical, biological, radiological, and nuclear (CBRN), 1-6

civil affairs (CA), 2-24, 3-13

civil support, 1-2, 3-1, 3-14, 3-95, 3-96, 3-97, 3-98, 4-23

civil-military operations officer (S9), 2-15

class of supply, 2-12

clearance of fire, 2-37

close air support (CAS), 2-10, 2-17, 2-24, 2-29, 3-3, 3-19, 3-54, 3-58, 3-59, 3-63, 3-64, 3-75, 3-78, 3-88, 3-109, B-3, B-4, B-10, C-2, C-4, C-11, C-12, C-19

close combat, 1-4, 3-11, 3-19

close combat attack (CCA), 1-3, 1-4, 3-3, 3-40, 3-42, 3-48, 3-52, 3-53, 3-54, 3-59, 3-60, 3-61, 3-62, 3-63, 3-110, 3-111, 3-116

close combat maneuver (CCM), 3-119

cloverleaf, 3-62

collective task, 2-28, 2-40

combat air patrol (CAP), C-4

combat aviation brigade (CAB), 1-5, 1-6, 2-2, 2-34, 3-114, 4-1, 4-3, 4-6, 4-7, 4-9, 4-17, 4-19, B-10

combat cruise, 3-4, 3-5

combat cruise left and right, 3-4

combat load, 4-4

combat logistics patrol (CLP), 4-2

combat search and rescue (CSAR), 3-87, 3-89

combat spread, 3-4, 3-6, 3-51

combat training center (CTC), A-8

command and control (C2), xi, 1-2, 1-5, 1-6, 2-1, 2-2, 2-3, 2-5, 2-14, 2-15, 2-16, 2-17, 2-18, 2-19, 2-20, 2-22, 3-2, 3-14, 3-31, 3-36, 3-47, 3-49, 3-50, 3-61, 3-63, 3-82, 3-83, 3-89, 3-90, 3-94, 3-95, 3-97, 3-100, 3-118, 4-2, 4-10, 4-14, 4-16, B-4, C-3, C-4, C-7, C-13

system, C-3

command group, 1-6, 2-5, 3-13, 4-16

command net, 2-3

command post (CP), 1-6, 1-9, 2-3, 2-4, 2-5, 2-12, 2-13, 2-14, 2-15, 2-16, 2-17, 2-18, 2-19, 2-20, 2-21, 2-26, 2-27, 4-16, B-9, D-11

command relationships assigned, C-1, C-5, C-8 attached, C-2

- operational control (OPCON), C-8
tactical control (TACON), C-1, C-8
- command sergeant major (CSM), 2-6, 2-18, D-2, D-16
- commander, C-1, C-2, C-3, C-4, C-5, C-7, C-8, C-13
air mission (AMC), C-11, C-13
joint force (JFC), C-1, C-8
joint force air component (JFACC), C-8
mission (MC), C-1, C-2, C-3, C-4, C-5, C-8, C-10, C-14, C-17, C-19
- commander's critical intelligence requirement (CCIR), 2-7
- commander's task list (CTL), 2-28
- commander's critical intelligence requirement (CCIR), 2-7, 2-15, 3-13, 3-14, 3-19
- commander's task list (CTL), 2-28, 2-29, 3-115
- common operating picture (COP), 2-14, 3-31
- common operational picture (COP), 1-4
- communication card, 2-34, 2-35
- communications, C-2, C-3, C-4, C-7, C-12, C-19
- communications exercise (COMMEX), 2-37
- communications security (COMSEC), 2-3, 2-12, 2-32, 2-37, 2-38, 4-16, D-19
- communications/automation, 4-16
- component repair platoon (CRP), 1-9, 1-11, 4-12, 4-13, 4-19, 4-20
- computer-based ASE training (CBAT), 2-28, A-8, A-9
- contact point, 3-23, 3-26, 3-116, 3-117
- continuous attack, 3-64
- contour, 3-6, 3-8, 3-9, 3-10
- control measure, 2-9, 2-19, 2-32, 3-18, 3-19, 3-23, 3-26, 3-27, 3-33, 3-38, 3-49, 3-61, 3-73, 3-76, 3-78, 3-80, 3-116, 3-117, 3-118, 3-119, B-2, B-8, B-9, D-3
- control point, 3-91
- controlled supply rate (CSR), 4-4
- convoy, 1-2, 1-3, 2-19, 2-20, 3-48, 3-49, 3-50, 3-97, 4-15, D-2, D-3, D-11
- convoy security, 1-3, 3-31, 3-46, 3-48, 3-49, 4-15
- coordinated fire line (CFL), 3-16
- coordinating staff, 1-7, 2-7
- coordination point, 3-26
- cordon and search, 3-45
- corridor, 2-29, 2-32, 3-21, 3-72, 3-103, B-2
- counter-drug operation, 3-96
- countermeasure, 2-3, 2-29, A-2, A-6, A-9, C-20
- countersurveillance, 2-3
- course of action (COA), C-3, C-6
- cover operation, 1-5, 3-34, 3-44
- crew chief, 2-28
- crew mission brief, 2-35
- crew rest, 3-13, 3-50
- crew-served weapon (CSW), 2-20, D-2
- ### D
- data transfer cartridge, 2-34, 2-38
- day of supply (DOS), 4-4, 4-13, 4-18, 4-20
- debrief, 2-38, 2-39, 2-40, 3-116
- deception, 2-24, 3-93, 3-120
- decide, detect, deliver, and assess (D3A), 2-23
- decision point (DP), 2-19, 3-72, 4-14
- decisive point (DP), C-3
- decontamination, 2-11, 2-14, 4-16, 4-18
- defend, 3-42, 3-44, 4-6, 4-19
- defense automatic addressing system (DAAS), 4-23, 4-24
- Defense Finance and Accounting Service, 4-24
- defensive operation, 2-17
- defensive operations, C-1
- deferred maintenance, 2-27, 4-9
- delay, 1-2, 2-25, 3-32, 3-33, 3-42, 3-44, 3-63, 4-8, A-6
- demonstration, 1-3, 3-120, 3-121
- Department of Defense (DOD), 3-87
- direct fire, 2-8, 3-2, 3-12, 3-13, 3-18, 3-20, 3-23, 3-32, 3-37, 3-40, 3-41, 3-42, 3-59, 3-63, 3-71, 3-73, 3-74, 3-75, 3-76, 3-77, 3-80, 3-82, 3-83, 3-87, 3-99, B-5
- direct support (DS), 2-14, 2-17, 3-41, 4-3, 4-21, 4-22, B-9, C-5
- directed-energy weapon (DEW), A-1, A-2
- disease and non-battle injury (DNBI), 4-18, D-13
- dismounted patrol, 1-5
- displacement, 2-14, 2-18, 3-38
- distribution company, 4-1
- distribution platoon, 1-9, 1-10, 4-13, 4-14
- divert, C-7
- diving fire, 3-10, 3-69, 3-70, 3-109
- downed aircraft recovery team (DART), 2-22, 3-89, 4-9, 4-12
- downed aviator pickup point (DAPP), 2-22
- Drug Enforcement Agency, B-7
- ### E
- economy of force, 1-3, 3-17, 3-31, 3-35
- effective translational lift (ETL), 3-69
- effects coordinator, B-10
- effects coordinator (ECOORD), C-5
- electromagnetic, 2-3, 2-17
- electromagnetic pulse, 2-3
- electronic attack, C-5, C-16

electronic warfare (EW), 2-10, 2-24, 2-29, 2-32, 2-33, 3-10, 3-33, 3-63, A-2, A-4, A-6, A-8, A-9, C-1, C-4, C-7, C-16

electro-optical (EO), A-1, A-2, A-4

emergency medical team (EMT), 4-17

emergency medical treatment (EMT), 4-17

engagement, C-5, C-19

engagement area (EA), 1-5, 2-33, 3-3, 3-16, 3-19, 3-63, 3-71, 3-73, 3-74, 3-75, 3-76, 3-78, 3-80, 3-81, 3-83, A-4, B-2, B-9, C-2, C-3, C-4, C-5, C-6

engagement criteria, 2-5, 3-16, 3-19

escort, 1-5, 3-48, 3-49, 3-50, 3-51, 3-53, 3-88, 3-91, 3-92, 3-94, 3-109, D-14

estimated time en route (ETE), 3-7

estimated time of arrival (ETA), 3-2

evasive plan of action (EPA), 3-89, 3-93, 3-115, D-4

execution matrix, 2-34, 2-35

executive officer (XO), 1-7, 1-8, 2-3, 2-6, 2-7, 2-15, 2-18, 2-20, 4-17, D-3, D-16

exploitation, 3-17

explosive ordnance device (EOD), D-15

explosive ordnance disposal (EOD), 4-9

external supported recovery (ESR), 3-88

extraction, 2-25, 3-15, 3-54, 3-91, 3-92, B-8

F

feint, 1-3, 3-120, 3-121

field artillery (FA), 2-4, 2-11, 3-41, 3-64, 3-83, C-5

field feeding section, 1-9, 4-13, 4-14

field maintenance, 4-6, 4-11, 4-15, 4-16, 4-17, 4-20, 4-24

field of fire, 3-10, 3-38, 3-80, 3-98, 3-103

field of view (FOV), 3-6, 3-8, 3-112, 3-113

fighter management, 2-9, 2-22, 3-8, 3-9, 3-13, 3-47, B-10

fire control radar (FCR), 1-8, 1-9, 3-91, 3-119, 3-120

fire distribution, 3-76, 3-86

fire support (FS), 1-6, 2-4, 2-10, 2-11, 2-14, 2-16, 2-17, 2-24, 2-29, 2-34, 2-35, 3-54, 3-63, 3-77, 3-78, 3-118, 3-120, B-5, B-6, B-8, B-9, C-2, C-5, C-6, C-7, C-13, C-19

fire support coordinating measure (FSCM), C-6, C-16

fire support coordination line (FSCL), 3-33, C-4

fire support coordination measure (FSCM), 2-11

fire support element (FSE), 2-16, C-1, C-2, C-3, C-5

fire support officer (FSO), 2-5, 2-11, 2-15, 2-16, 2-24, 2-25, 3-75, C-5

fires
indirect, C-5, C-6, C-8, C-17

first sergeant (1SG), 2-12, 2-13, 2-17, 2-20, 2-26, 2-27, 2-31, 4-2, 4-3, 4-17, D-2, D-16

fix, 1-3, 3-20, 3-31, 3-32, 3-44, 3-83, 3-87, 4-9

fixed-base operation, 2-6

fixed-wing (FW), 2-25

fixing, 1-3, 3-19, 3-73, 3-87

flight lead, 3-10, C-11

flight operations officer, 2-9, 2-11, 2-12

flight surgeon, 2-7, 2-8, 2-15, 4-17

flight technique, 2-36, 3-8, 3-9, 3-27, 3-30

flow chart, 2-27, 4-7, 4-8

flying hour program, 2-10, 4-7

food service, 2-6, 2-12, 2-27, 4-14, 4-18

force protection, 2-6, 3-14, 3-16, 3-20, 3-87, 4-5, C-3, D-1

Force XXI battle command brigade and below (FBCB2), 2-2, 2-13, 2-20, 4-14

formation, 2-38, 3-2, 3-3, 3-5, 3-6, 3-9, 3-12, 3-50, 3-51, 3-53, 3-75, 3-80, 3-92, 3-93, A-6, A-7, B-15

forward air controller-airborne (FAC[A]), B-7

forward area refueling equipment (FARE), 4-14, 4-15

forward arming and refueling point (FARP), 2-3, 2-4, 2-10, 2-12, 2-15, 2-22, 2-29, 2-32, 2-33, 2-36, 2-37, 2-39, 3-1, 3-22, 3-24, 3-35, 3-54, 3-55, 3-56, 3-59, 3-64, 3-93, 3-98, 3-102, 3-119, 4-2, 4-3, 4-13, 4-14, 4-15

forward line of own troops (FLOT), 2-36, 3-43, 3-84, 3-93, 3-117, 4-15, D-5

forward maintenance team (FMT), 4-12, 4-16

forward operating base (FOB), 3-84

forward support company (FSC), 1-5

forward support troop (FST), 1-9

forward-looking infrared (FLIR), 3-3, 3-75, 3-99, B-5, C-17

fragmentary order (FRAGO), 2-17, 3-47, 3-61, 3-116

fratricide, C-4

freedom of maneuver, 3-11, 3-12, 3-20

full spectrum operation, xi, 3-14, 3-19, B-15

G

general support (GS), C-5

Global Command and Control System-Army, 2-2

global positioning system (GPS), 2-22, 2-33, 3-100, 3-117, B-8, B-9, D-8, D-9

ground control station, 2-18

ground maintenance platoon, 1-9, 1-10, 4-13, 4-15

guard, 1-5, 2-21, 3-30, 3-31, 3-33, 3-34, 3-40, 3-41, 3-42, 3-43, 3-44

gunnery, 2-11, 2-28, 2-29

H

hasty attack, 3-19, 3-44, 3-50, 3-58
 Have Quick, 2-32, 2-37, C-4, C-7
 hazardous material, 3-16
 headquarters, C-7
 headquarters and headquarters company (HHC), 1-5
 headquarters and headquarters troop (HHT), 1-9
 headquarters and support company (HSC), 4-1
 health services, 2-7
 health support service (HSS), 4-17, 4-20
 heavy brigade combat team (HBCT), B-15
 heavy expanded mobility tactical truck (HEMTT), 4-15
 helicopter gunnery skills test, 2-28
 Hellfire, 1-4, 2-25, 3-21, 3-62, 3-109, C-3, C-5
 high explosive, 3-109
 high frequency (HF), 2-2, 2-4
 high risk to capture, 3-89
 high value target (HVT), 2-23, 3-63
 high-payoff target (HPT), 2-23, 2-24, 3-13, 3-20, 3-37, B-1, C-5
 high-payoff target list (HPTL), 2-24
 holding area (HA), 3-7, 3-21, 3-64, 3-84, 3-117, B-2, B-9
 Homeland Defense, 3-95
 hover fire, 3-69
 hovering, 3-62, 3-99, 3-103
 human resources specialist, 2-14

I

identification (ID), C-5, C-16, C-17
 identification friend or foe (IFF), 2-22, 2-32, 2-38, 3-99, 3-117, 3-118, A-6, A-8, C-16
 improved data modem (IDM), 2-2, 3-119

improvised explosive device (IED), 2-8, 3-8, 3-22, 3-48
 improvised explosive device (IED), 2-8
 inadvertent instrument meteorological condition (IIMC), 2-22, 2-33, 2-34, 2-35, 2-36, 3-9
 incursion, 3-38, 3-40
 indirect fire, 1-2, 1-3, 2-8, 3-10, 3-12, 3-13, 3-16, 3-19, 3-20, 3-21, 3-32, 3-33, 3-35, 3-37, 3-38, 3-53, 3-58, 3-59, 3-63, 3-75, 3-82, 3-83, 3-94, A-1, B-3, B-4, B-5
 indirect fires, C-5, C-6, C-8, C-17
 individual aircrew training folder (IATF), 2-28, A-9
 infantry brigade combat team (IBCT), B-16
 infantry fighting vehicle, 3-111
 information operation, 2-11
 infrared (IR), 2-17, 3-3, 3-6, 3-52, 3-60, 3-62, 3-70, 3-113, A-1, A-4, A-8, B-4, B-5, B-6, B-7, C-3, C-5, C-12, C-16, C-17, D-5
 instructor pilot (IP), 2-11, C-12, C-19
 instrument examiner, 2-28
 instrument flight, 2-29
 intelligence, C-3
 intelligence estimate, 2-7, 2-8
 intelligence officer (S2), C-3, C-5
 intelligence preparation of the battlefield (IPB), 1-2, 2-7, 2-9, 3-7, 3-12, 3-22, 3-27, 3-58, 3-71, 3-72, 3-81, C-3, C-4, C-6
 intelligence report (INTREP), 2-3, 2-17
 intelligence summary, 2-17
 intelligence, surveillance, and reconnaissance (ISR), 1-2, 2-8, 2-9, 3-21, 3-63, 3-88, B-1, B-2
 interdiction attack, 1-3, 2-36, 3-59, 3-63
 isolated personnel, 3-89, 3-90, 3-91, 3-94, D-5, D-6

isolated personnel report (ISOPREP), 2-9, 3-89, 3-93, D-4, D-6
 isolated, missing, detained, or captured (IMDC), 3-87, 3-88, 3-91, 3-93

J

joint air attack team (JAAT), 1-3, 2-4, 2-37, 3-19, 3-58, 3-63, 3-64, 3-82, 3-110, B-3, C-1, C-2, C-3, C-4, C-5, C-6, C-7, C-8, C-10, C-11, C-13, C-16, C-17, C-18, C-19
 joint fire, 3-10, 3-58, 3-59, 3-63, 3-82, 3-86
 joint force air component commander (JFACC), C-8
 joint force commander (JFC), C-1, C-8
 joint personnel recovery center (JPRC), 3-89
 joint publication (JP), C-1, C-4, C-5, C-6, C-10
 joint suppression enemy air defense (J-SEAD), 2-11, 3-6, 3-10, 3-21, 3-54, A-6, B-4
 joint suppression of enemy air defense (J-SEAD), C-6

K

kill zone, 3-21, 3-55

L

landing zone (KZ), 3-53
 landing zone (LZ), 1-3, 2-17, 3-27, 3-28, 3-30, 3-50, 3-53, 3-54, 3-93, 3-94, 3-102, 3-109, 3-110, 3-111, 3-113, B-2, B-9, D-9
 landing zone L(Z), 3-29
 laser, 1-2, 3-2, 3-70, 3-75, 3-109, 3-110, 3-113, 3-114, 3-119, A-1, A-2, B-5, B-6
 lead, 1-4, 2-1, 2-31, 3-2, 3-3, 3-4, 3-5, 3-6, 3-7, 3-9, 3-12, 3-18, 3-31, 3-33, 3-38, 3-39, 3-41, 3-43, 3-48, 3-51, 3-62, 3-85, 3-86, 3-100, 3-103, 3-112, 3-116, 3-119, 4-13, B-1
 liaison, 1-2, 2-6, 2-8, 2-9, 2-10, 3-118, 4-5, 4-16, B-7, B-10, C-2
 liaison officer (LNO), C-5

lift, 3-28, 3-52, 3-91, 3-114
 limit of advance (LOA), 3-13, 3-16, 3-17, 3-23, 3-25, 3-27, B-9
 line of communication (LOC), 1-4, 1-5, 3-19, 3-21, 3-30, 3-31, 3-33, 4-14
 line of departure (LD), 3-23, 3-25, 3-26, 3-27
 line of sight (LOS), 2-25, 3-7, 3-69, 3-112, 3-114, A-1, A-2, B-6
 line replacement unit (LRU), 4-7, 4-13, 4-20
 linkup, 2-25, 3-91
 local area network (LAN), 2-12, 4-16, 4-24
 logistic support area (LSA), 2-21
 logistics assistant representative (LAR), 4-19, 4-20
 logistics estimate, 2-7, 2-12
 logistics package (LOGPAC), 2-13, 4-3, 4-14
 logistics release point (LRP), 4-2, 4-15
 logistics section, 2-15
 logistics support area (LSA), 2-21
 low-level, 3-6

M

main CP, 2-5, 2-6, 2-7, 2-14, 2-15, 2-16, 2-17, 2-18, 2-19, 2-20, 2-21, 2-26, 4-5
 main support battalion, 4-18
 maintenance, 2-12, 2-39, 4-6, 4-8, 4-11, 4-13, D-1, D-16
 maintenance allocation chart (MAC), 4-6, 4-12, 4-19, 4-20
 maintenance management, 1-11, 4-19, 4-21, 4-24, 4-25
 maintenance operational check, 2-29, 4-11
 maintenance test flight, 2-29
 maintenance test pilot (MP), 1-11, 2-29, D-2
 maneuver space, 1-4, 3-6, 3-30, 3-31, 3-34, 3-38, 3-48, 3-81
 march column, 2-19

marshalling area, 2-19
 massed attack, 1-5
 master gunner, 2-11, 2-28
 materiel management center (MMC), 4-3, 4-4, 4-5
 materiel readiness officer, 2-6
 maximum destruction, 3-64
 medical estimate, 2-8
 medical evacuation (MEDEVAC), 2-19, 3-50, 3-114, 4-17
 medical treatment squad, 1-6, 4-16
 military decision making process (MDMP), 2-10, 2-22, 2-23, 2-30, 3-120, 4-20, B-2
 military operation, 2-2, 2-25, 3-14, 3-15, 4-1, 4-19, A-2
 mission essential task list (METL), 2-13, 2-27, 2-28, 3-95, 3-97, 3-114, B-10
 mission oriented protective posture (MOPP), 2-14
 mission planning, C-3
 mission training plan (MTP), 4-17, D-3
 mission, enemy, terrain and weather, troops and support available, time available, and civil consideration (METT-TC), 2-5, 2-15, 2-18, 2-19, 2-20, 2-30, 3-2, 3-3, 3-4, 3-6, 3-7, 3-8, 3-10, 3-12, 3-16, 3-17, 3-20, 3-27, 3-33, 3-38, 3-44, 3-48, 3-49, 3-50, 3-51, 3-52, 3-53, 3-54, 3-84, 3-93, 3-96, 4-2, 4-9, 4-15
 mobility, C-17
 movement control, 1-4, 4-18
 movement order, 2-19, 2-20
 movement technique, 3-2, 3-3, 3-6, 3-7, 3-9, 3-10, 3-23, 3-26, 3-27, 3-118
 movement to contact, 1-3, 1-4, 1-5, 3-1, 3-43, 3-58, 3-80, 3-86, 3-87, C-5

N

named area of interest (NAI), 3-17, 3-26, 3-35, 3-54, 3-72, 3-112, C-3

nap-of-the-earth (NOE), 3-6, 3-8, 3-9, 3-10, 3-69, 3-84, C-2
 naval surface fire support (NSFS), 2-24, 3-6, 3-63, B-10, C-1, C-2, C-5
 navigational aid (NAVAID), 3-20, 4-10
 network control station, 2-4
 network support company, 4-1
 night vision device (NVD), 2-25, 3-6, 3-8, 3-54, 3-99, 3-102, 3-113, 3-114, 3-115, 4-5, B-5, B-6, C-5, D-9
 night vision goggle (NVG), 2-29, 3-3, 3-5, B-4, B-5, B-6, C-11, C-17
 night vision system, 3-5, 3-6
 no fire area (NFA), 3-47, B-2
 noncombatant evacuation operation (NEO), D-1
 nonlethal, C-6, C-16
 no-notice evaluation, 2-28
 no-notice program, 2-28
 not mission capable (NMC), 4-21
 notice to airmen (NOTAM), 2-33, 2-34, 2-35

O

objective area, 2-36, 3-6, 3-27, 3-28, 3-30, 3-46, 3-47, 3-50, 3-53, 3-82, 3-89, 3-90, 3-91, 3-93, 3-94, 3-104, 3-105, 3-112, 3-113, D-6, D-7
 observation, 1-5, 2-5, 2-17, 3-3, 3-4, 3-5, 3-6, 3-10, 3-12, 3-17, 3-19, 3-20, 3-21, 3-23, 3-30, 3-31, 3-33, 3-35, 3-37, 3-38, 3-40, 3-46, 3-47, 3-54, 3-56, 3-83, 3-106, 3-112, 3-113, D-10
 observation and fields of fire, avenues of approach, key terrain, obstacles and movement, and cover and concealment (OAKOC), 3-14
 observation post (OP), 1-5, 2-33, 3-33, 3-35, 3-36, 3-37, 3-38, 3-39, 3-42, 3-43, 3-44, 3-47, 3-54, 3-55, 3-56, 3-57, 3-112
 observer controller, 2-40

- obstacle, 3-2, 3-12, 3-23, 3-26, 3-32, 3-52, 3-96, 3-113
- offensive operation, 2-17, 2-26, 3-1, 3-37, 3-44, 3-58, 3-116
- OH-58D, C-1
- on-scene commander (OSC), 3-89, 3-90, D-4, D-6, D-7
- operating order (OPORD), 2-17, 2-32, 2-34, 3-11, 3-12, 3-13, 3-19, 3-72, 3-96, 3-114, 3-120, 4-10, 4-19, A-2, B-9, B-11, D-16
- operating tempo (OPTEMPO), 3-60, 3-114, 4-13
- operation characteristics tempo, C-17
- operational control (OPCON), 2-2, 2-27, 3-116, 4-3, C-8
- operational environment, 1-1, 1-2, 1-9, 1-11, 2-5, 2-7, 2-8, 2-13, 3-1, 3-9, 3-12, 3-14, 3-32, 3-34, 3-35, 3-58, 3-63, 3-75, 3-87, 3-95, 3-98, 3-118, 4-1, 4-5, B-1, B-3, B-9
- operational exposure guidance, 2-14
- operational plan (OPLAN), 2-17, 3-96
- operational readiness rate, 4-7, 4-8
- operations
defensive, C-1
support, C-1
- operations and intelligence (O&I), 2-3, 2-4
- operations cell, 2-15, 2-32, 2-33, 3-114
- operations estimate, 2-7, 2-9
- operations security (OPSEC), 2-3
- overwatch, 3-12, 3-22, 3-26, 3-118, D-8
- P**
- palletized load system (PLS), 4-15, D-6, D-7
- passage of line, 2-22
- passage of lines, 2-36
- passage point (PP), 2-32, D-5
- performance planning card (PPC), 2-32, 2-34, 2-35
- perimeter, 2-20, 4-4, 4-6
- permissive, 3-24, 3-28, 3-92
- personal staff, 1-7
- personnel estimate, 2-7, 2-8
- personnel readiness, 2-7
- personnel recovery (PR), 2-5, 2-10, 2-29, 2-35, 3-47, 3-87, 3-88, 3-89, 3-90, 3-91, 3-92, 3-93, 4-9, C-7, D-4, D-5, D-6
- personnel recovery
coordination cell (PRCC), 3-89, 3-93
- personnel recovery officer (PRO), 3-89
- phase line (PL), 3-23, 3-26, 3-27, 3-33, 3-36, 3-38, 3-42, 3-117
- phase maintenance, 4-8
- phased attack, 3-64
- phases/progressive preventive maintenance, 2-27
- pickup zone (PZ), 1-3, 3-28, 3-29, 3-30, 3-50, 3-52, 3-54, 3-102, 3-110, 3-113, B-2, D-14
- pilot in command (PC), 2-5, 2-26, 2-27, 2-35, 3-2, 3-115
- planning
responsibilities, C-7
- Planning
process, C-3, C-4
- planning cell, 2-28, 2-31, 2-32, 2-33
- plans cell, 2-15, 2-16
- platoon leader, 2-27, 2-28, 2-29, 3-2
- platoon sergeant, 2-27, 2-29, 4-5
- postal service, 2-7
- precombat check (PCC), 2-19, 2-38
- precombat inspection (PCI), 2-19, 2-20, 2-38
- prescribed load list (PLL), 4-12, 4-16, 4-19, 4-24
- preventive maintenance checks and services (PMCS), 2-38, 4-11, 4-22, D-3
- preventive medicine, 4-17
- priority fire zone (PFZ), 3-78
- priority intelligence requirement (PIR), 1-2, 2-39, 3-30, 3-31, 3-33, 3-47, A-4
- priority of fire, 3-41
- priority of fire zone (PFZ), 3-78, 3-86
- problem, plan, people, parts, time and tools (P4T2), 4-7, 4-9, 4-10
- production control, 1-9, 1-11, 4-8, 4-12, 4-13, 4-19, 4-20, 4-24
- progressive phase maintenance (PPM), 4-8
- Property Book and Unit Supply System-Enhanced (PBUSE), 4-22, 4-23
- property book officer (PBO), 4-5, 4-22
- psychological operations (PSYOPS), 2-24, 3-34
- pursuit, 3-17, 3-117
- Q**
- quality assurance (QA), 1-9, 1-11, 4-12, 4-19
- quartering party, 2-6, 2-13, 2-19, 2-20, 2-21
- quick reaction force (QRF), 1-2, 1-4, 2-6, 2-21, 2-35, 3-40, 3-42, 3-89, 3-92, 3-114, 3-115, 3-116, 4-9
- R**
- racetrack, 3-62
- radar frequency (RF), 2-25, 3-70, A-4, A-8
- radio telephone operator (RTO), 2-16
- raid, 1-3
- rally point, 2-19, 2-20
- range fan, 3-77
- readiness condition (REDCON), 3-114
- reconnaissance, 3-10, 3-13, 3-15, 3-16, 3-17, 3-54, C-1, C-2, C-3, C-4, C-5, C-16
aerial, C-8
- reconnaissance and surveillance (R&S), 1-3, 1-4, 3-20, 3-121
- reconnaissance-by-fire, 3-18, 3-20, 3-21
- recoverable, 2-28

rehearsal, 2-19, 2-21, 2-35, 2-36, 2-37, 2-38, 3-73, 3-78, 3-80, 3-82, 3-115, A-2, B-9

relay, C-4, C-7, C-8

release point (RP), 2-19, 2-20, 2-21, 2-37, 3-22, 3-23, 3-48, 3-86, D-8, D-11, D-12

reparable exchange (RX), 4-20

required supply rate (RSR), 4-4

rescue escort (RESCORT), 3-89, 3-90, 3-91, 3-94, D-6, D-7, D-9

rescue mission brief (RMB), 3-90, 3-93, 3-94

rescue mission commander (RMC), 3-90, 3-91, 3-93, 3-94, D-6, D-7

reserve, 2-16, 2-32, 3-37, 3-42, 3-54, 3-55

restricted fire area (RFA), 3-47

restricted operating zone (ROZ), 3-90, B-2

retransmission (RETRANS), 2-2, 2-12

return to duty (RTD), 2-13, D-13

return to force (RTF), 4-24

risk assessment, 2-29, 2-33, 2-34, 2-35, 3-115, A-2, A-3, A-4

risk management, 2-5, 2-10, 2-11, 2-29

road march, 2-19

rules of engagement (ROE), 2-5, 2-37, 3-16, 3-37, 3-47, 3-93, 3-96, 3-97, 3-98, A-6, B-1, C-7

rules of instruction (ROI), 3-96, 3-97, 3-98

running estimate, 2-7

running fire, 3-10, 3-69, 3-70, 3-103

S

safety, C-19

safety officer (SO), 2-11, 2-15, 2-18, 2-29, 2-31, 4-14

satellite communication (SATCOM), 2-2, 2-4

scheduled maintenance, 2-27, 4-8

scheme of maneuver, C-13

scout weapons team (SWT), 3-2, 3-3, 3-4, 3-48, 3-49, 3-50, 3-51, 3-53, 3-58, 3-62, 3-63

screen, 1-5, 3-34, 3-35, 3-38, 3-54, 3-110

screen line, 3-33, 3-36, 3-38, 3-39, 3-42, 3-54, 3-56

search and attack, 3-86, 3-87

search and rescue (SAR), 3-88, 3-89, D-7

search and rescue incident report (SARIR), 3-93, D-7

sector of fire, 3-77, 3-106

security, 3-30, 3-31

security clearance access roster (SCAR), A-9

semiaactive laser, 2-25

serial, 2-19, 4-22

sets, kits, and outfits (SKO), 4-13

sets, kits, outfits, and special tools (SKOT), 4-6

shop equipment contact maintenance (SECM), 4-19, 4-20

signal officer (S6), 2-12, 2-15, 2-17, 2-20

signal operation instruction (SOI), 2-12

simultaneous attack, 1-5

single channel air-ground radio system (SINCGARS), 2-11, 2-32, B-9

situational awareness (SA), 1-2, 1-4, 2-2, 2-5, 2-16, 3-6, 3-36, 3-38, 3-58, 3-59, 3-61, 3-97, 3-112, 3-119, A-6, B-5, B-9, C-16, C-17

situational training exercise (STX), 2-28, 2-29, A-9, B-8

situational understanding (SU), 1-2, 2-14, 2-16, 2-18, C-16

small scale contingency (SSC), 1-2, 3-98

small unmanned aircraft system (SUAS), 2-18

special instructions (SPINS), 2-9, 2-22, 2-24, 3-89, 3-93

special staff, 1-7

specific information requirement, 3-13

spider web, 3-100

split-based operation, 2-26, 3-96, 4-17, 4-19, B-9

spot report (SPOTREP), 2-37, 2-39, 3-80, 3-82, 3-83, D-10

stability, 1-2, 3-1, 3-13, 3-14, 3-15, 3-34, 3-69, 3-95, 3-96, 3-97, 3-98, 4-23

standard Army maintenance system (SAMS), 4-23

standard Army maintenance system-enhanced (SAMS-E), 4-22

standard Army maintenance system-level 1 (SAMS-1), 4-20, 4-21, 4-22

standard Army maintenance system-level 2 (SAMS-2), 4-20, 4-21, 4-22

standard Army maintenance-enhanced (SAMS-E), 4-22

standard Army management information system (STAMIS), 4-12, 4-14, 4-19, 4-20, 4-23, 4-24

standard Army retail supply system (SARSS), 4-16, 4-22, 4-23

standard Army retail supply system-gateway (SARSS-Gateway), 4-23

standard Army retail supply system-Gateway (SARSS-Gateway), 4-21, 4-23

standard Army retail supply system-level 1 (SARSS-1), 4-16, 4-23

standard Army retail supply system-level 2 (SARSS-2), 4-23

standardization instructor pilot (SP), 2-11, 2-28, 2-31, A-9

standing operating procedure (SOP), C-4

status chart, 2-27

stay behind equipment, 4-5

straight trail, 3-4

Stryker brigade combat team (SBCT), 1-5, B-15

supply point distribution, 4-2

supply section, 1-6, 4-16, 4-19

supply sergeant, 2-13, 4-16

- supply support activity (SSA), 4-5, 4-17, 4-19, 4-23
- support area, 2-12, 2-13, 2-15, 4-3, D-3
- support by fire (SBF), 2-33, 3-19, 3-21, 3-119, B-3
- support relationships
direct support (DS), C-5
general support (GS), C-5
- suppression, C-6
- suppression enemy air defense (SEAD), 3-73, 3-93, B-4, F-3, 4, 5
- suppression of enemy air defense (SEAD), C-2, C-5, C-6, C-8, C-12, C-15, C-16
- suppressive fire, 3-4, 3-12, 3-51, 3-58, 3-103, 3-109, 3-110, 3-113
- surveillance, 1-3, 1-5, 2-3, 2-18, 3-3, 3-6, 3-10, 3-11, 3-21, 3-27, 3-30, 3-33, 3-35, 3-36, 3-41, 3-45, 3-86, 3-110
- survey, 2-3, 2-14, 2-18, 2-29, 3-28, D-9
- survivability, C-3, C-5, C-6
- survival, escape, rescue, and evasion, 2-5
- sustainment, xi, 1-4, 1-9, 2-1, 2-11, 2-13, 2-14, 2-16, 2-17, 2-19, 3-12, 3-17, 3-19, 3-30, 3-31, 3-64, 3-73, 3-97, 4-1, 4-2, 4-3, 4-5, 4-6, 4-14, 4-15, 4-16, 4-17, 4-19, 4-20, 4-22, B-9, B-15
- sustainment maintenance, 4-6
- synchronization matrix, 2-9
- ### T
- tactical air control party (TACP), C-3, C-5, C-7, C-11
- tactical airspace integration system, 2-2
- tactical combat force (TCF), 4-5
- tactical control (TACON), 3-116, C-1, C-8
- tactical fire direction system (TACFIRE), 2-4
- tactical operations center (TOC), 2-3, 2-4, 2-7, 2-11, 2-15, 2-16, 2-18, 2-20, 2-21, 3-89, 4-9, 4-17, D-12
- tactical satellite, 2-2
- tactics, techniques, and procedures (TTP), 2-10, 2-27, 2-29, 2-36, 3-3, 3-10
- target acquisition (TA), 2-24, 3-10, C-1, C-19, C-20, D-3
- target handover, 3-3, 3-61, 3-113
- target reference point (TRP), 2-33, 3-60, 3-76, 3-105, 3-106, B-4
- targeting, 2-23, 2-24, 3-3, 3-13, 3-14, 3-69, 3-104, 3-105, 3-106, C-13
- task force (TF), 1-2, 2-13, 2-26, 3-7, 3-37, 3-38, 3-42, 3-53, 3-54, 3-92, 3-114, 3-115, 3-116, B-10
- task organization, 2-1, 2-17, 2-20, 3-34, 3-61, 3-96
- team brief, 2-35
- technical supply, 4-12, 4-19
- terminal area phase, 3-94
- terrain flight, 3-5, 3-6, 3-7, 3-8, 3-9, 3-10, 3-26, 3-70, 3-86
- terrain management, 1-4, 2-17
- terrain model, 2-19, 2-36
- threat, C-3, C-5, C-6, C-17
- throughput distribution, 4-2
- time on target (TOT), 2-24, 2-37
- time/distance/heading (TDH), 2-32
- traffic control post (TCP), 3-45
- trail, 3-2, 3-6, 3-9, 3-36, 3-43, 3-48, 3-49, 3-91, 3-119
- training, C-1, C-2, C-4, C-7, C-8
- training meeting, 2-28
- traveling, 3-6, 3-9, 3-36, 3-47
- traveling overwatch, 3-6, 3-9
- trigger, 3-13, 3-19, 3-30, 3-76, 3-80, 3-83
- troop leading procedures (TLP), 2-19
- ### U
- ultra high frequency (UHF), 2-3, 2-4, 3-89
- unexploded ordnance (UXO), D-15
- unit basic load (UBL), 4-4
- unit distribution, 4-2
- unit maintenance, 1-11, 2-29, 4-6, 4-7, 4-8, 4-11, 4-19
- unit ministry team (UMT), 1-6, 1-9, 2-8, 2-15, 4-16, 4-18, D-2
- unit trainer, 2-29
- unit-level logistics system (ULLS), 4-21
- unit-level logistics system-aviation (ULLS-A), 4-8, 4-18, 4-23, 4-24
- unit-level logistics system-logistics officer (ULLS-S4), 4-3
- unit-level logistics system (ULLS), 4-23
- unit-level maintenance, 2-12, 4-11, 4-16
- unmanned aerial system (UAS), 2-12, 2-24, 3-12, 3-30, 3-34, 3-54, 3-75, 3-99, 3-112, 3-120, 4-17, 4-19, B-3, B-10, F-2
- unmanned aircraft systems (UAS), C-4
- unscheduled maintenance, 2-27, 4-8, 4-9, 4-11, 4-12, 4-13
- urban operation, 2-17, 3-10, 3-31, 3-32, 3-98, 3-109, 3-111
- ### V
- vehicle-borne improvised explosive device (VBIED), 3-8, 3-22
- very high frequency (VHF), 2-3, 2-4, 3-89
- video, 2-39, 3-20, 3-28
- ### W
- warning order (WARNO), 2-18, 2-20, 2-31, 2-32, D-15
- waypoint, 3-17, 3-119
- weather, C-4, C-6
- wedge formation, C-20
- wingman, 1-4, 3-2, 3-3, 3-4, 3-5, 3-6, 3-89, 3-103, D-6

FM 3-04.126

16 February 2007

By order of the Secretary of the Army:

PETER J. SCHOOMAKER
General, United States Army
Chief of Staff

Official:



JOYCE E. MORROW
Administrative Assistant to the
Secretary of the Army
0702602

DISTRIBUTION:

Active Army, Army National Guard, and U.S. Army Reserve: To be distributed in accordance with the initial distribution number (IDN) 110712, requirements for FM 3-04.126.

This page intentionally left blank.

