

**FM 4-20.147 (FM 10-547)
AIR FORCE TO 13C7-37-31**

**AIRDROP OF SUPPLIES AND EQUIPMENT:
Humanitarian Airdrop**

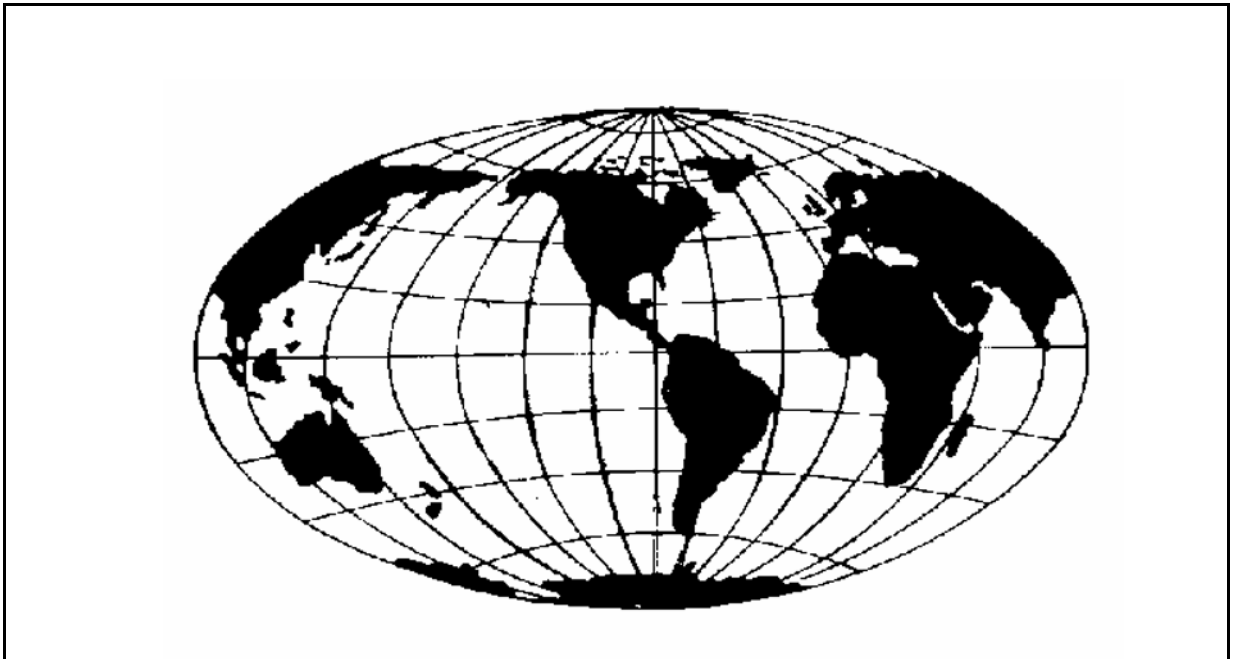

NOVEMBER 2003

DISTRIBUTION RESTRICTION: Approved for public release; distribution is unlimited.

**HEADQUARTERS
DEPARTMENT OF THE ARMY
DEPARTMENT OF THE AIR FORCE**

**This publication is available at Army
Knowledge Online (www.us.army.mil)
and the General Dennis J. Reimer
Training and Doctrine Digital Library at
(www.adtdl.army.mil)**

HEADQUARTERS
DEPARTMENT OF THE ARMY
DEPARTMENT OF THE AIR FORCE
Washington, DC, 4 January 2005

**AIRDROP OF SUPPLIES AND EQUIPMENT:
HUMANITARIAN AIRDROP**

This change adds the rigging procedures for low-velocity Low Cost Aerial Delivery System.

FM 4-20.147/TO 13C7-37-31, 28 November 2003, is changed as follows:

1. New or changed material is identified by a vertical bar () in the margin opposite the changed material.
2. File the transmittal sheet in front of the publication for reference purpose.
3. Remove old pages and insert new pages as indicated below:

Remove old pages

i through v
3-3 and 3-4

Insert new pages

i through v
3-3 and 3-4
3-11 through 3-17

DISTRIBUTION RESTRICTION: Approved for public release; distribution is unlimited.

By Order of the Secretary of the Army and the Air Force:

PETER SCHOOMAKER
General, United States Army
Chief of Staff

Official:



SANDRA R. RILEY
Administrative Assistant to the
Secretary of the Army
0433803

GREGORY S. MARTIN
General, USAF
Commander, AFMC

JOHN P. JUMPER
General, USAF
Chief of Staff

DISTRIBUTION:

Active Army, Army National Guard, and U.S. Army Reserve: To be distributed in accordance with the initial distribution number 110929, requirements for FM 4-20.147.

This publication is available at Army
Knowledge Online (www.us.army.mil)

Field Manual
NO 4-20.147
Technical Order
NO 13C7-37-31

HEADQUARTERS
DEPARTMENTS OF THE ARMY
AND THE AIR FORCE
Washington, DC, 4 January 2005

Airdrop of Supplies and Equipment: Humanitarian Airdrop

Contents

| | Page | |
|----------------------|---|-----|
| Preface | v | |
| Chapter 1 | General Rigging Information Humanitarian Airdrop Loads | |
| Section I | Description of Humanitarian Loads | |
| | Humanitarian Airdrop Methods | 1-1 |
| Section II | Parachute Requirements and Packing Procedures | |
| | Parachute Requirements | 1-2 |
| | Packing the Reefed G-12 and 68-inch Diameter Pilot Parachutes | 1-3 |

Distribution Restrictions: Approved for public release; distribution is unlimited.

* This publication supersedes FM 10-547/TO 13C7-37-31, dated 29 September 1980

| | | |
|------------------|---|-----|
| Chapter 2 | Rigging Extended Tri-Wall Airdrop System (TRIADS) | |
| Section I | General Rigging Information for Extended TRIADS | |
| | TRIADS System Components | 2-1 |
| | TRIADS Skid Board | 2-1 |
| | TRIADS Container Limitations | 2-2 |
| | Assembly Line Rigging | 2-2 |
| | Inspection of Load | 2-2 |
| | Parachute Used | 2-2 |
| | AFT Restraint | 2-2 |
| Section II | Rigging Extended TRIADS Containers | |
| | System Description | 2-3 |
| | Preparing Items and Skid Board | 2-3 |
| | Preparing Honeycomb Base | 2-3 |
| | Preparing Straps and Static Line | 2-4 |
| | Preparing End Caps | 2-4 |
| | Installing Skid Board | 2-5 |
| | Assembling the Box | 2-6 |
| | AFT Restraint TRIADS and Honeycomb Kit | 2-6 |
| | Filling the TRIADS Container | 2-6 |
| | Installing Vertical Strap and Static Line | 2-8 |
| | Marking Rigged Load | 2-9 |
| Chapter 3 | Rigging Low Cost High Velocity Container Delivery System (LCADS) | |
| Section I | General Information for LCADS | |
| | LCADS System Components | 3-1 |
| | LCADS Skid Board | 3-1 |
| | LCADS Container Limitations | 3-2 |
| | Inspection of Load | 3-2 |
| | Parachute used | 3-2 |
| Section II | Rigging High-Velocity LCADS | |
| | System Description | 3-3 |
| | Preparing Items and Skid Board | 3-3 |
| | Preparing and Placing Honeycomb | 3-4 |
| | Positioning Sling Assembly | 3-5 |
| | Positioning Load and Securing Sling Assembly | 3-6 |
| | Securing Sling Assembly to Skid Board | 3-7 |
| | Installing Parachute | 3-8 |
| | Marking Rigged Load | 3-9 |
| | Equipment Required | 3-9 |

| | Page |
|--------------------|--|
| Section III | Rigging Low Velocity LCADS |
| | System Description 3-11 |
| | Preparing Items and Skid Board 3-11 |
| | Preparing and Placing Honeycomb 3-11 |
| | Positioning Sling Assembly 3-12 |
| | Positioning Load and Securing Sling Assembly 3-13 |
| | Securing Sling Assembly to Skid Board 3-15 |
| | Installing Parachute 3-15 |
| | Marking Rigged Load 3-16 |
| | Equipment Required 3-16 |
| Chapter 4 | Rigging Double A-22 Cargo Bag for High Velocity Airdrop |
| Section I | General Information for Double A-22 Cargo Bag |
| | Double A-22 Cargo Bag Components 4-1 |
| | Double A-22 Cargo Bag Skid Board 4-1 |
| | Double A-22 Cargo Bag Limitations 4-2 |
| | Assembly Line Rigging 4-2 |
| | Inspection of Load 4-2 |
| | Parachute Used 4-2 |
| Section II | Rigging Double A-22 Cargo Bag |
| | System Description 4-3 |
| | Preparing Items and Skid Board 4-3 |
| | Preparing Skid Board Ties and Placing Honeycomb 4-4 |
| | Positioning A-22 Sling Assembly 4-5 |
| | Positioning Covers and Honeycomb 4-7 |
| | Positioning Load and Closing Bag Covers 4-8 |
| | Securing Tie-Down Straps 4-9 |
| | Securing Lateral Straps 4-10 |
| | Securing Skid Board Ties 4-11 |
| | Installing Suspension Slings 4-12 |
| | Installing Parachute 4-13 |
| | Marking Rigged Load 4-14 |
| | Equipment Required 4-14 |
| Section III | Alternate Rigging Method for Double A-22 Cargo Bag |
| | Building and Positioning A-22 Containers 4-16 |
| | Joining A-22 Containers 4-17 |
| | Attaching Suspension Webs 4-18 |
| | Tying Off Unused Suspension Webs 4-19 |
| | Installing Suspension Slings 4-19 |

| | Page |
|------------------|---|
| Chapter 5 | Rigging Quadruple A-22 Cargo Bag Loads for High Velocity Airdrop |
| Section I | General Information for Quadruple A-22 Cargo Bag |
| | Quadruple A-22 Cargo Bag Components 5-1 |
| | Quadruple A-22 Cargo Bag Skid Board 5-1 |
| | Quadruple A-22 Cargo Bag Limitations 5-2 |
| | Assembly Line Rigging 5-2 |
| | Inspection of Load 5-2 |
| | Parachute Used 5-2 |
| Section II | Rigging Oversized Items in Quadruple A-22 Cargo Bags |
| | System Description 5-3 |
| | Preparing Items and Skid Board 5-3 |
| | Preparing Skid Board Ties and Placing Honeycomb 5-5 |
| | Positioning A-22 Sling Assemblies 5-7 |
| | Positioning A-22 Covers 5-10 |
| | Constructing Storage Box and Preparing Oversized Item Load 5-12 |
| | Positioning Load and Closing Bag Covers 5-15 |
| | Securing Tie-Down Straps 5-16 |
| | Securing Lateral Straps 5-17 |
| | Securing Skid Board Ties 5-18 |
| | Installing Suspension Slings 5-19 |
| | Installing Parachute 5-20 |
| | Marking Rigged Load 5-21 |
| | Equipment Required 5-21 |
| Section III | Rigging Food and Medical Items in Quadruple A-22 Cargo Bags for High Velocity Airdrop |
| | Preparing and Positioning Food and Medical Loads 5-23 |
| | Glossary Glossary-1 |
| | References References-1 |

Preface

This manual tells and shows how to prepare and rig the following configurations of Humanitarian loads, Extended Tri-Wall Airdrop System (TRIADS), Low Cost High Velocity Container Delivery System (LCADS), Double A-22 Cargo Bag for High Velocity Airdrop and Quadruple A-22 Cargo Bag for High Velocity Airdrop from a C-17 and C-130 aircraft.

User Information

The proponent of this publication is HQ TRADOC. You are encouraged to report any errors or omissions and to suggest ways of making this a better manual.

Army personnel, send your comments on DA Form 2028 directly to:

Director
Aerial Delivery and Field Services Department
USA Quartermaster Center and School
1010 Shop Road
Fort Lee, Virginia 23801-1502

Air Force personnel, send your reports on AFTO Form 22 through your respective command Weapons and Tactics to:

Headquarters
Air Mobility Command (AMC/A39T)
402 Scott Drive, Unit 3AI
Scott AFB, Illinois 62225-5302

Air Force personnel in Special Operations Command, send your reports on AFTO Form 22 HQ AMC/A39T will consolidate and forward changes to:

Director
Aerial Delivery and Field Services Department
USA Quartermaster Center and School
1010 Shop Road
Fort Lee, Virginia 23801-1502

Also send an information copy of AFTO Form 22 to:

WR-ALC/LKCB
460 Richard Ray Blvd.
Robins AFB, Georgia 31098-1640

Chapter 1

General Rigging Information Humanitarian Airdrop Loads

SECTION I - DESCRIPTION OF HUMANITARIAN LOADS

HUMANITARIAN AIRDROP METHODS

1-1. Humanitarian airdrop utilizes the Container Delivery System (CDS), some variation of that system, or TRIADS, a special method of free drop. Many factors can influence the delivery method used.

a. EXTENDED TRI-WALL AERIAL DELIVERY SYSTEM (TRIADS). The TRIADS system is a corrugated tri-wall box rigged for static line deployment off the ramp of an aircraft using CDS procedures. Typical loads include loose Meals Ready-to-Eat (MREs) or Humanitarian Daily Rations (HDRs). Following deployment the caps of the box separate from the sleeve allowing the container's content to scatter and freefall to the ground. TRIADS has a 1,375 pound load capacity. Chapter Two of this manual covers rigging TRIADS for airdrop.

b. LOW-COST AERIAL DELIVERY SYSTEM (LCADS). LCADS is a modified, lightweight A-22 system with no scuff pad, cover, or friction adapters on the lateral bands. It is rigged like a high-velocity A-22 load, but uses one of several special parachutes. LCADS is used for high-volume delivery of nonfragile items where airdrop equipment is not recoverable. LCADS has a 2,200 pound load capacity. Chapter Three of this manual covers rigging LCADS for airdrop.

c. DOUBLE A-22 CONTAINER. The double A-22 container consists of two A-22 sling assemblies. The covers may or may not be used. Only six of the suspension webs are used. The double A-22 cargo bag has a 3,375 pound load capacity. Chapter Four of this manual covers rigging the double A-22 cargo bag.

d. QUADRUPLE A-22 CONTAINER. The quadruple A-22 container consists of four standard A-22 sling assemblies which can be laced together to form one large container, or can be individually rigged and then configured side-by-side for unitized delivery of four loads. The quadruple A-22 cargo bag has a 4,375 pound load capacity. Chapter Five of this manual covers rigging the quadruple A-22 container.

SECTION II - PARACHUTE REQUIREMENTS AND PACKING PROCEDURES

PARACHUTE REQUIREMENTS

1-2. The parachute requirements for humanitarian airdrop are described below.

a. EXTENDED TRI-WALL AERIAL DELIVERY SYSTEM (TRIADS).

There is no parachute used for TRIADS. The TRIADS uses the free drop method.

b. LOW-COST AERIAL DELIVERY SYSTEM (LCADS). LCADS employs a 26-foot low cost parachute for high-velocity (HV) airdrop. The 26-foot low cost parachute is made from more readily available and more economical materials than the standard 26-foot ringslot parachute. The 26-foot low cost parachute performs identically to the standard 26-foot parachute except the low cost parachute is designed for one-time use, whereas the standard 26-foot parachute is designed for reuse. The low cost parachute is pre-packed and ready to attach to the load. Like the standard 26-foot parachute, the low cost parachute is deployed using a breakaway static line for high altitude operations. The 26-foot low cost parachute can support suspended weights from 501 to 2,200 pounds.

c. DOUBLE A-22 CONTAINER. The double A-22 container employs a reefed G-12 parachute with both skirt and vent reefing. The reefing of the G-12 parachute provides for high-velocity ballistics similar to the standard HV CDS. A standard 68-inch pilot parachute is used to deploy the reefed G-12 and a breakaway static line is used to deploy the 68-inch pilot parachute. The reefed G-12 parachute can support suspended weights from 2,201 to 3,375 pounds. The reefed G-12 and 68-inch pilot parachutes are packed according to Chapter 1, Section II, Paragraphs 1-3 through 1-5 of this manual.

d. QUADRUPLE A-22 CONTAINER. The quadruple A-22 container employs the same reefed G-12 parachute (skirt and vent reefing) that is used with the double A-22 container. A standard 68-inch pilot parachute is also used to deploy the reefed G-12 and a breakaway static line is used to deploy the 68-inch pilot parachute. When the reefed G-12 parachute is used with the quadruple A-22 it can support suspended weights from 3,375 to 4,375 pounds. The reefed G-12 and 68-inch pilot parachutes are packed according to Chapter 1, Section II, Paragraphs 1-3 through 1-5 of this manual.

PACKING THE REEFED G-12 AND 68-INCH DIAMETER PILOT PARACHUTES

1-3. The packing procedures for the reefed G-12 parachute are described below.

a. PREPARING PARACHUTE FOR PROPER LAYOUT. Prepare parachute for proper layout in accordance with TM 10-1670-281-23&P.

b. SERVICING THE CANOPY VENT. Service the canopy vent in accordance with TM 10-1670-281-23&P. The wrap of type II cotton muslin cloth is not necessary if dropping for one-time use. If not used, the canopy vent lines should still be tied off with two turns single of 1/4-inch, type I cotton webbing.

c. REEFING THE CANOPY VENT. Remove the bridle loop from the stationary post. With a sharp rigging knife, cut a small slit (approximately 1-1/2-inches in length) in the gore material of every fourth gore, directly below the upper lateral band, as shown in Figure 1-1.

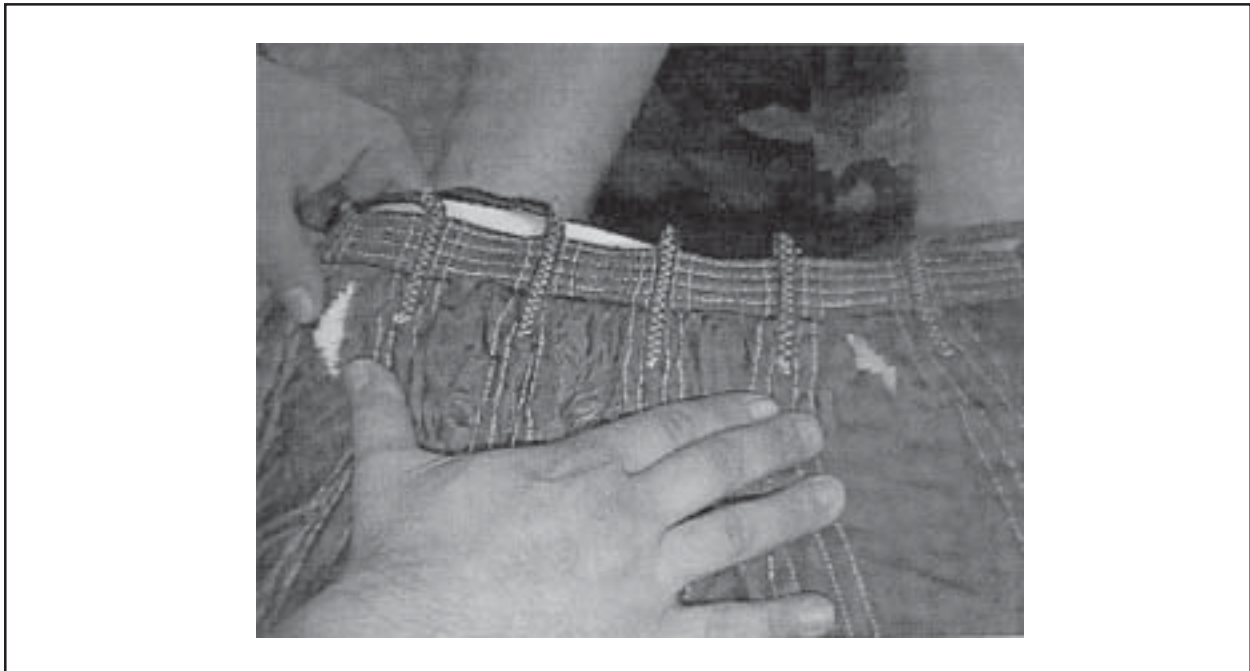

Figure 1-1. Gore Holes Cut Below Upper Lateral Band

- (1)** Route a 4 foot long vent reefing line made of 1- inch tubular nylon from the outside of the gore into the first gore hole as shown in Figure 1-2. Alternate material for the vent reefing line is 1-23/32- inch wide, type VIII nylon webbing or one turn triple of 9/16-inch tubular nylon.

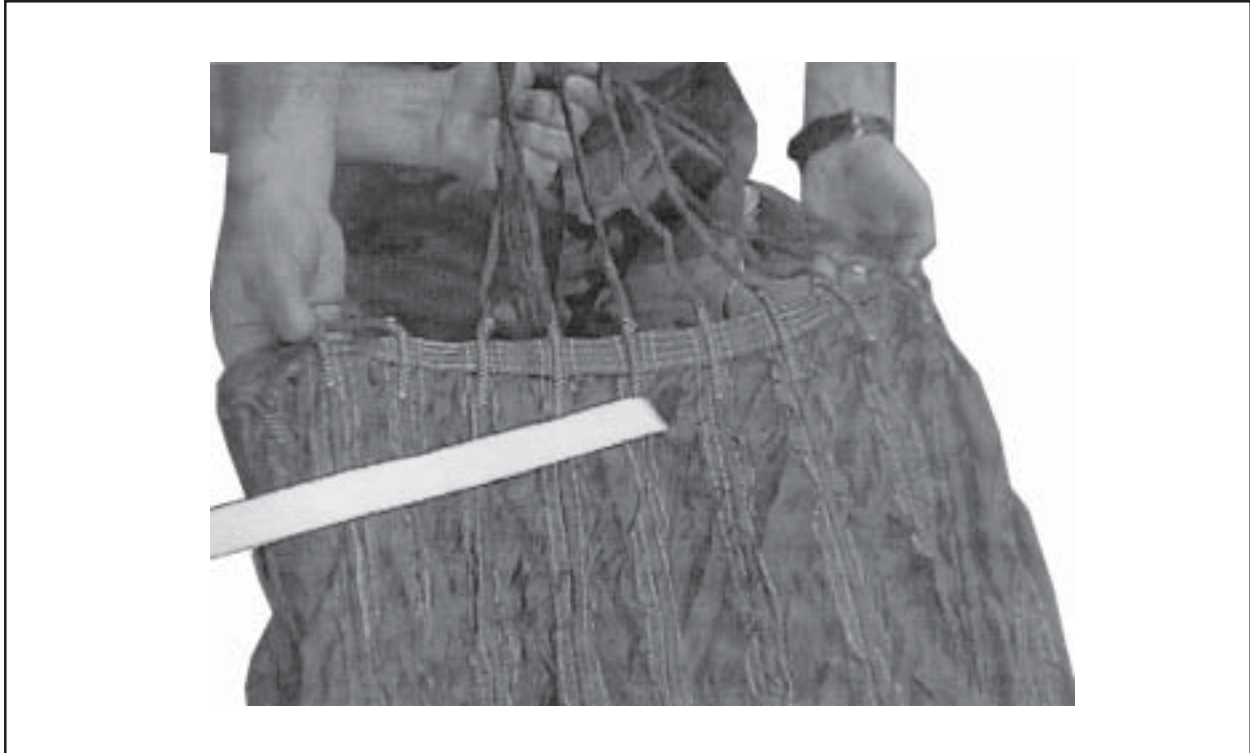

Figure 1-2. Vent Reefing Line Routed into First Gore Hole

- (2) Run the line to the right, over the upper lateral band and down into the next gore hole as shown in Figure 1-3. Follow Figure 1-1 for cutting gore holes every fourth gore. Repeat this procedure until the vent reefing line has run through all 16 gore holes.

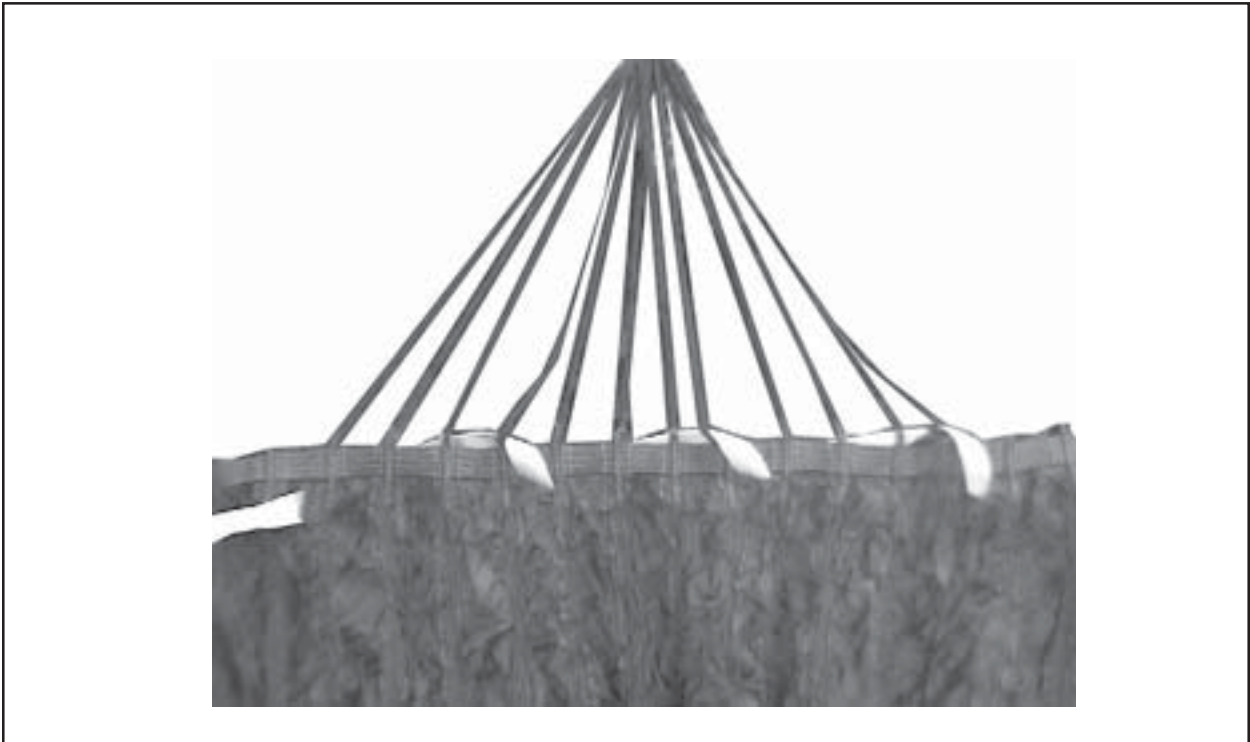

Figure 1-3. Vent Reefing Line Routed Around Upper Lateral Band

- (3)** Pull the vent reefing line tight to close off the vent. Tie the two running ends of the vent reefing line together with a surgeon's knot and locking knot, and overhand knots in the running ends. Trim each running end at a point 2-inches from the surgeon's knot and locking knot as shown in Figure 1-4.



Figure 1-4. Vent Reefing Line Pulled Tight and Tied Off

APPLYING TENSION

1-4. Apply tension in accordance with TM 10-1670-281-23&P.

FOLDING THE GORES AND REEFING THE CANOPY SKIRT

1-5. Position the large line separator, throw the right suspension line group over the left group of gores and lines, and position the large pedestal fan in accordance with TM 10-1670-281-23&P.

a. Lay out a single 47-foot length of 9/16-inch tubular nylon webbing or a doubled 47-foot length of 1/2-inch tubular nylon webbing. Remove twists and apply a small amount of tension (just enough to remove slack). While under tension, measure 2 feet in from both ends and mark the tubular nylon. Fold the webbing length back onto itself and line up the marks. While holding the marks together, pull the line out straight, apply a small amount of tension, and locate and mark the center of the line. This tubular nylon length will be the skirt reefing line.

Note: When fabricating the skirt reefing lines in large quantities, recommend marks on the floor or on a packing table be made at 2 feet, 23-1/2 feet, 45 feet and 47 feet. Use these marks to assist in marking and cutting reefing lines. All measurements should be within ± 1 inch.

b. Route one free running end of the skirt reefing line down through the right side of the suspension line 33 pocket band, behind suspension line 33, and back up through the left side of the pocket band. Pull the line through until the center mark on the skirt reefing line is lined up with suspension line 33 as shown in Figure 1-5. Tie a temporary slip knot in the reefing line onto suspension line 33 to keep the reefing line from moving off the mark.

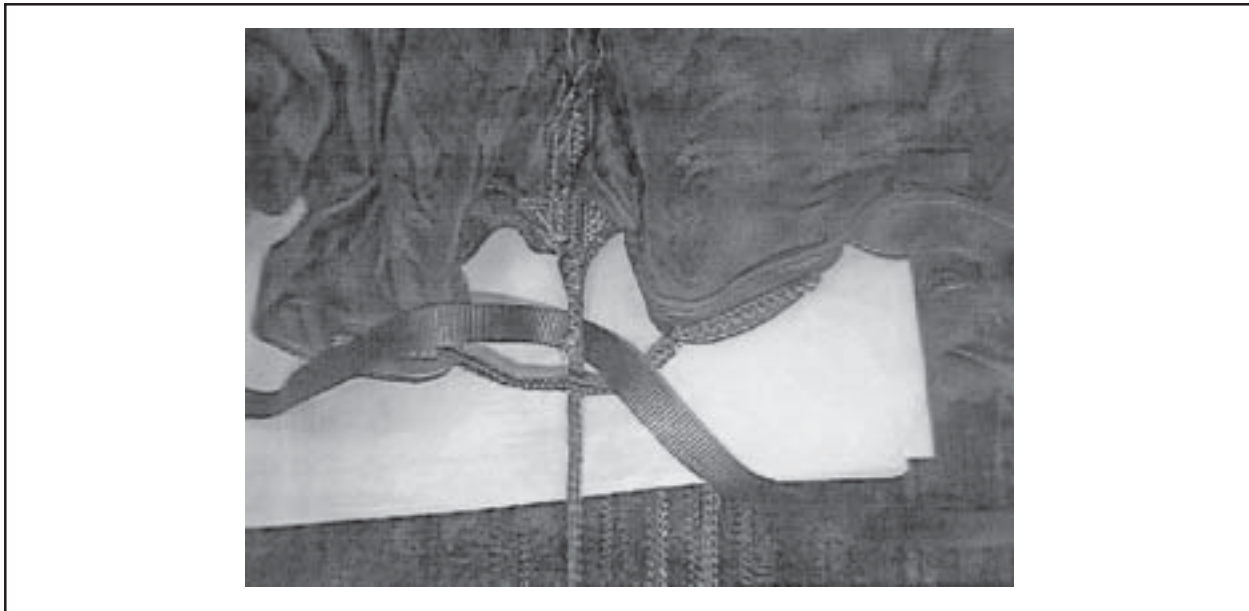

Figure 1-5. Skirt Reefing Line Routed and Centered on Suspension Line 33

c. Begin to fold the right gore group (lines 33 through 64) in accordance with the TM procedures. As each suspension line is passed over, route the reefing line through the pocket band, behind the suspension line and back up through the pocket band of the suspension line being passed over in the same manner as shown in Figure 1-5. Repeat for every suspension line, leaving about 8 inches of slack in the reefing line between each suspension line. Tie a temporary slip knot in the end of the skirt reefing line onto suspension line 64 to keep the reefing line from slipping out of position.

d. Throw the left group of gores over the folded right group of gores. Untie the temporary slip knot in the reefing line on suspension line 33. Fold the left gore group (lines 32 through 1) in accordance with the TM and route the other end of the reefing line through pocket bands 32 through 2 and behind suspension lines 32 through 2 in the same manner as lines 33 through 64.

e. Untie the temporary slip knot in the reefing line on suspension line 64. Run both ends of the reefing line down through pocket band 1 and behind suspension line 1. Line up both marks on the reefing line directly behind suspension line 1. Wrap each end of the reefing line around suspension line 1 one time as shown in Figure 1-6. Tie the ends of the reefing lines together with a surgeon's knot and locking knot and overhand knot in the running ends. Trim each running end at a point 2-inches from the surgeon's knot and locking knot. The skirt reefing is now complete. Complete gore folding in accordance with TM 10-1670-281-23&P.

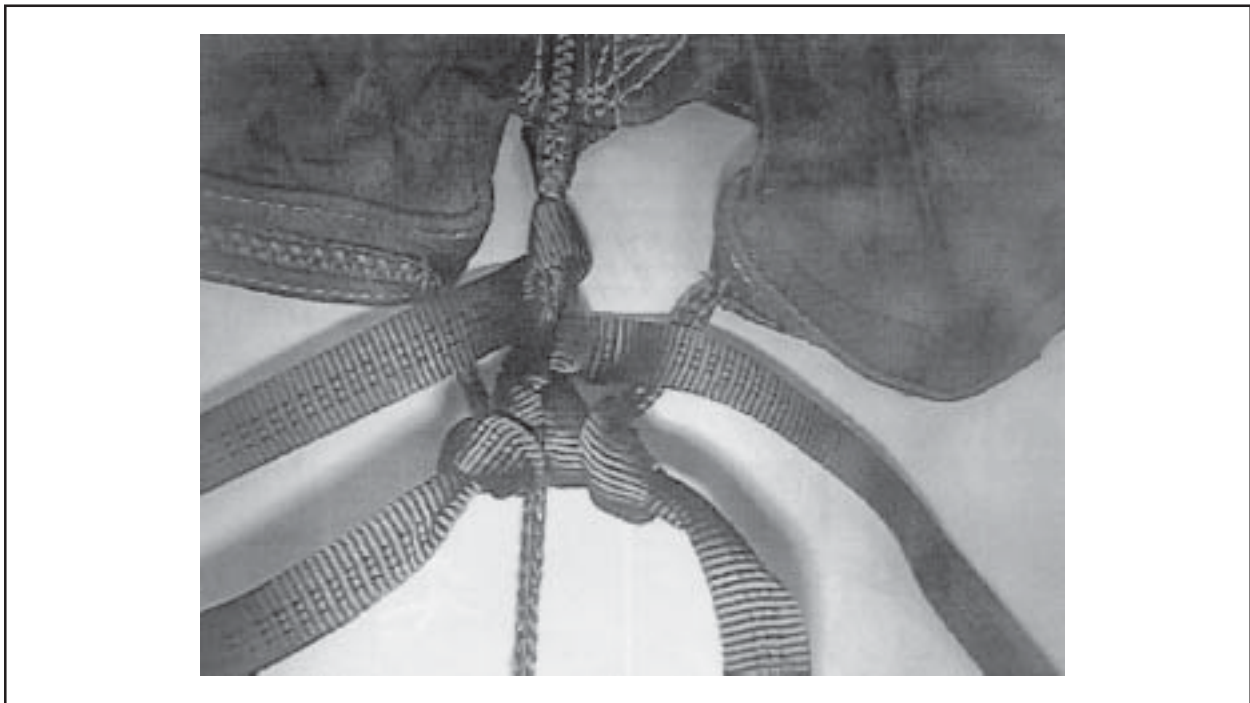

Figure 1-6. Ends of Skirt Reefing Line Wrapped Around and Tied Off at Suspension Line 1

f. Complete Packing of the Reefed G-12. Tie the canopy and suspension lines and tie the connector link assemblies. The break cord tie will be IAW the instructions in Paragraph f (1). Stow the canopy, suspension lines and risers, and close the deployment bag in accordance with TM 10-1670-281-23&P.

(1) Connect the G-12 deployment bag bridle to the parachute apex loop with a 60-inch strap as shown in Figure 1-7. This is necessary to keep the 68-inch pilot parachute permanently attached to the apex of the canopy. Permanently attaching the pilot chute will stabilize the canopy inflation. The following alternate materials are authorized for use for the 60-inch strap:

- (a) A 60-inch loop, single turn of Type VIII nylon webbing
- (b) A 60-inch loop, single turn of 1-inch tubular nylon webbing
- (c) A 60-inch loop, single turn of $\frac{3}{4}$ -inch tubular nylon webbing
- (d) A 60-inch loop, one turn double, of $\frac{9}{16}$ -inch tubular nylon webbing
- (e) The standard 60-inch connector strap, without using L-bar connector links.

NOTE: When installing the 60-inch connector strap without using the L-bar connector links, use the same materials and number of turns shown above to connect one end of the strap to the bag bridle and one end to the apex loop. Use the length required to tie the strap, leaving no slack between the strap and bridle, or the strap and the apex loop.

(2) The ties defined in the above paragraph must be tied at the bag bridle center loop as follows: Run the material through the apex loop, pass the running ends through the top of the deployment bag and then through the bag bridle center loop from opposite directions. Tie the first part of a surgeon's knot inside the center loop, then tie two double overhand knots on the outside of the center loop with knots in the running ends. Tape the 60-inch loop at the apex loop and the bag bridle center loop using several turns of cloth duct tape. When tying the 60-inch connector strap without using the L-Bar connector links, use the same tie as described at both the apex loop and the bag bridle center loop.



Figure 1-7. 60-inch Strap Connecting G-12 Deployment Bag to Parachute Apex Loop Completed

g. Packing and Rigging the 68-inch Diameter Pilot Parachute. Pack and rig the 68-inch pilot parachute for breakaway in accordance with TM 10-1670-281-23&P, except the static line breakcord tie will be made as follows: Cut a 24-inch length of 1/4-inch wide type I cotton webbing (in lieu of the standard type III nylon). Center the length of cotton webbing through the clevis and insure the running ends are aligned. Pass each running end of the cotton webbing through the static line attaching loop from opposite directions forming a 4-inch loop of one turn double between the clevis pin and the attaching loop as shown in Figure 1-8. Secure the cotton webbing ends on top of the static line attaching loop with a surgeon's knot and a locking knot. Trim each running end at a point 2 inches from the surgeon's knot and locking knot.

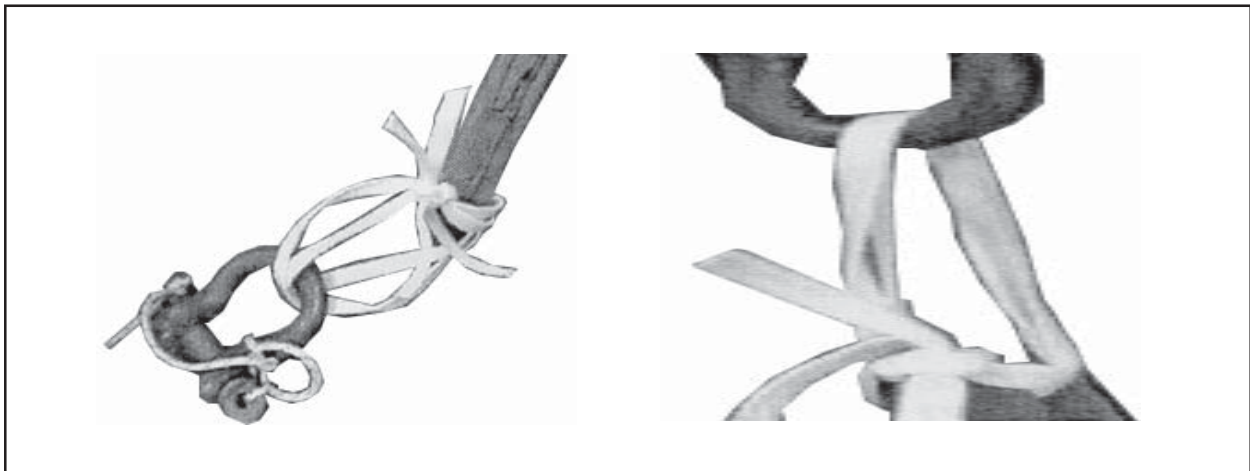

Figure 1-8. Breakaway Static Line Breakcord Tie for 68-inch Diameter Pilot Parachute Secured

POSITIONING PILOT PARACHUTE

1-6. Place the packed pilot parachute on top of the G-12 deployment bag bridle assembly. Use a single loop of ticket number 8/7 cotton thread to secure the pilot parachute onto the reefed G-12 parachute in two places. The first loop of ticket number 8/7 cotton thread will be routed through the pilot parachute D-bag tie-down loops on one side of the pilot parachute D-bag and through the same two tie-down loops on one side of the G-12 bag that are normally used to tie the pilot D-bag. The other loop will be secured in the same manner on the opposite side as shown in Figure 1-9.

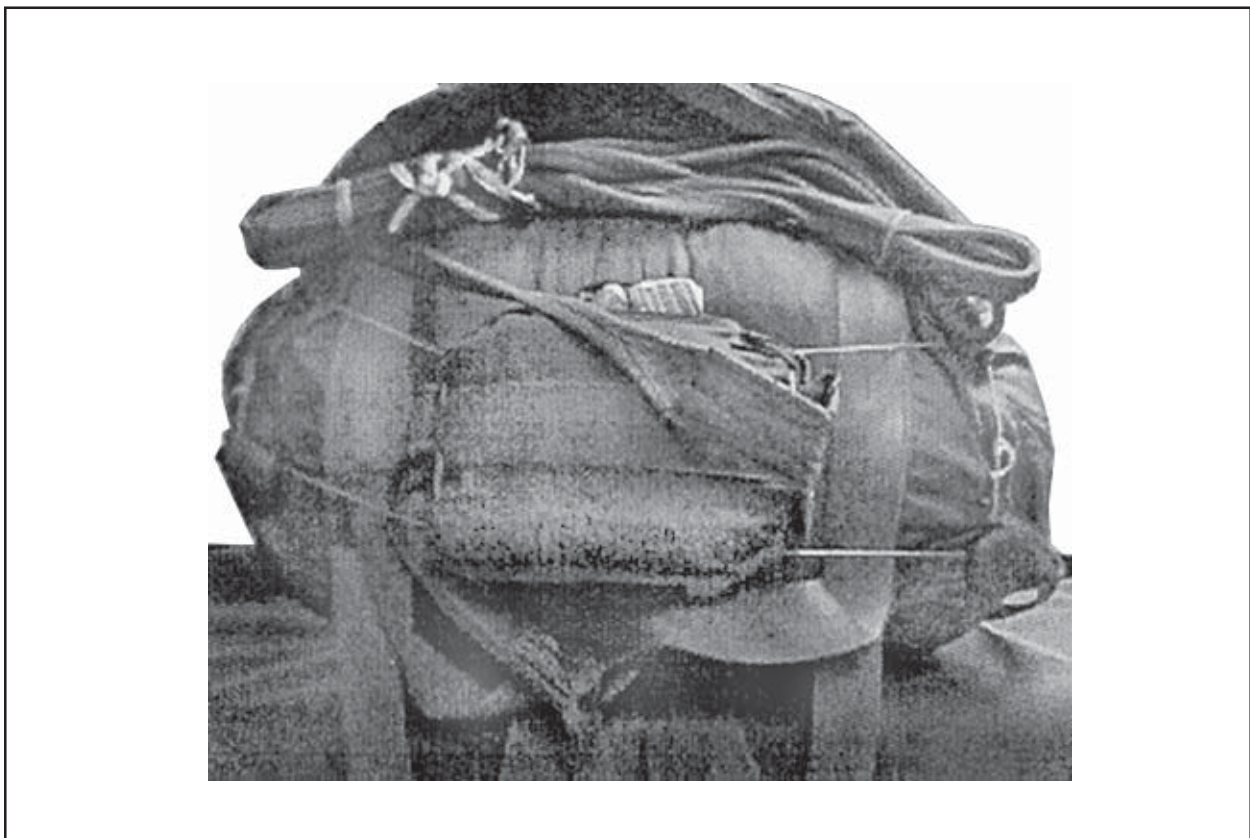

Figure 1-9. 68-inch Diameter Pilot Parachute Secured to G-12 Deployment Bag

Chapter 2

Rigging Extended Tri-Wall Aerial Delivery System (TRIADS)

SECTION I - GENERAL RIGGING INFORMATION FOR EXTENDED TRIADS

TRIAD SYSTEM COMPONENTS

2-1. The TRIAD system, shown in Figure 2-1, is constructed from corrugated tri-wall cardboard. An 80-inch tall sleeve is enclosed by two 12-inch tall end caps. A vertical strap with break cord secures the load for transport. The static line, rigged to the break cord, releases the end caps after deployment from the aircraft permitting the contents of the load to free-fall to the ground.

TRIADS SKID BOARD

2-2. The skid board is made of 1/4- by 48- by 40-inch plywood. If 1/4-inch plywood is not available, 3/16 or 5/16-inch plywood may be substituted. The skid board will be secured to the container using glue and 1-inch staples.



Figure 2-1. Fully Rigged TRIAD System with Gate Suspension Loops

TRIADS CONTAINER LIMITATIONS

2-3. The TRIADS container has a weight restriction of 747 to 1375 pounds. Ensure that the load weighs a minimum of 28 pounds per square foot IAW FM 10-500-3/TO 13C7-1-11.

CAUTION

When dropping MREs or HDRs the maximum load is dependant on drop altitude. Refer to Table 2-1 for the system capacity.

ASSEMBLY LINE RIGGING

2-4. When assembly line rigging is used for TRIADS loads, six stations are needed. The stations are: preparing the caps, preparing honeycomb and skid board, assembly, filling container, strap and static line installation, and final inspection.

INSPECTION OF LOAD

2-5. The TRIADS load must be inspected by a qualified rigger. While being rigged this load should be supervised or rigged by a parachute rigger. DD Form 1748-1 must be completed before airdrop.

PARACHUTE USED

2-6. No parachute is used for this system.

AFT RESTRAINT

2-7. Release gate suspension loops and additional honeycomb kits are required for TRIADS containers at pre-determined release gate locations in the aircraft. Prepare the honeycomb and straps as shown in Figure 2-6.

NOTE: Installation of the release gate suspension loops and the honeycomb kit must be completed prior to filling the container with MREs or HDRs.

SECTION II - RIGGING EXTENDED TRIADS CONTAINERS

SYSTEM DESCRIPTION

2-8. The TRIAD System is a corrugated tri-wall box rigged for static line deployment off the ramp of an aircraft. Typical loads include loose MREs or HDRs. Following deployment, the caps of the box separate from the sleeve allowing the container's contents to scatter and free-fall to the ground.

PREPARING ITEMS AND SKID BOARD

2-9. Refer to Paragraph 2-2 for preparation of the skid board. HDRs or MREs must be removed from their shipping containers before loading.

PREPARING HONEYCOMB BASE

2-10. Prepare the honeycomb base as shown in Figure 2-2. The honeycomb layers will be glued together however, they will not be glued to the base cap.

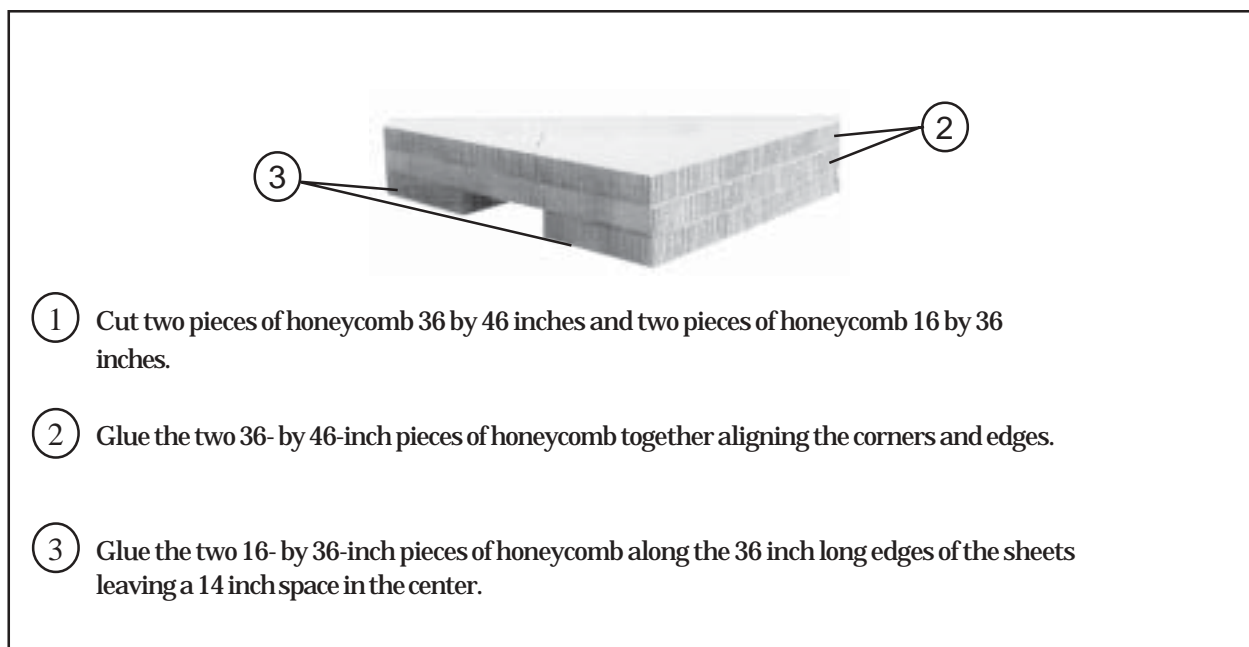

Figure 2-2. Honeycomb Base Prepared

PREPARING STRAPS AND STATIC LINE

2-11. Prepare the straps and static line as described below.

a. Cut one length of type VIII nylon webbing 288 inches long. Measure 20 inches from both ends and place a mark. Fold the type VIII nylon webbing at the 20 inch marks and place a double overhand knot, forming a 4 inch loop in the ends. Place an overhand knot in the running ends.

b. Cut one length of type III nylon cord, 36 inches long and remove the core threads.

c. Cut one length of 1-inch tubular nylon webbing 228 inches long. Measure 15 inches from one end of the nylon and place a mark. Fold the 1-inch tubular nylon webbing at the mark and tie a double overhand knot to form a 4-inch loop. Tie an overhand knot in the running end. Install a G-14 clevis in the loop. From the opposite end of the 1-inch tubular nylon webbing, measure 24 inches and make a mark.

d. Cut four pieces of type VIII nylon webbing (1/2-tubular nylon webbing may be used as a substitute) 40 inches long.

e. Cut two pieces of 1-inch tubular nylon webbing 36 inches long.

PREPARING END CAPS

2-12. Prepare the end caps as shown in Figure 2-3.

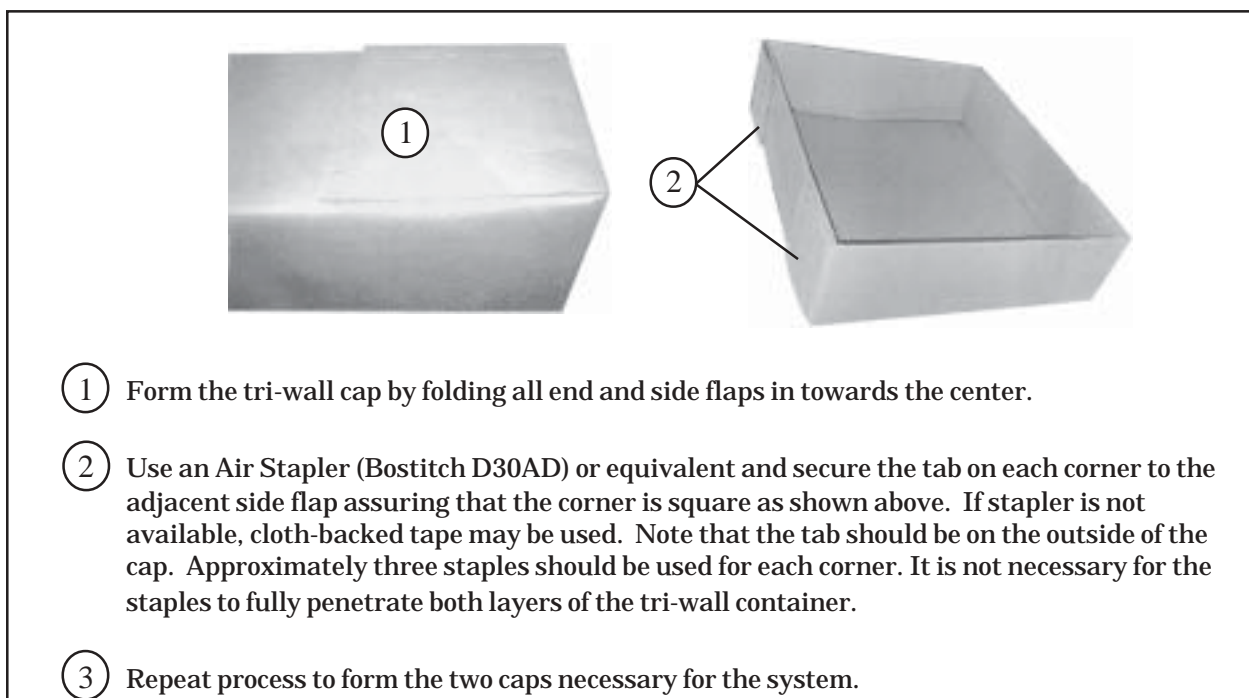

Figure 2-3. End Caps Prepared

INSTALLING SKID BOARD

2-13. Install the skid board on the base cap as shown in Figure 2-4.

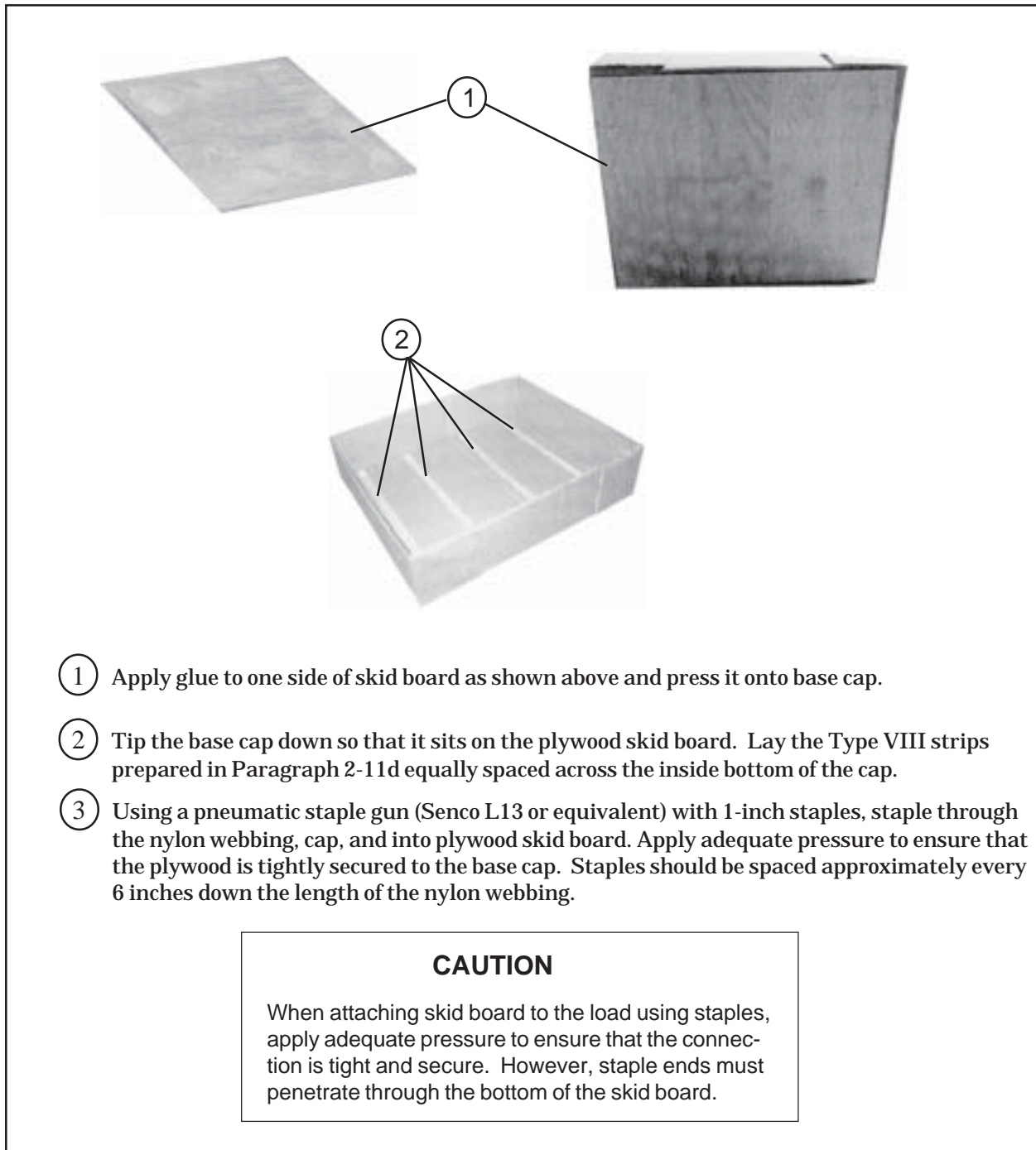

Figure 2-4. Skid Board Attached to Base Cap

ASSEMBLING THE BOX

2-14. Assemble the TRIADS container as shown in Figure 2-5.

GATE SUSPENSION LOOPS AND HONEYCOMB KIT

2-15. TRIADS containers located at release gate locations must have release gate suspension loops installed and honeycomb reinforcement positioned inside the box. Construct and install the release gate suspension loops and honeycomb as shown in Figure 2-6.

FILLING THE TRIADS CONTAINER

2-16. Fill the box with the appropriate weight of HDRs or MREs. Table 2-1 must be used to determine the maximum weight for the drop altitude. Once filled, install the end cap over the top of the sleeve.

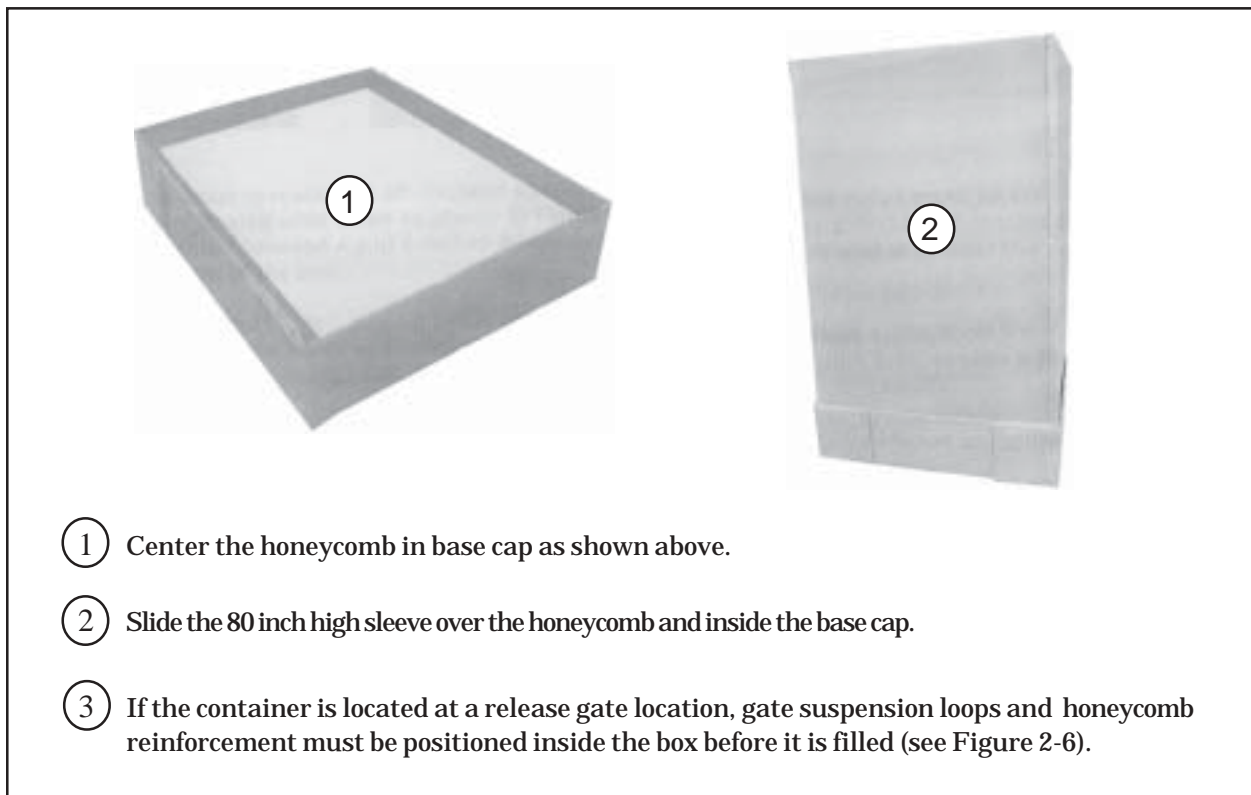

Figure 2-5. TRIADS Container Assembled

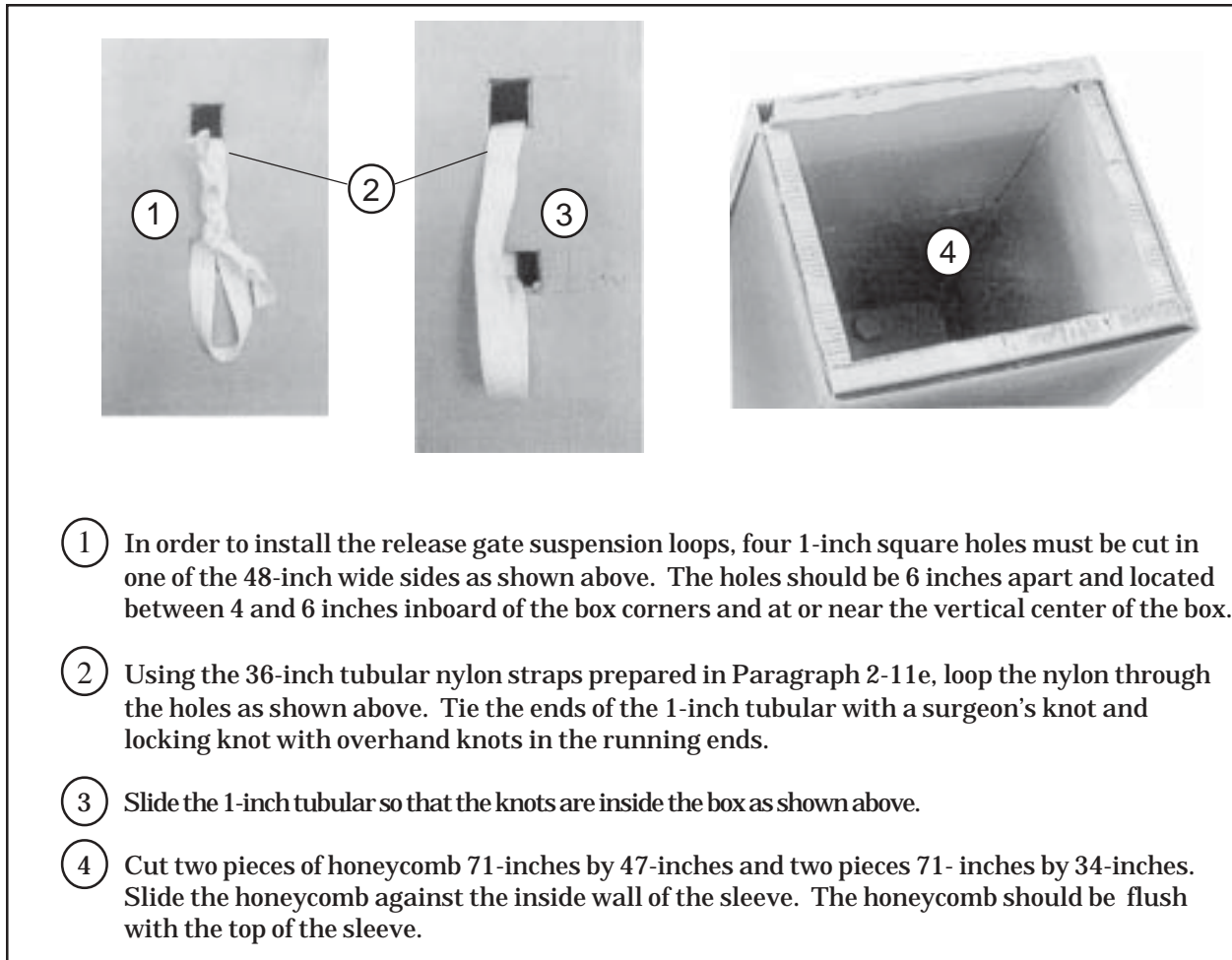

Figure 2-6. Release Gate Suspension Loops and Honeycomb Kit Installed

| Altitude (MSL) | Number of HDR's (cases) | Number of MRE's (cases) | Weight (lb) |
|----------------|-------------------------|-------------------------|-------------|
| 1000 | 610 (61) | 816 (68) | 1373 |
| 15000 | 480 (48) | 648 (54) | 1080 |
| 20000 | 470 (47) | 636 (53) | 1060 |
| 25000 | 470 (47) | 624 (52) | 1060 |
| 30000 | 460 (46) | 612 (51) | 1035 |
| 35000 | 450 (45) | 600 (50) | 1012 |
| 40000 | 440 (44) | 588 (49) | 990 |

Table 2-1. Maximum Fill Capacity for Desired Drop Altitude

INSTALLING VERTICAL STRAP AND STATIC LINE

2-17. Install the vertical strap and static line as shown in Figure 2-7.

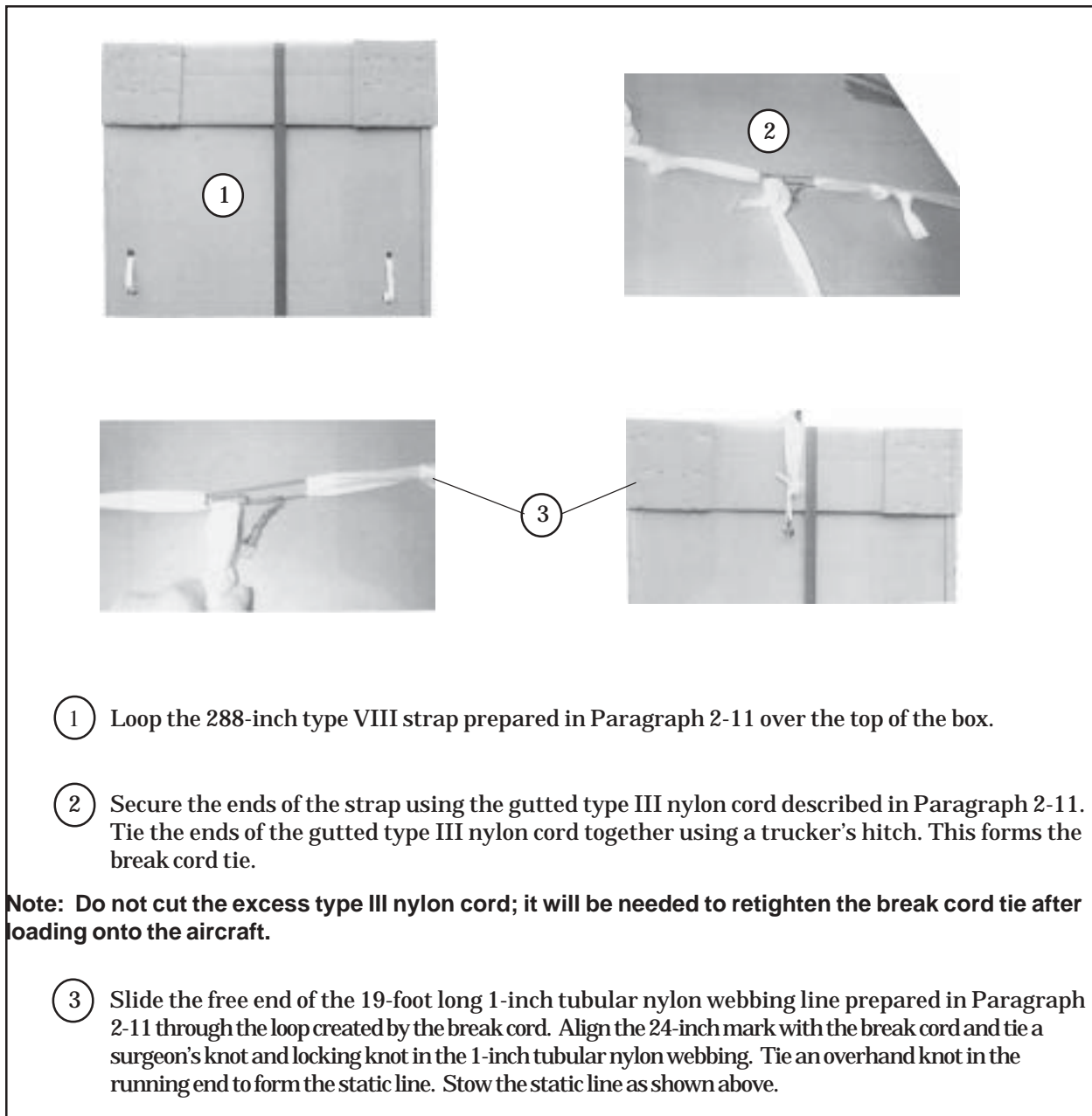



Figure 2-7. Vertical Strap and Static Line Installed

MARKING RIGGED LOAD

2-18. Mark the rigged load according to FM 10-500-3/TO 13C7-1-11 and as shown in Figure 2-8. Compute the rigged load data.

EQUIPMENT REQUIRED

2-19. Use the equipment listed in Table 2-2 to rig the load shown in Figure 2-8.



RIGGED LOAD

| | | |
|---------|----------------------------|--------------|
| Weight: | Minimum load allowed | 747 pounds |
| | Maximum load allowed | 1,375 pounds |
| Height: | | 80 inches |
| Width: | | 42 inches |
| Length: | | 50 inches |

Figure 2-8. Fully Rigged Extended TRIADS

Table 2-1. Equipment Required for Rigging Extended TRIADS

| National Stock Number | Item | Quantity |
|-----------------------|--|-------------|
| No NSN | Tri-Wall Sleeve 40-by 48- by- 80-inch | 1 |
| No NSN | Tri-Wall Cap 40-by 48-by-12-inch | 2 |
| 5530-00-128-5419 | Plywood 1/4-by 48-by-40-inch | 1 |
| No NSN | Senco SLS20-L Narrow Crown Stapler, or equivalent | 1 |
| No NSN | 1-inch Staples, Senco L13, or equivalent | As required |
| No NSN | Bostitch D30AD Air Stapler, or equivalent | 1 |
| No NSN | 1 1/2-inch Staples, Bostitch SW9060, or equivalent | As required |
| 8040-00-273-8713 | Adhesive Paste | As required |
| 1670-00-753-3928 | Pad, energy dissipating, honeycomb 36-by 96- by 3-inches (If TRIADS is positioned in a release gate location, 5 sheets are required) | 1 sheets |
| 4020-00-240-2146 | Cord, nylon type III | 1 Yd |
| 8305-00-263-3591 | Webbing, nylon type VIII | 13 Yds |
| 8305-00-268-2455 | Webbing, tubular nylon, 1-inch | 7 Yds |
| 8305-00-082-5752 | Webbing, tubular nylon, 1/2-in | As required |
| 1607-00-678-8560 | Clevis, small, G-14 | 1 |
| 8305-00-074-5124 | Tape, adhesive, 2-inch | As required |

Chapter 3

Rigging Low Cost Aerial Delivery System (LCADS)

SECTION I - GENERAL INFORMATION FOR LCADS

LCADS SYSTEM COMPONENTS

3-1. The LCADS shown in Figure 3-1 employs a low cost version of the A-22 sling assembly and low cost version of the 26-foot ringslot parachute that can be readily procured if needed. The low cost sling assembly uses a more readily available and more economical material and eliminates much of the hardware as compared to the standard A-22 sling assembly.

LCADS SKID BOARD

3-2. Like the standard high velocity CDS, the sling assembly is secured to a 3/4 or 1- by 48 by 48- inch plywood (Grade AC) skid board with 1/2-inch tubular nylon webbing. Honeycomb is positioned between the container and the skid board for impact cushioning.



Figure 3-1. Fully Rigged LCADS System for High Velocity Airdrop

LCADS CONTAINER LIMITATIONS

3-3. The LCADS container has a weight restriction of 501 to 2,200 pounds. However, it is recommended that the maximum load be limited to 1,750 to insure load survivability.

INSPECTION OF LOAD

3-4. The LCADS load must be inspected by a qualified rigger. While being rigged this load should be supervised or rigged by a parachute rigger. DD Form 1748-1 must be completed before airdrop.

PARACHUTE USED

3-5. LCADS employs a 26-foot HV low cost parachute. The 26-foot low cost parachute performs identically to the standard 26-foot HV parachute except the low cost parachute is designed for one-time use, whereas the standard 26-foot HV is designed for reuse. The low cost parachute may be pre-packed and ready to attach to the load. The standard 26-foot HV parachute may be used if the low cost parachute is not available.

SECTION II- RIGGING HIGH VELOCITY LCADS

SYSTEM DESCRIPTION

3-6. The LCADS System is rigged as a typical A-22 high-velocity load. Typical loads include rations, water, and other small items. LCADS container loads must weigh at least 501 pounds but not exceed 2,200 pounds, excluding the weight of the parachute. The load is rigged with a 26-ft low-cost parachute.

PREPARING ITEMS AND SKID BOARD

3-7. Refer to Figure 3-2 for preparation of the skid board. Prepare the drop items according to the load's sensitivity. Items must be well padded to prevent damage during airdrop.

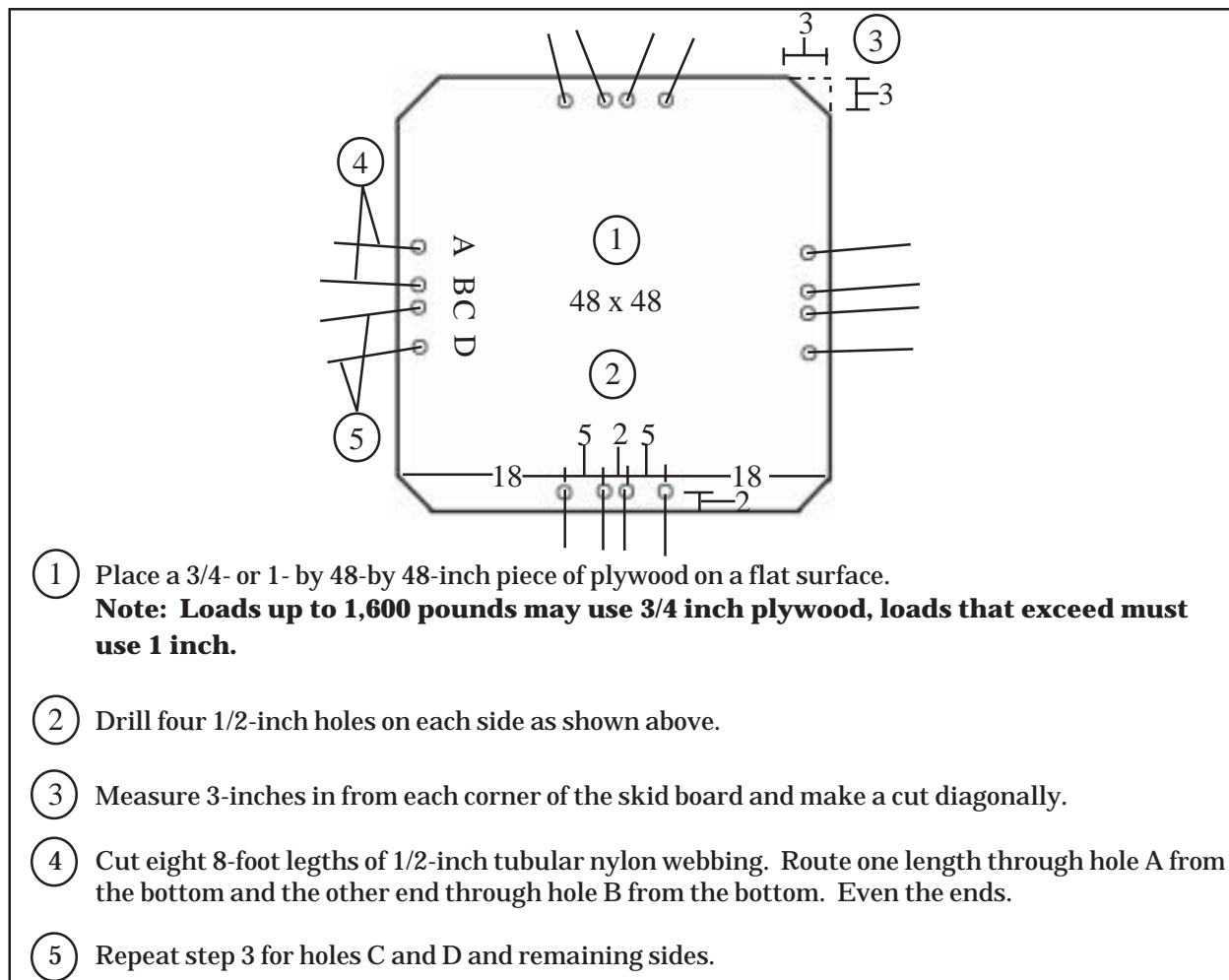
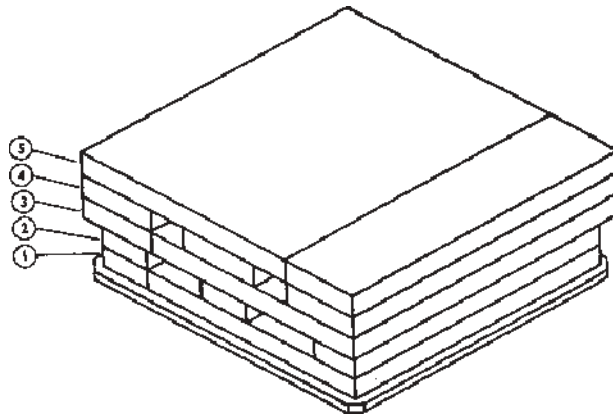

Figure 3-2. Preparing the Skid Board

PREPARING AND PLACING HONEYCOMB

3-8. Prepare and place the honeycomb as shown in Figure 3-3.



- ① Center a 36- by 44-inch and an 8- by 44-inch piece of honeycomb side by side on the skid board. Make sure the layer is 2-inches in from all sides.
- ② Cut three 8- by 44-inch pieces of honeycomb. Center one piece on top of the first layer of honeycomb. Place one piece of honeycomb even with each side edge.
- ③ Center a 36- by 48-inch and an 12- by 48-inch piece of honeycomb side by side on top of the second layer of honeycomb.
- ④ Cut three 12- by 48-inch pieces of honeycomb. Center one piece on top of the third layer of honeycomb. Place one piece of honeycomb even with each side edge.
- ⑤ Repeat step 3 for the fifth layer of honeycomb.

Figure 3-3. Preparing and Placing Honeycomb

POSITIONING SLING ASSEMBLY

3-9. Center the sling assembly over the honeycomb and skid board as shown in Figure 3-4.

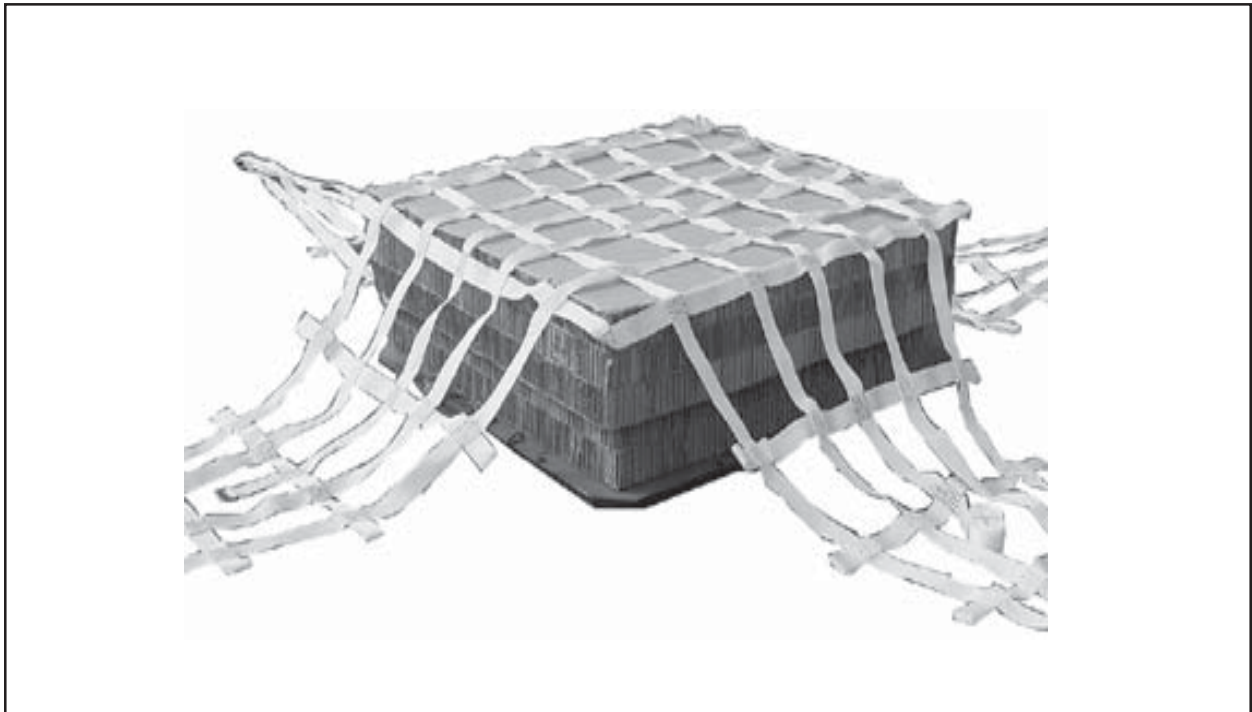

Figure 3-4. Sling Assembly Positioned

POSITIONING LOAD AND SECURING SLING ASSEMBLY

3-10. After centering the load on the sling assembly and honeycomb, cover the load with a plastic bag, shrink wrap or if that is not available, an A-22 cargo cover. Secure and tie sling assembly as shown in Figure 3-5.

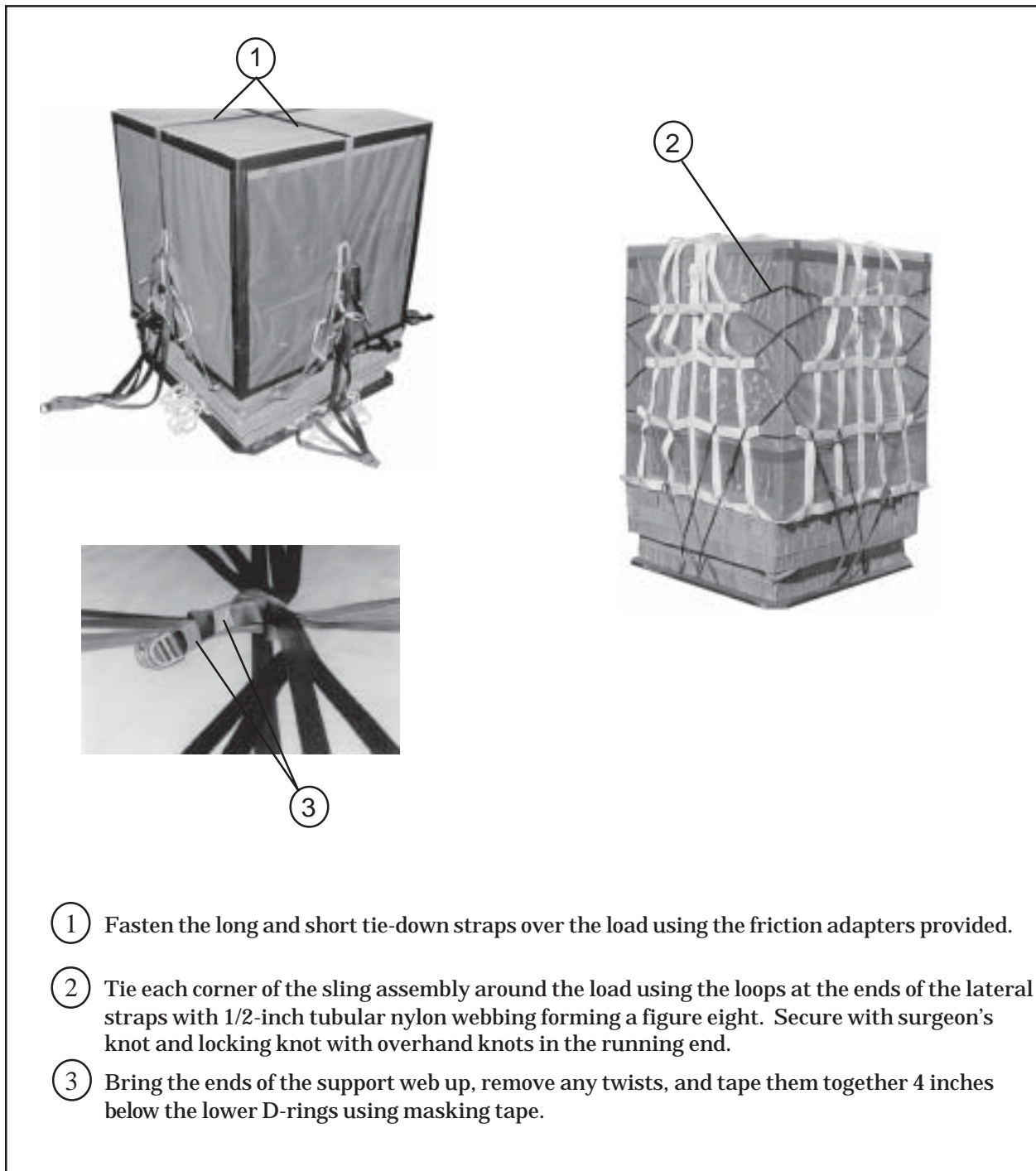

Figure 3-5. Load Positioned and Sling Assembly Secured

SECURING SLING ASSEMBLY TO SKID BOARD

3-11. Tie the sling assembly to the skid board as shown in Figure 3-6.

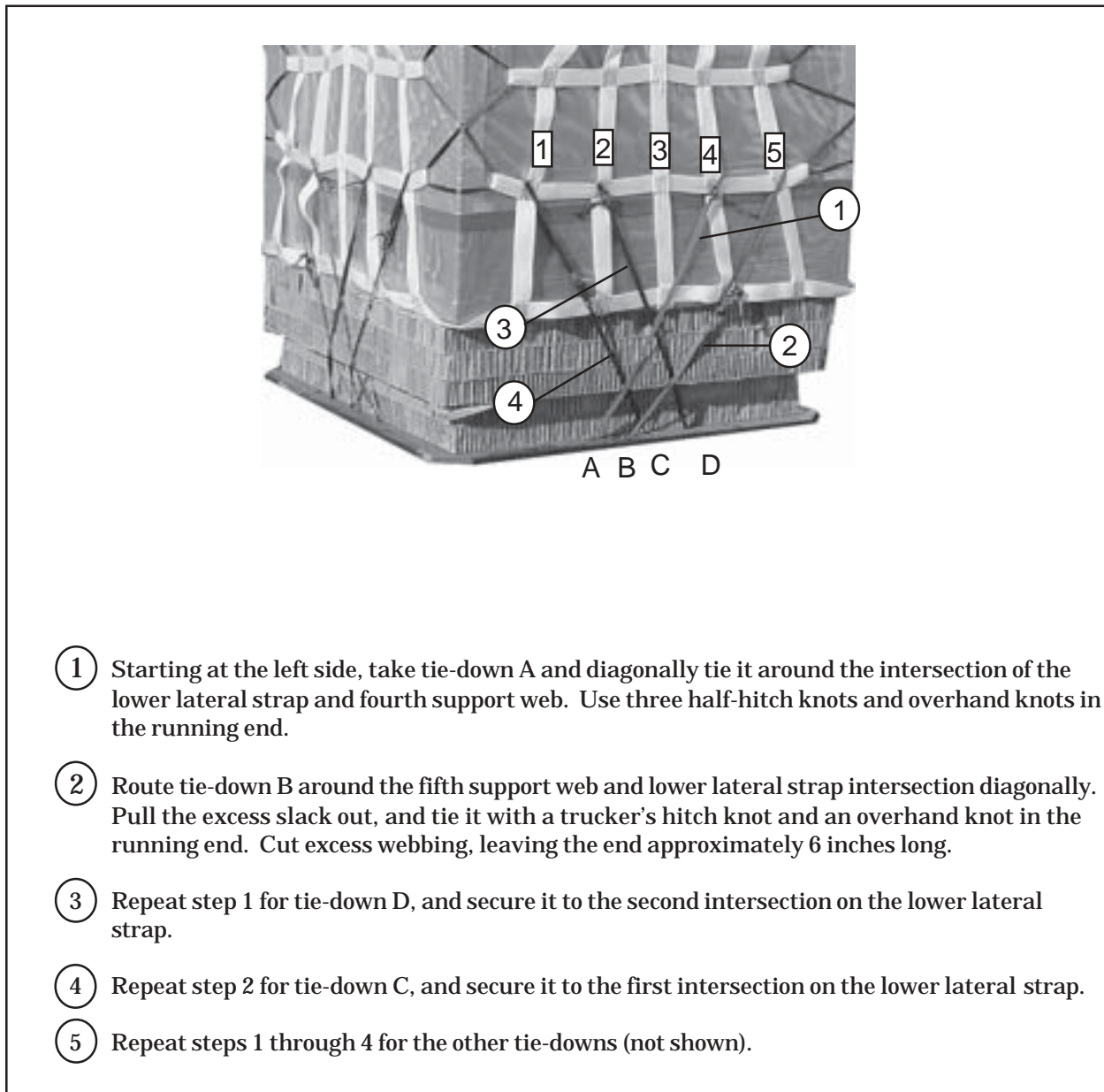

Figure 3-6. Skid Board Secured to Sling Assembly

INSTALLING PARACHUTE

3-12. Install the 26-foot low cost parachute as shown in Figure 3-7.

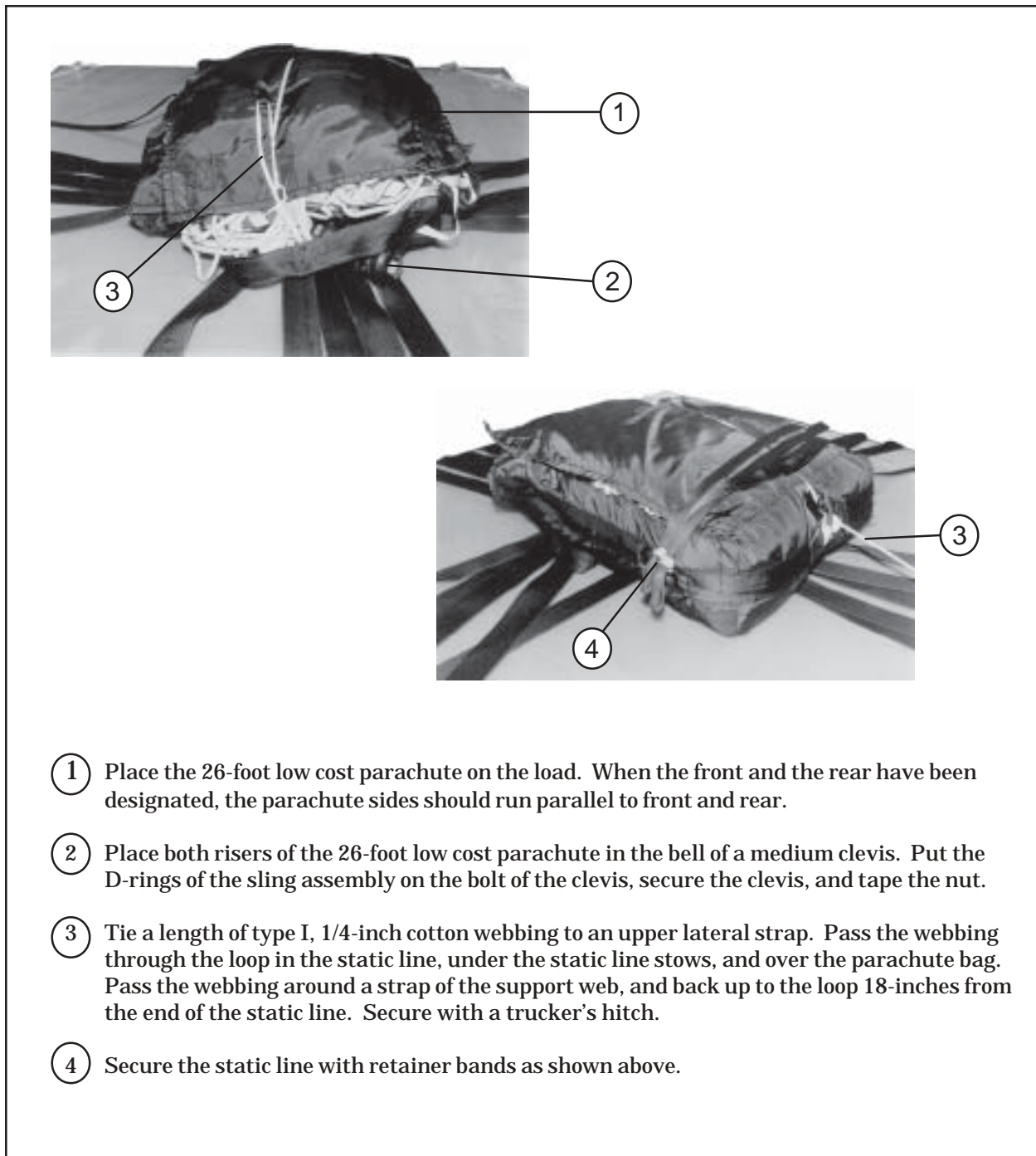



Figure 3-7. 26-foot Low Cost Parachute Installed

MARKING RIGGED LOAD

3-13. Mark the rigged load according to FM 10-500-3/TO 13C7-1-11 and as shown in Figure 3-8. Compute the rigged load data.

EQUIPMENT REQUIRED

3-14. Use the equipment listed in Table 3-1 to rig the load shown in Figure 3-8.



RIGGED LOAD

| | | |
|---------|----------------------------|--------------|
| Weight: | Minimum load allowed | 501 pounds |
| | Maximum load allowed | 2,200 pounds |
| Height: | | 83 inches |
| Width: | | 48 inches |
| Length: | | 48 inches |

Figure 3-8. Fully Rigged LCADS

Table 3-1. Equipment Required for Rigging LCADS

| National Stock Number | Item | Quantity |
|--------------------------------------|--|----------------------------|
| 8040-00-273-8713 | Adhesive Paste | As required |
| | Bag, cover, 4 mil polyethylene (54- by 52- by 60-inches) | As required |
| | Shrink wrap | As required |
| | Sling assembly, LCADS | 1 |
| 4030-00-678-8562 | Clevis, suspension, 3/4-inch (medium) | 1 |
| 4020-00-240-2146 | Cord, nylon type III | As required |
| 1670-00-753-3928 | Pad, energy dissipating, honeycomb 36- by-96- by 3- inches | 3 sheets |
| No NSN | Parachute: cargo, high-velocity, 26-ft, low cost | 1 |
| 5530-00-128-4981 | Plywood, 3/4- by 48- by 96-inch or | 1 sheet |
| 5530-00-914-5118 | Plywood, 1- by 48- by 96-inch | 1 sheet |
| 7510-00-266-6710 | Tape, masking, 2-inch | As required |
| 8310-01-102-4478 | Thread, cotton, ticket number 8/7 | As required |
| 8305-00-268-2411 8305-00-082-5752 | Webbing: Cotton, 1/4-inch, type I Nylon, tubular, 1/2-inch | As required As required |

SECTION III - RIGGING LOW VELOCITY LCADS

SYSTEM DESCRIPTION

3-15. The LCADS is rigged as a typical A-22 low-velocity load. Typical loads include rations, repair parts, water, and/or other small items. Items may be dropped in their original configuration or repackaged for greater protection. The LCADS container loads must weigh at least 501 pounds but not exceed 2,200 pounds excluding the parachute. The load is rigged with a G-12E cargo parachute.

PREPARING ITEMS AND SKID BOARD

3-16. Prepare the skid board using Figure 3-2. Prepare the items to be dropped according to load's sensitivity. Items must be well padded to prevent damage during airdrop.

PREPARING AND PLACING HONEYCOMB

3-17. Prepare and place the honeycomb as shown in Figure 3-9.

NOTE: Glue all honeycomb in-place.

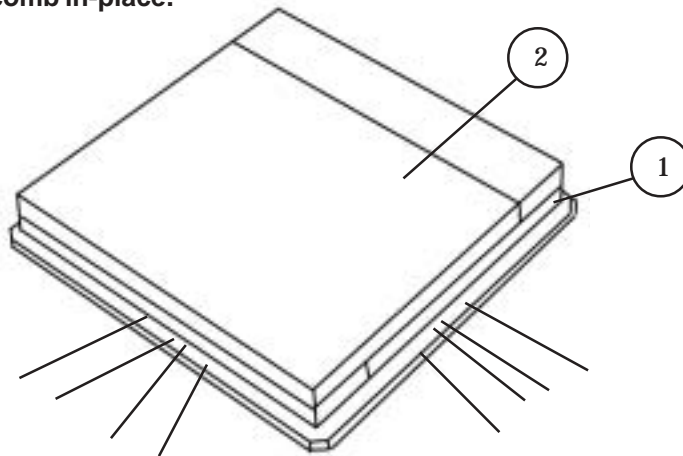

1 Center a 36- by 44-inch and an 8- by 44-inch piece of honeycomb side by side on the skid board. Make sure the layer is 2 inches from all sides.

2 Repeat step 1 for a second layer of honeycomb; alternating the pieces of honeycomb.

Figure 3-9. Honeycomb Placed and Prepared

POSITIONING SLING ASSEMBLY

3-18. Center the sling assembly over the honeycomb and skid board as shown in Figure 3-10. The dimensions of the webbing is 222 by 222 inches.

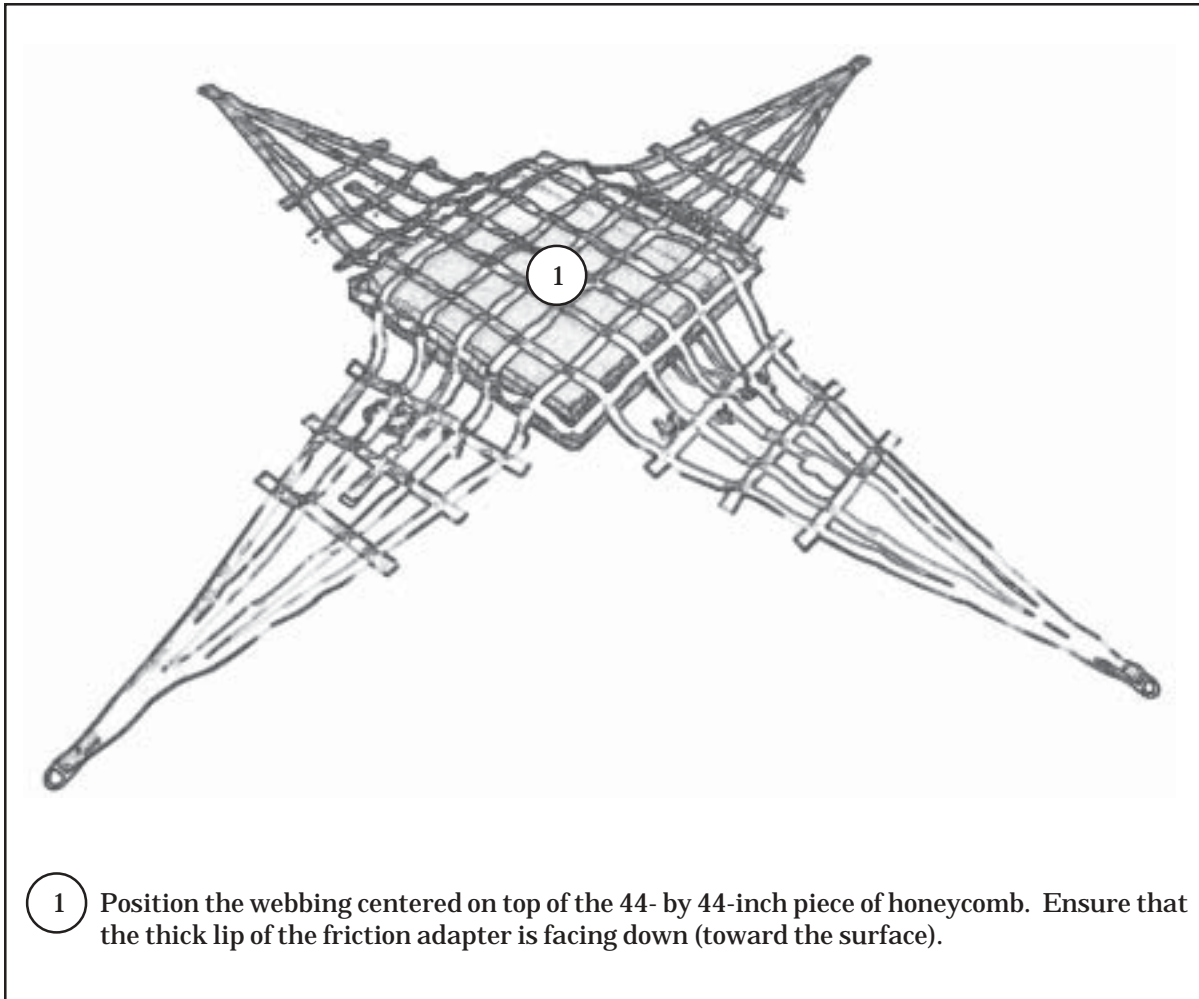

1 Position the webbing centered on top of the 44- by 44-inch piece of honeycomb. Ensure that the thick lip of the friction adapter is facing down (toward the surface).

Figure 3-10. Sling Assembly Positioned

POSITIONING LOAD AND SECURING SLING ASSEMBLY

3-19. Center and secure the load on the sling assembly and honeycomb. If a cover is available, cover the load with a plastic bag, shrink wrap or an A-22 cargo cover. A cover is not required. Secure and tie the sling assembly as shown in Figures 3-5 and 3-11.

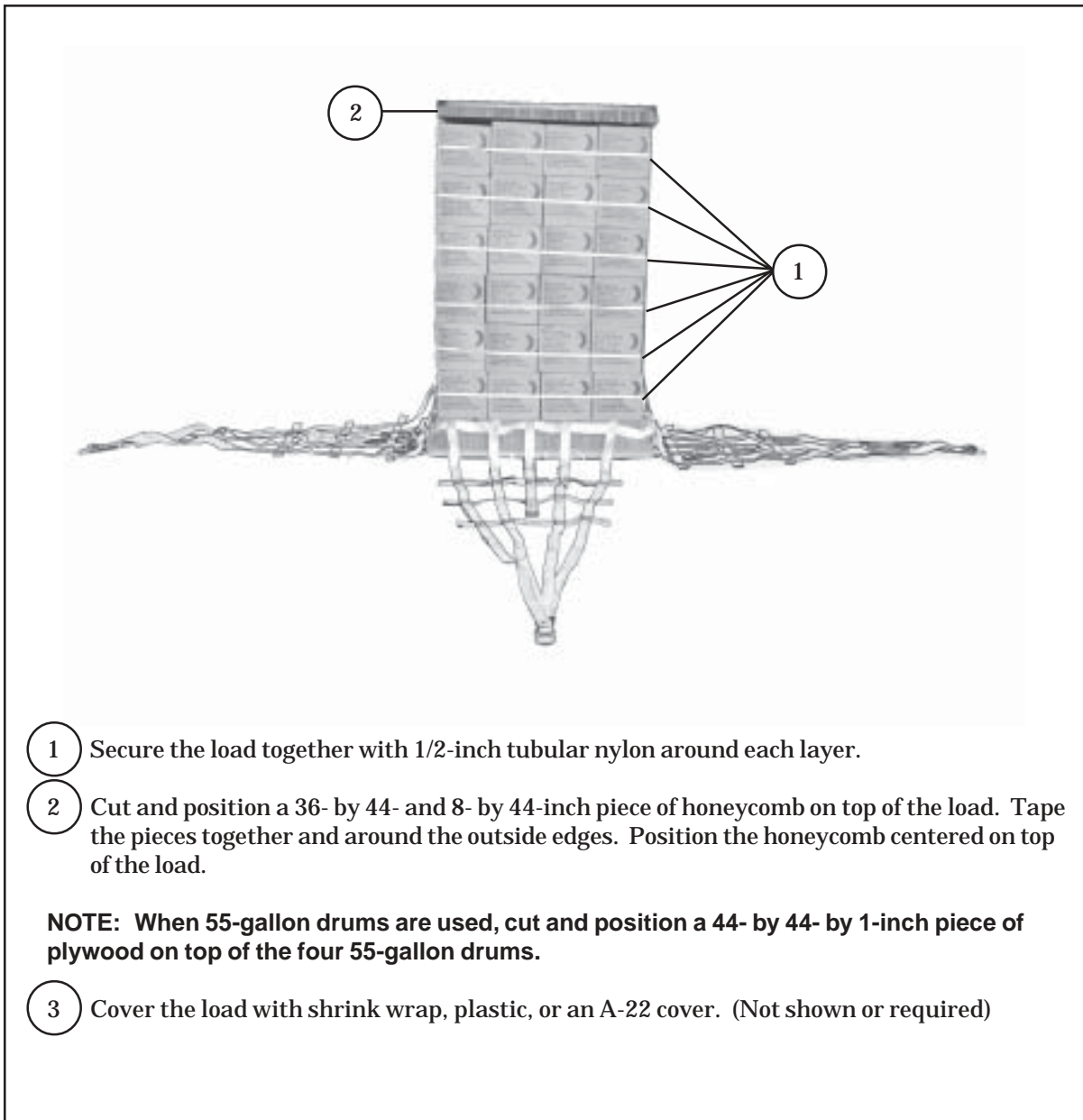

1 Secure the load together with 1/2-inch tubular nylon around each layer.

2 Cut and position a 36- by 44- and 8- by 44-inch piece of honeycomb on top of the load. Tape the pieces together and around the outside edges. Position the honeycomb centered on top of the load.

NOTE: When 55-gallon drums are used, cut and position a 44- by 44- by 1-inch piece of plywood on top of the four 55-gallon drums.

3 Cover the load with shrink wrap, plastic, or an A-22 cover. (Not shown or required)

Figure 3-11. Load Positioned and Sling Secured

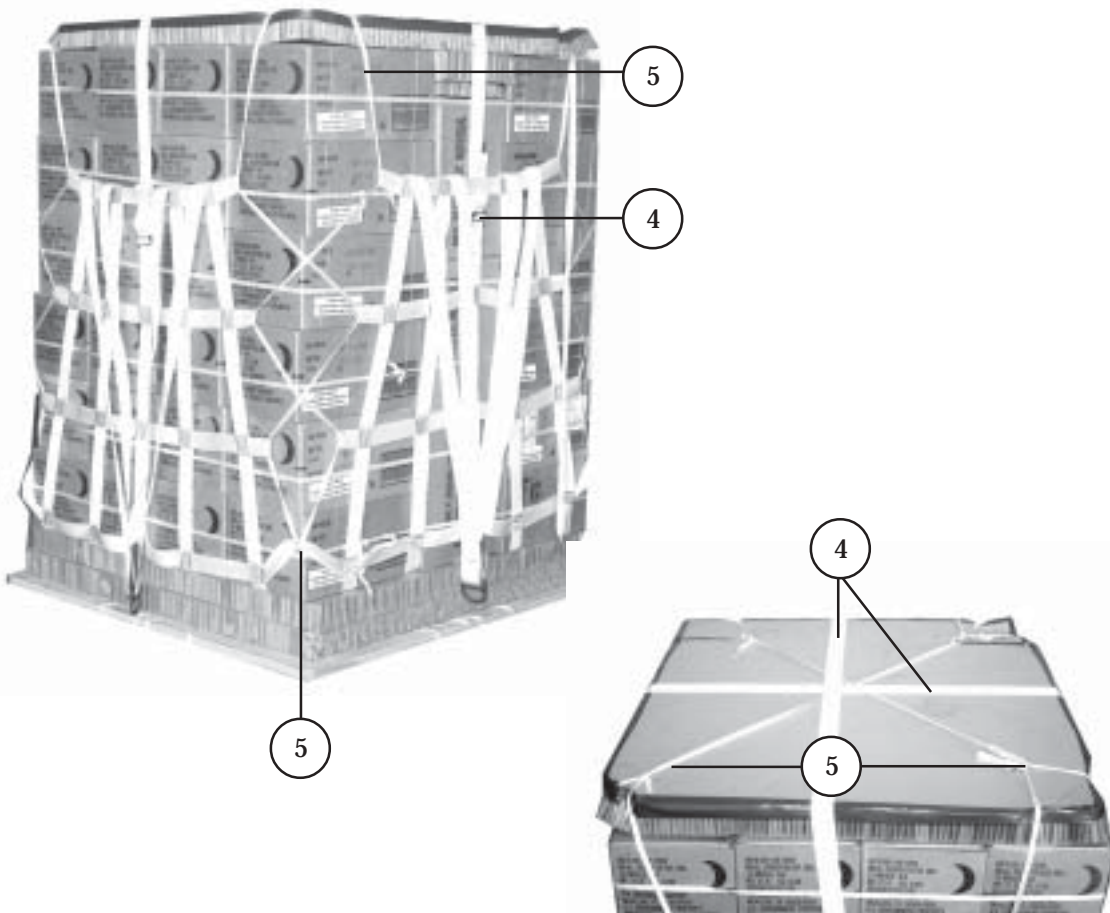

- 4 Fasten the long and short tie-down straps over the load using the friction adapters provided.
- 5 Tie each corner of the sling assembly with 1/2-inch tubular nylon webbing; route the webbing up through the bottom webbing loop, cross the ties, up through the next loops, and repeat until the top loops are reached. Secure the ties together on the top corners with a surgeons knot and locking knot. Secure the excess webbing to the loop of the opposite corner.

NOTE: On a load where the top lateral straps are above the top of the item, secure the loops together as closely as possible with the tie on top.

- 6 Bring the ends of the support web up, remove any twists, and tape them together 4-inches below the D-rings using 2-inch masking tape (not shown).

Figure 3-11. Load Positioned and Sling Secured (Continued)

SECURING SLING ASSEMBLY TO SKID BOARD

3-20. Tie the sling assembly to the skid board as shown in Figure 3-6.

INSTALLING PARACHUTE

3-21. Install the G-12E cargo parachute as shown in Figure 3-12.

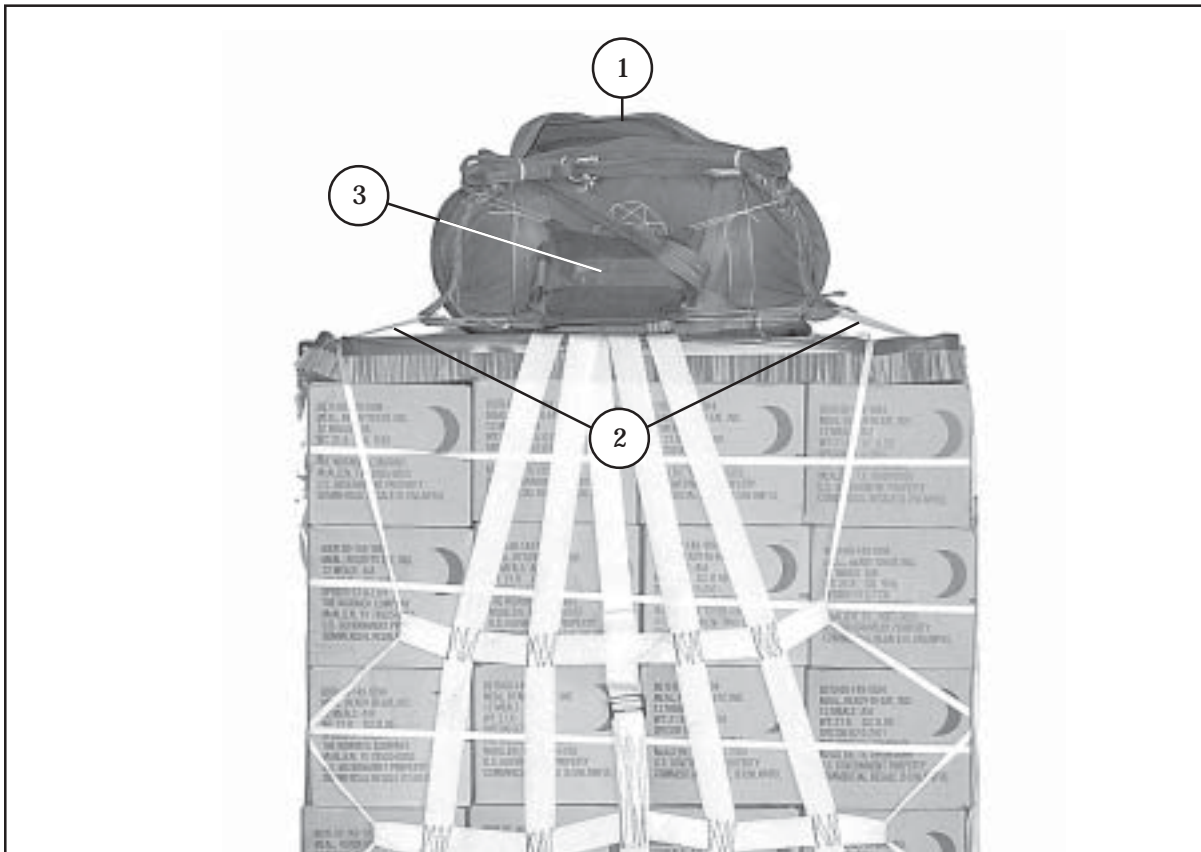

- 1 Position a G-12E cargo parachute on top of the load and secure the parachute clevis to the securing web D-rings.
- 2 Tie the corners of the parachute with one turn single type I, 1/4-inch cotton webbing to the sling assembly.
- 3 Secure the 68-inch pilot parachute to the G-12 deployment bag as described in paragraph 1-6.

Figure 3-12. G-12E Cargo Parachute Installed

MARKING RIGGED LOAD

3-22. Mark the rigged load according to FM 10-500-3/TO 13C7-1-11 and as shown in Figure 3-13. Compute the rigged load data.

EQUIPMENT REQUIRED

3-23. Use the equipment listed in Table 3-2 to rig the load shown in Figure 3-13.

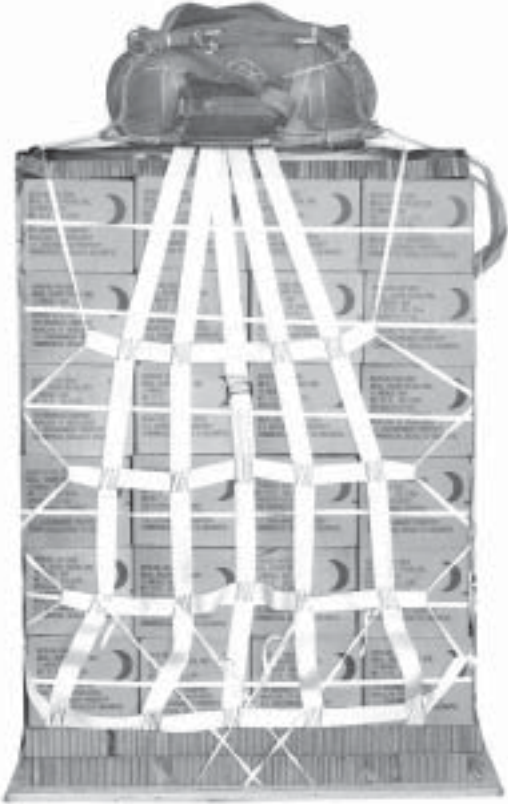

RIGGED LOAD

| | |
|--|--------------|
| Weight: Minimum load allowed | 501 pounds |
| Maximum load allowed (without parachute) | 2,200 pounds |
| Height: | 80 inches |
| Width: | 48 inches |
| Length: | 48 inches |

Figure 3-13. Low-Velocity LCADS Rigged

Table 3-2. Equipment Required for Rigging Low-Velocity LCADS

| National Stock Number | Item | Quantity |
|-----------------------|--|-------------|
| 8040-00-273-8713 | Adhesive Paste | As required |
| | Bag, cover, 4mil polyethylene (54- by 52- by 60-inches) | As required |
| | Shrink wrap | As required |
| | Sling assembly, LCADS | 1 |
| 4030-00-678-8562 | Clevis, suspension, 3/4-inch (medium) | 1 |
| 4020-00-240-2146 | Cord, nylon type III | As required |
| 1670-00-753-3928 | Pad, energy dissipating, honeycomb 36- by 96- by 3- inches | 3 sheets |
| | Parachute: | |
| 1670-00-893-2371 | Cargo, G-12E | 1 |
| 1670-00-216-7297 | Pilot, 68-inch diameter | 1 |
| 5530-00-128-4981 | Plywood, 3/4- by 48- by 96-inch or | 1 sheet |
| 5530-00-914-5118 | Plywood, 1- by 48- by 96-inch or | 1 sheet |
| 1670-01-342-5913 | Skid Board, 1- by 48- by 48-inch or | 1 |
| 1670-00-883-1654 | Skid Board, 3/4- by 48- by 48-inch | 1 |
| 7510-00-266-6710 | Tape, masking, 2-inch | As required |
| 8310-01-102-4475 | Thread, cotton, ticket number 8/7 | As required |
| | Webbing: | |
| 8305-00-268-2411 | Cotton, 1/4-inch, type I | As required |
| 8305-00-082-5752 | Nylon, tubular, 1/2-inch | As required |

Chapter 4

Rigging Double A-22 Container for High Velocity Airdrop

SECTION I - GENERAL INFORMATION FOR DOUBLE A-22 CONTAINER

DOUBLE A-22 CONTAINER COMPONENTS

4-1. The double A-22 container, shown in Figure 4-1, employs two standard A-22 sling assemblies which can be laced together to form a larger container, or which can be individually rigged and configured side-by-side as described in Section III of this chapter. This system employs a reefed G-12 parachute.

DOUBLE A-22 CONTAINER SKID BOARD

4-2. The sling assemblies are secured to a 1- by 48- by 96- inch plywood (Grade AC) skid board with 1/2- inch tubular nylon webbing. Honeycomb is positioned between the container and the skid board for impact cushioning.

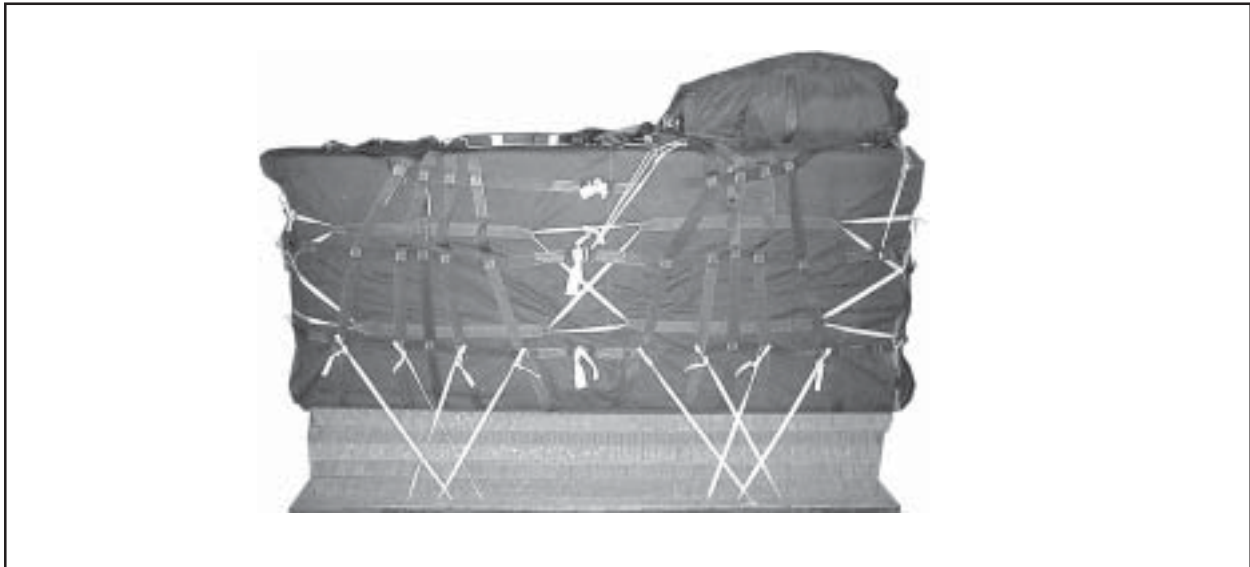

Figure 4-1. Fully Rigged Double A-22 Container System

DOUBLE A-22 CONTAINER LIMITATIONS

4-3. The double A-22 container has a weight restriction of 2,201 to 3,375 pounds. Ensure the load weighs a minimum of 28 pounds per square foot IAW FM 10-500-3/TO 13C7-1-11.

ASSEMBLY LINE RIGGING

4-4. When assembly line rigging is used for double A-22 container loads, five stations are needed. The stations are: laying out containers and preparing base, positioning load, rigging load, installing parachute, and inspecting the rigged load.

INSPECTION OF LOAD

4-5. The double A-22 container load must be inspected by a qualified rigger. While being rigged, this load should be supervised or rigged by a parachute rigger. DD Form 1748-1 must be completed before airdrop.

PARACHUTE USED

4-6. The system employs a reefed G-12 parachute with both skirt and vent reefing. Procedures for packing the reefed G-12 parachute can be found in Chapter 1, Section II of this manual.

SECTION II - RIGGING DOUBLE A-22 CONTAINER

SYSTEM DESCRIPTION

4-7. A typical load is rigged for high-velocity airdrop using a double A-22 container. The double container is made by using two A-22 sling assemblies. Shrink wrap or plastic sheeting can be used in lieu of the standard A-22 cargo cover. Double A-22 cargo bag container loads must weigh at least 2,201 pounds but not exceed 3,375 pounds, excluding the weight of the parachute. The load is rigged with a reefed G-12 parachute.

PREPARING ITEMS AND SKID BOARD

4-8. Prepare the skid board according to Figure 4-2. Prepare the drop items according to the load's sensitivity. Items must be well padded to prevent damage during airdrop.

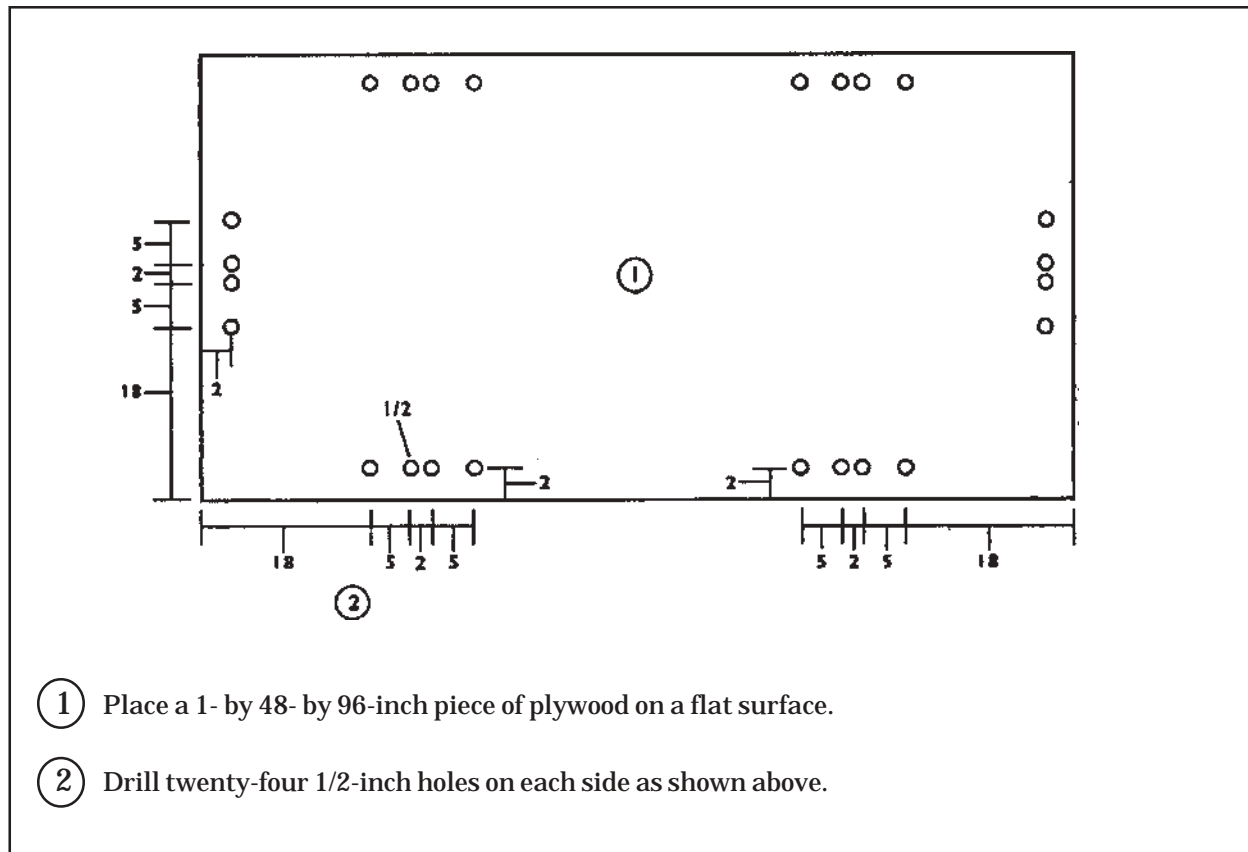

Figure 4-2. Skid Board Prepared

PREPARING SKID BOARD TIES AND PLACING HONEYCOMB

4-9. Prepare the skid board ties and place the honeycomb as shown in Figure 4-3.

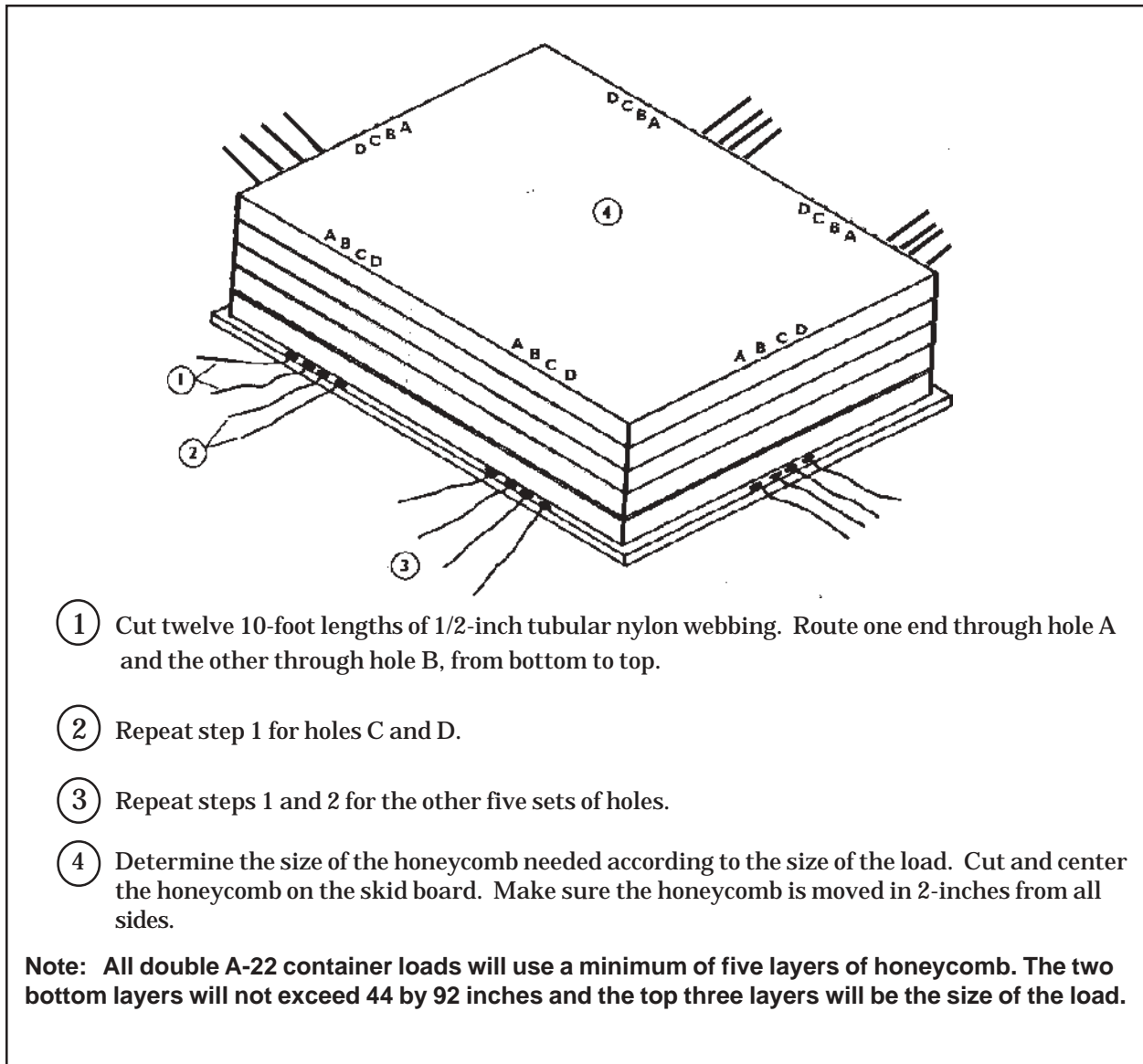

Figure 4-3. Skid Board Ties Prepared and Honeycomb Placed

POSITIONING A-22 SLING ASSEMBLIES

4-10. Position two A-22 sling assemblies on the double A-22 load as shown in Figure 4-4.

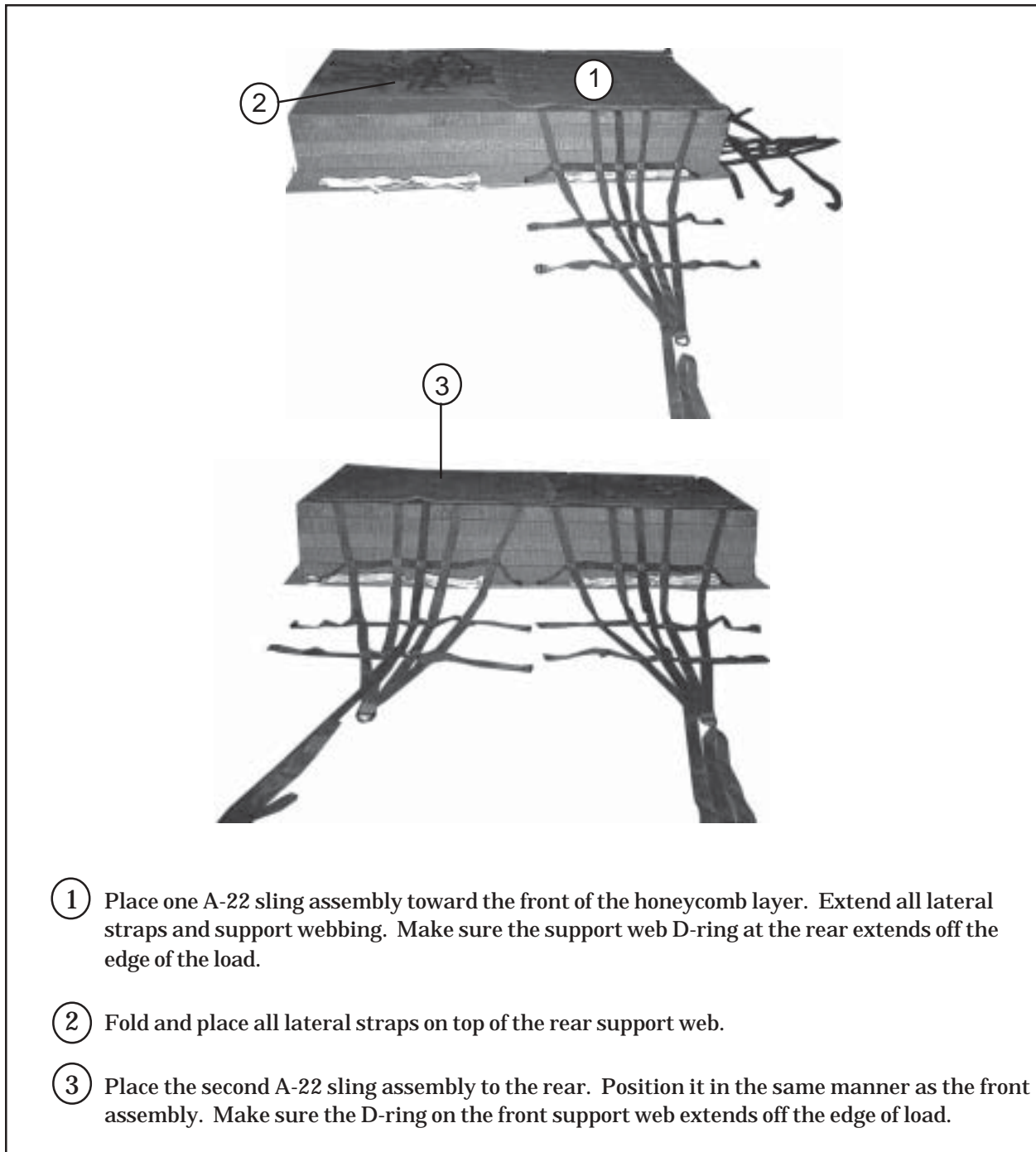
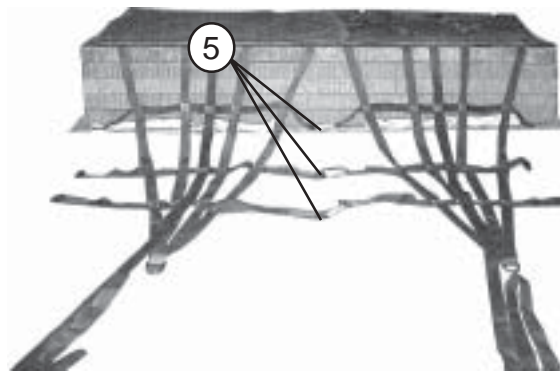
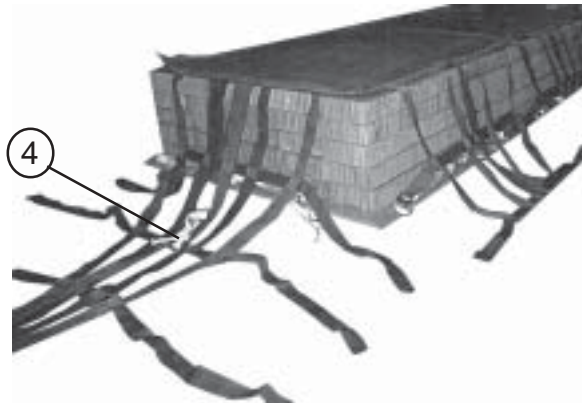

Figure 4-4. A-22 Sling Assemblies Positioned



- ④ Use a length of type VIII nylon webbing to tie the support web D-rings exposed at the front and rear of the load to the other A-22 sling assemblies as shown.
- ⑤ Cut six lengths of type VIII nylon webbing. Route one length through each set of friction adapters at the midsection of the load as shown. Do not apply tension at this time.

Figure 4-4. A-22 Sling Assemblies Positioned (continued)

POSITIONING COVERS AND HONEYCOMB

4-11. Use two A-22 cargo bag covers when rigging this load, if needed. Position the covers as shown in Figure 4-5. Placing an additional layer of honeycomb on top of the covers as shown is recommended but not required.

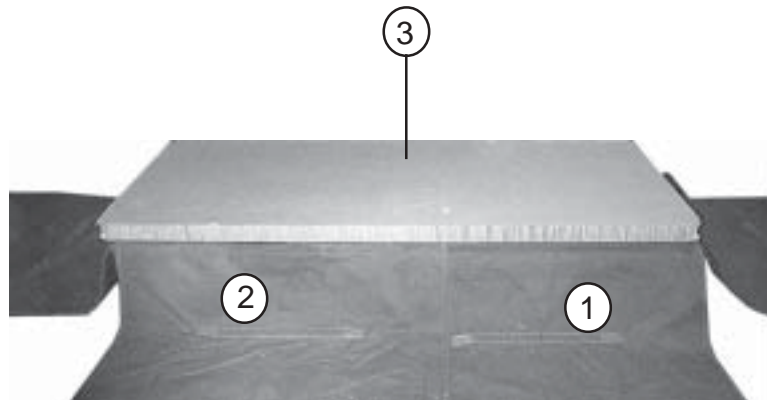

- ① Place the first cover to the front in the same manner as sling assembly. Fold the rear excess even with the layer of honeycomb.
- ② Repeat step 1 for the second cover but position the cover to the rear of the skid.
- ③ Center the second layer of honeycomb on the covers and in the same position as the first layer.

Figure 4-5. Covers and Honeycomb Positioned

POSITIONING LOAD AND CLOSING BAG COVERS

4-12. Center the load so that the weight of the load is evenly distributed. Use honeycomb and cellulose wadding to protect the items. Use cord, rope, or steel strapping to keep the load from shifting. Close the bag as shown in Figure 4-6.

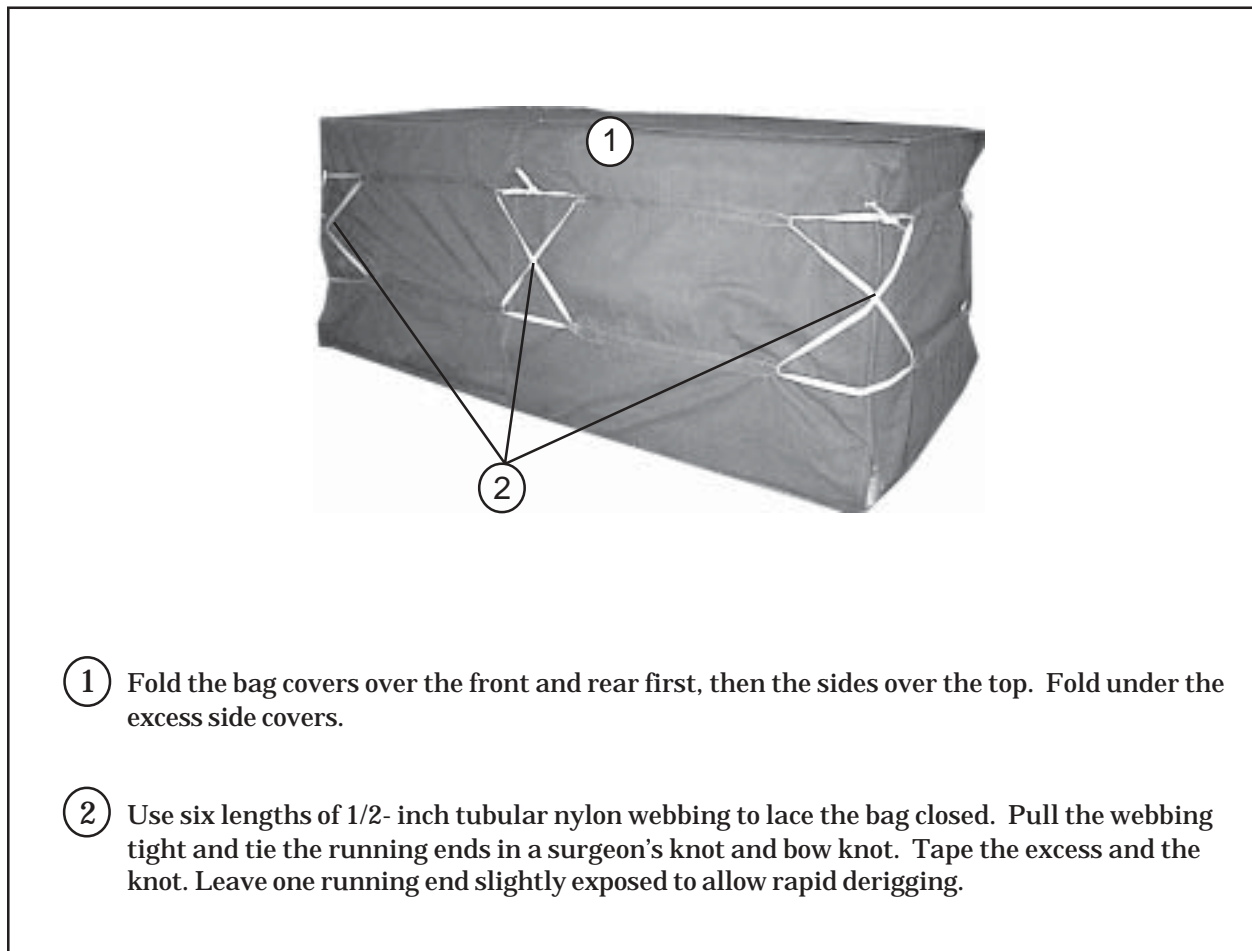
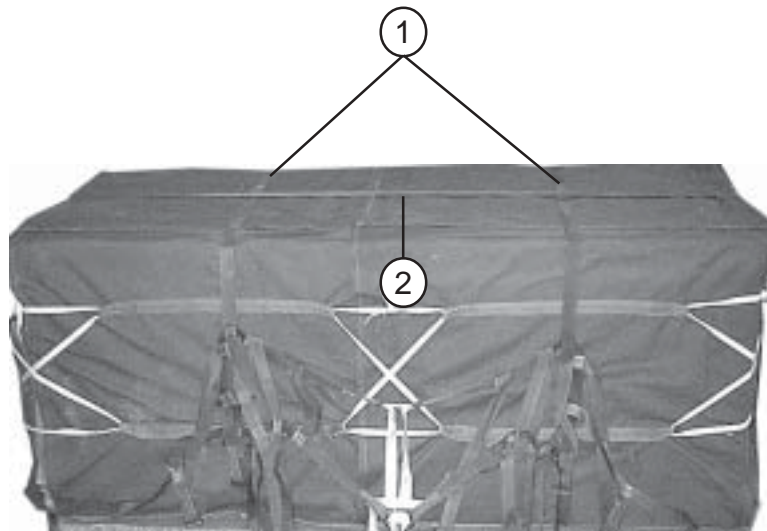

Figure 4-6. A-22 Cargo Bag Covers Closed

SECURING TIE-DOWN STRAPS

4-13. Secure the tie-down straps as shown in Figure 4-7.



- ① Route the side tie-down straps through the opposing friction adapters. Apply tension to the straps.
- ② If necessary, attach a 36 or 60 inch type VIII nylon webbing strap to either the front or rear tie-down strap. Route the running end through the friction adapter on the opposite end and tie an overhand knot in the running end.
- ③ Fold the excess on the tie-down straps and tape or tie it. (not shown)

Figure 4-7. Tie-Down Straps Secured

SECURING LATERAL STRAPS

4-14. Secure the lateral straps as shown in Figure 4-8.

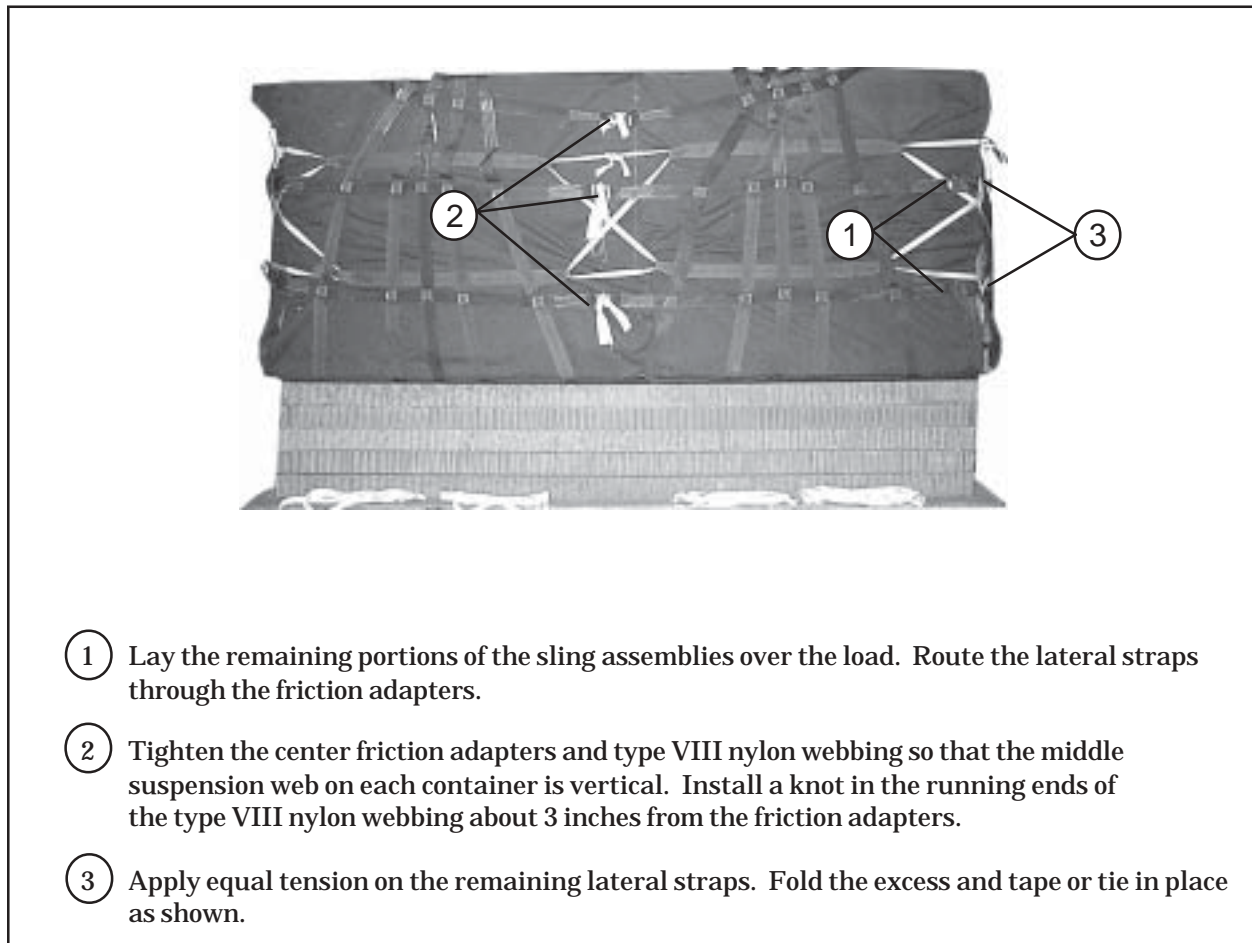
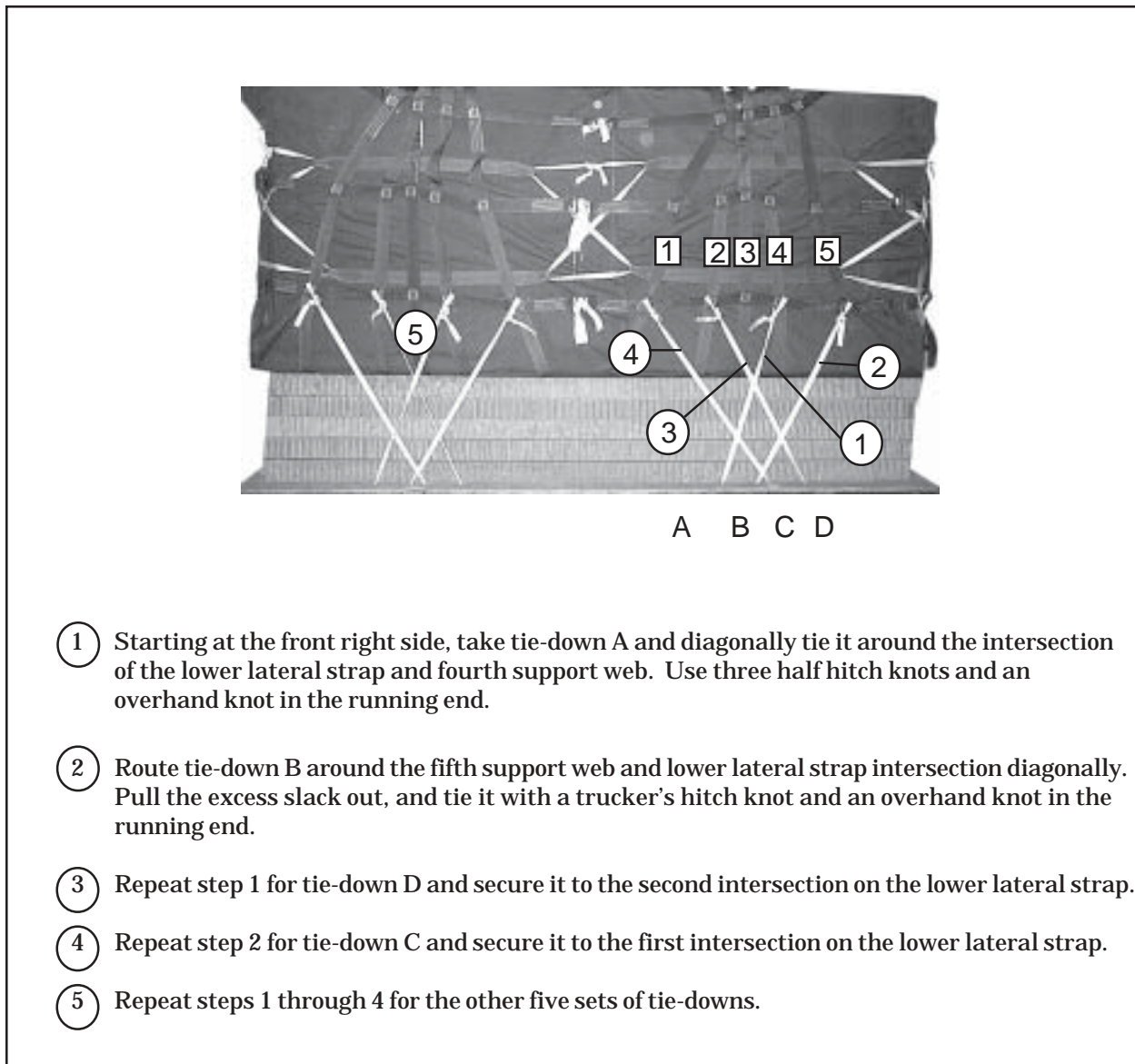

Figure 4-8. Lateral Straps Secured

SECURING SKID BOARD TIES

4-15. Secure the skid board ties as shown in Figure 4-9.



- ① Starting at the front right side, take tie-down A and diagonally tie it around the intersection of the lower lateral strap and fourth support web. Use three half hitch knots and an overhand knot in the running end.
- ② Route tie-down B around the fifth support web and lower lateral strap intersection diagonally. Pull the excess slack out, and tie it with a trucker's hitch knot and an overhand knot in the running end.
- ③ Repeat step 1 for tie-down D and secure it to the second intersection on the lower lateral strap.
- ④ Repeat step 2 for tie-down C and secure it to the first intersection on the lower lateral strap.
- ⑤ Repeat steps 1 through 4 for the other five sets of tie-downs.

Figure 4-9. Skid Board Ties Secured

INSTALLING SUSPENSION SLINGS

4-16. Install suspension slings using six suspension webs, two 3/4-inch cargo suspension clevises, and two 3-foot (2-loop), type XXVI nylon webbing slings as shown in Figure 4-10.

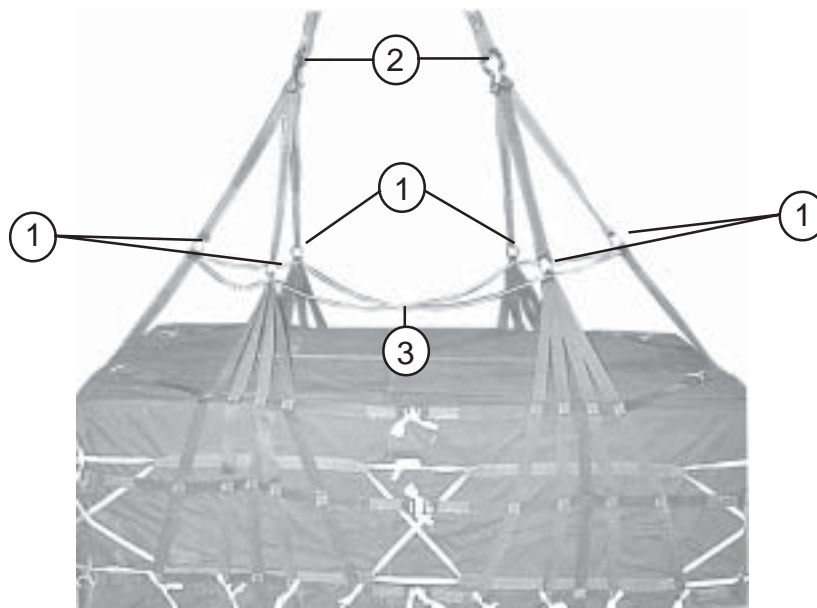

- ① Attach one suspension web to each of the six D-rings. Route the snap hook from outside to inside. Wrap each hook with masking tape.
- ② Place a 3-foot sling on each clevis. Bolt the three suspension webs at the front of the load to one clevis. Repeat step for the rear set.
- ③ Route a length of type III nylon cord through the six D-rings as shown above. Tie the ends together. Make sure the tie has excess to allow suspension sling movement.

Figure 4-10. Suspension Slings Installed

INSTALLING PARACHUTE

4-17. Install a reefed G-12 cargo parachute as shown in Figure 4-11.

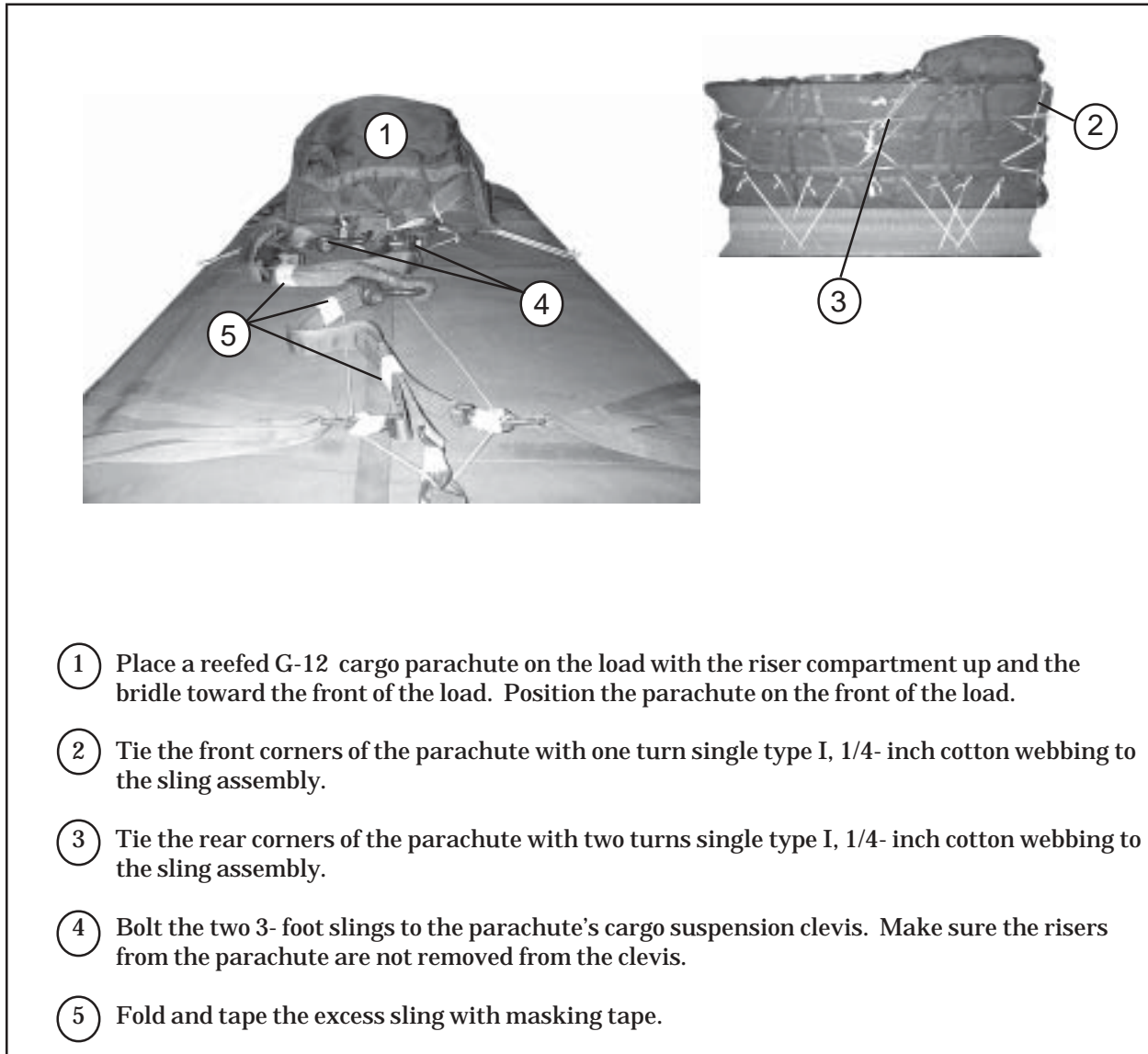

Figure 4-11. Reefed G-12 Cargo Parachute Installed

MARKING RIGGED LOAD

4-18. Mark the rigged load according to FM 10-500-3/TO 13C7-1-11 and as shown in Figure 4-12. Compute the rigged load data.

EQUIPMENT REQUIRED

4-19. Use the equipment listed in Table 4-1 to rig the load shown in Figure 4-12.

| | |
|---|--|
|  | |
| RIGGED LOAD | |
| Weight: | Minimum load allowed 2,201 pounds Maximum load allowed 3,375 pounds |
| Height: | 83 inches |
| Width: | 48 inches |
| Length: | 96 inches |

Figure 4-12. Fully Rigged Double A-22 Container

Table 4-1. Equipment Required for Rigging Double A-22 Container

| National Stock Number | Item | Quantity |
|-----------------------|---|-------------|
| 8040-00-273-8713 | Adhesive Paste | As required |
| 1670-00-587-3521 | Bag, cargo, A-22 | 2 |
| 4030-00-678-8562 | Clevis, suspension, 3/4-inch (medium) | 2 |
| 4020-00-240-2146 | Cord, nylon type III | As required |
| 1670-00-753-3928 | Pad, energy dissipating, honeycomb 36-by-96-by-3-inches | 6 sheets |
| No NSN | Parachute: | |
| 1670-00-216-7297 | Cargo, G-12 Reefed | 1 |
| | Pilot, 68-in diam | 1 |
| 5530-00-914-5118 | Plywood, 1-by-48-by-96-inch | 1 sheet |
| 1670-01-062-6301 | Sling, cargo, airdrop, 3-ft (2 loop), type XXVI nylon webbing | 2 |
| 7510-00-266-6710 | Tape, masking, 2-inch | As required |
| 8310-01-102-4478 | Thread, cotton, ticket number 8/7 | As required |
| 8305-00-268-2411 | Webbing: Cotton, 1/4-inch, type I | As required |
| 8305-00-082-5752 | Nylon, tubular, 1/2-inch | As required |
| 8305-00-263-3591 | Type VIII | As required |

SECTION III - ALTERNATE RIGGING METHOD FOR DOUBLE A-22 CONTAINER

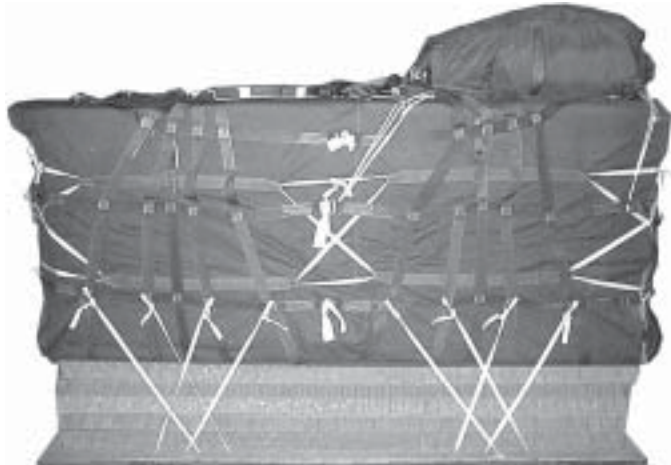
BUILDING AND POSITIONING A-22 CONTAINERS

4-20. Build two individual A-22 containers in accordance with FM 10-500-3/TO 13C7-1-11/FMFM 7-47 of the same dimensions. Position the two A-22 containers on top of the double skid board and honeycomb kit prepared in Figure 4-3. Ensure that the two individual loads are flush against each other as shown in Figure 4-13.

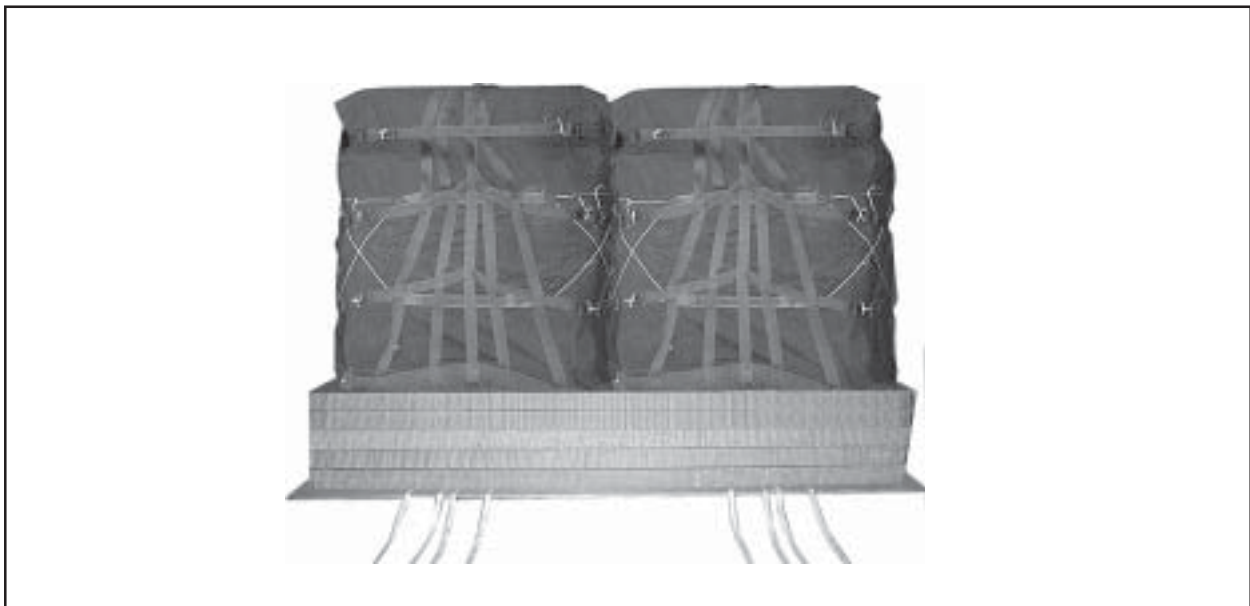

Figure 4-13. A-22 Containers Positioned

JOINING A-22 CONTAINERS

4-21. Join the two assemblies at the mid-section on each side of the load as shown in Figure 4-14.

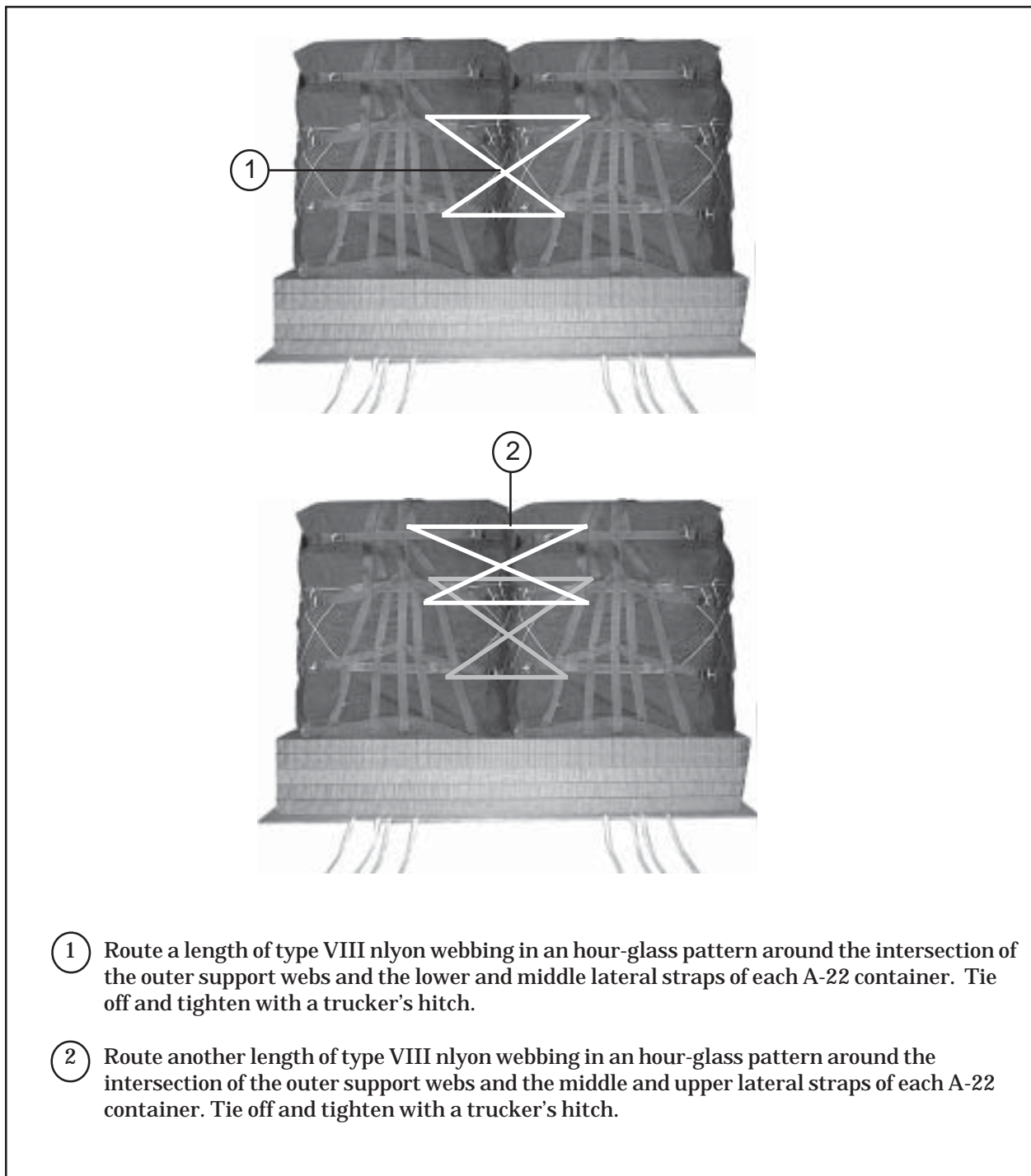

Figure 4-14. A-22 Containers Joined

ATTACHING SUSPENSION WEBS

4-22. Attach suspension webs to the two containers as shown in Figure 4-15.

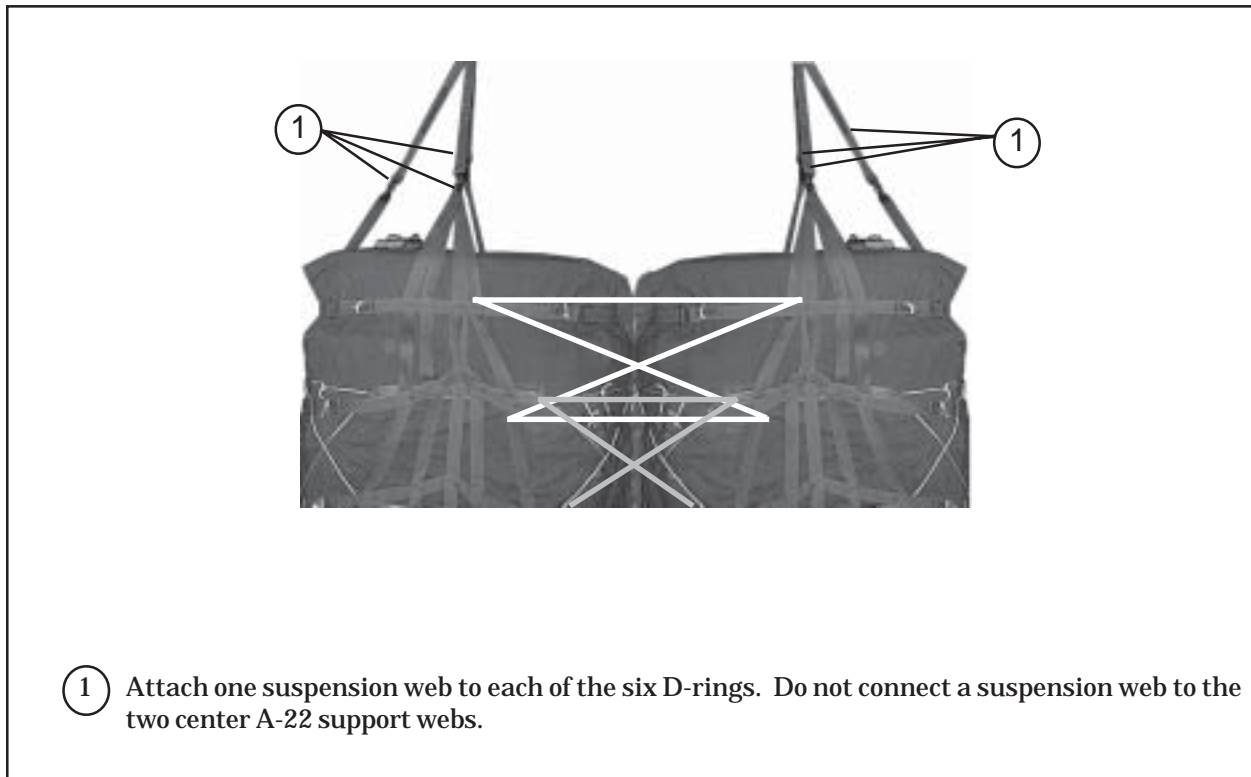

Figure 4-15. Suspension Webs Attached

TYING OFF UNUSED SUSPENSION WEBS

4-23. Fold each unused suspension web on top of the half of the load to which it was originally rigged as shown in Figure 4-16.

INSTALLING SUSPENSION SLINGS

4-24. Install the suspension slings and complete the rest of the rigging in accordance with procedures for a reefed G-12 parachute on a double A-22 container.

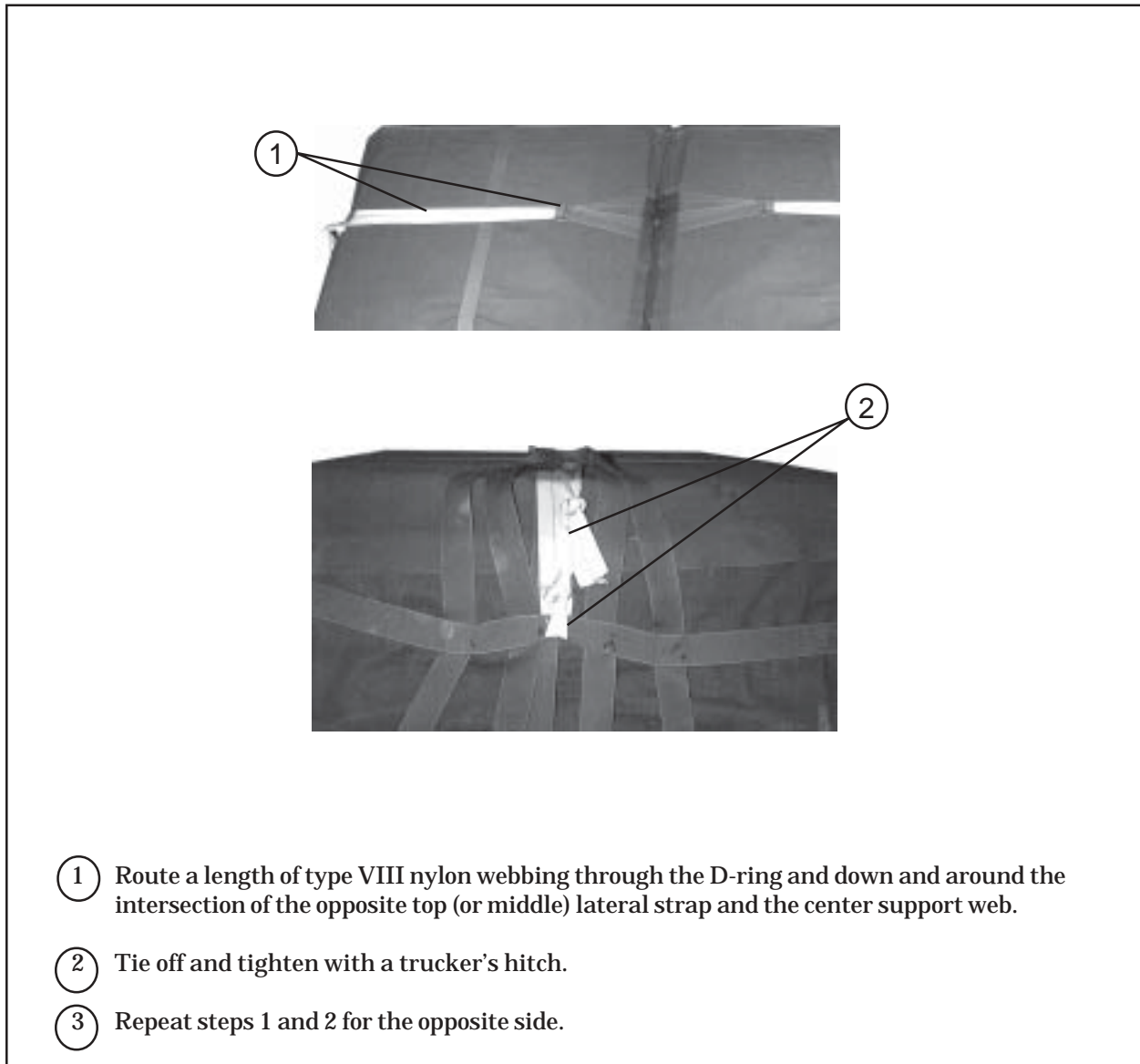

Figure 4-16. Off Unused Suspension Webs Tied Off

Chapter 5

Rigging Quadruple A-22 Container Loads For High Velocity Airdrop

SECTION I - GENERAL INFORMATION FOR QUADRUPLE A-22 CONTAINER

QUADRUPLE A-22 CONTAINER COMPONENTS

5-1. The quadruple A-22 container, shown in Figure 5-1, employs four standard A-22 sling assemblies which can be laced together to form a larger container. The system employs a reefed G-12 parachute.

QUADRUPLE A-22 CONTAINER SKID BOARD

5-2. The sling assemblies are secured to a 1-1/2 or 2- by 96- by 96- inch plywood (Grade AC) skid board with 1/2- inch tubular nylon webbing. Honeycomb is positioned between the container and the skid board for impact cushioning.



Figure 5-1. Fully Rigged Quadruple A-22 Container System

QUADRUPLE A-22 CONTAINER LIMITATIONS

5-3. The quadruple A-22 container has a weight restriction of 3,500 to 4,375 pounds, excluding the weight of the parachute.

ASSEMBLY LINE RIGGING

5-4. When assembly line rigging is used for quadruple A-22 container loads, five stations are needed. The stations are: laying out containers and preparing base, positioning load, rigging load, installing parachute, and inspecting the rigged load.

INSPECTION OF LOAD

5-5. The quadruple A-22 container load must be inspected by a qualified rigger. While being rigged, this load should be supervised or rigged by a parachute rigger. DD Form 1748-1 must be completed before airdrop.

PARACHUTE USED

5-6. The system employs a reefed G-12 parachute with both skirt and vent reefing. Procedures for packing the G-12 reefed parachute can be found in Chapter 1, Section II of this manual.

SECTION II - RIGGING OVERSIZED ITEMS IN QUADRUPLE A-22 CONTAINER

SYSTEM DESCRIPTION

5-7. A typical load is rigged for high-velocity airdrop using four A-22 sling assemblies. Quadruple A-22 container loads must weigh at least 3,500 pounds but not exceed 4,375 pounds, excluding the weight of the parachute. The load is rigged with a reefed G-12 parachute. Typical oversized items include winterization kits which include stoves, tents, long rolls of plastic, sleeping bags, blankets, etc.

PREPARING ITEMS AND SKID BOARD

5-8. The skid board will consist of four 1- by 48- by 96-inch sheets of plywood. At least two of the sheets must be AC grade plywood. The other two sheets can be Grade D or better. Prepare the skid board according to Figure 5-2. Prepare the drop items according to the load's sensitivity. Items must be well padded to prevent damage during airdrop.

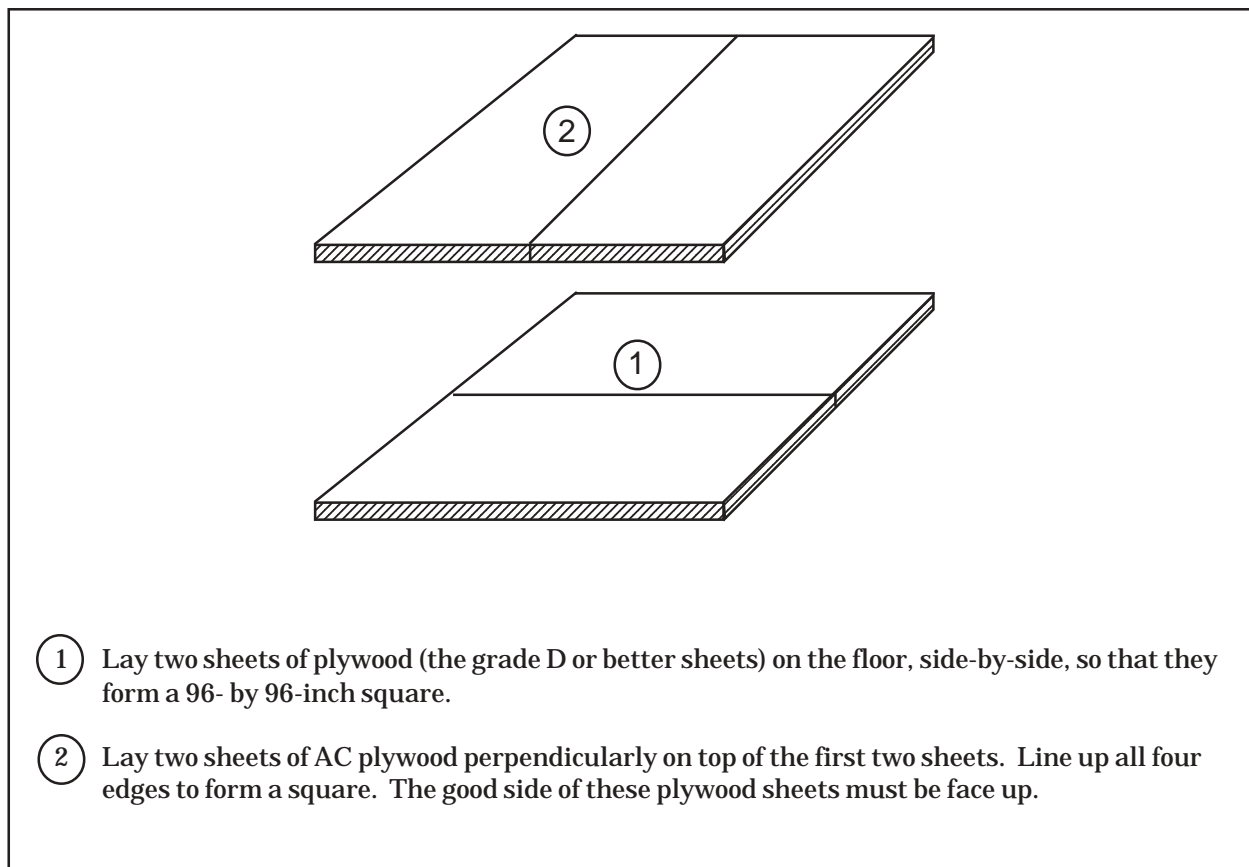

Figure 5-2. Skid Board Prepared

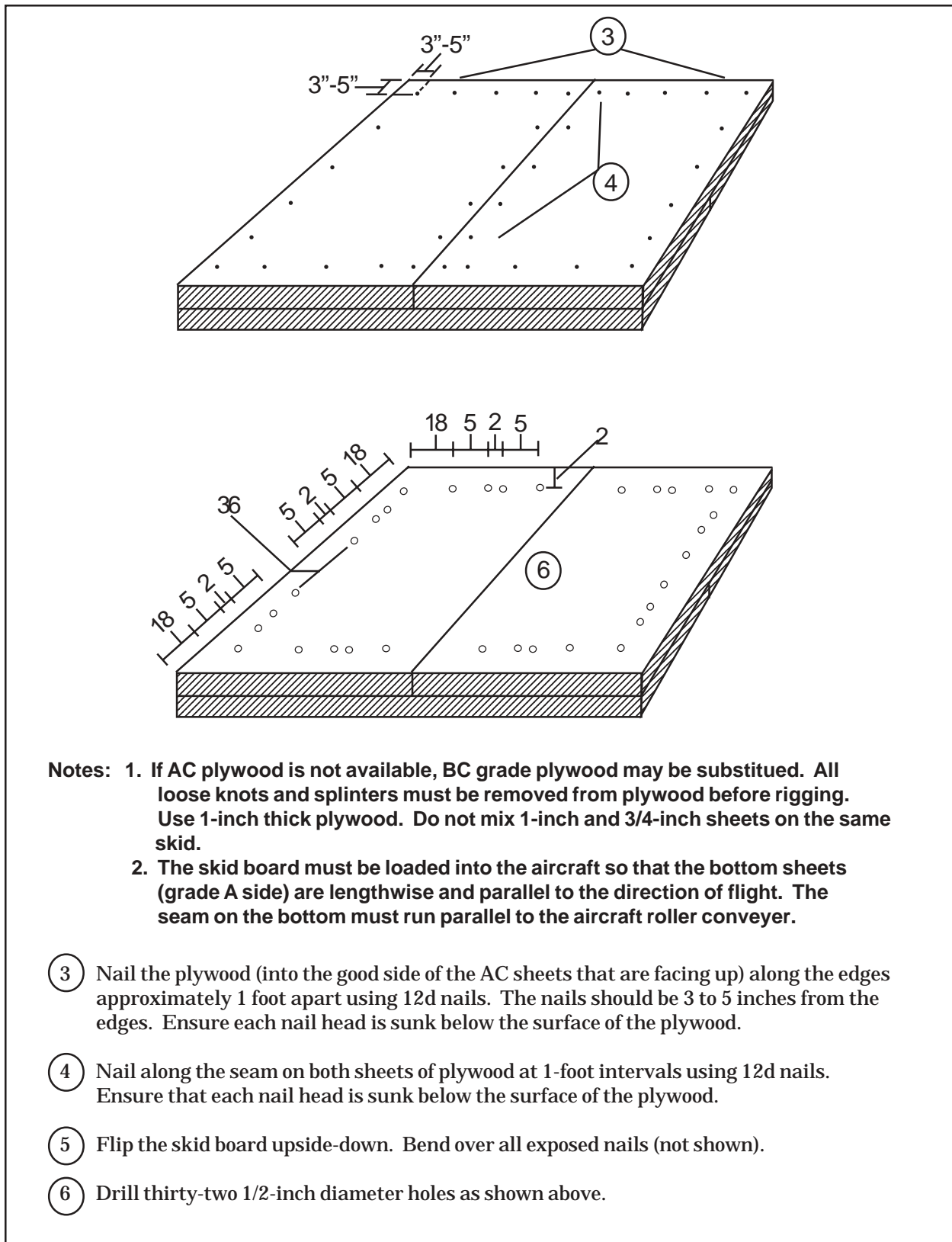

Figure 5-2. Skid Board Prepared (continued)

PREPARING SKID BOARD TIES AND PLACING HONEYCOMB

5-9. Prepare the skid board ties and place the honeycomb as shown in Figure 5-3.

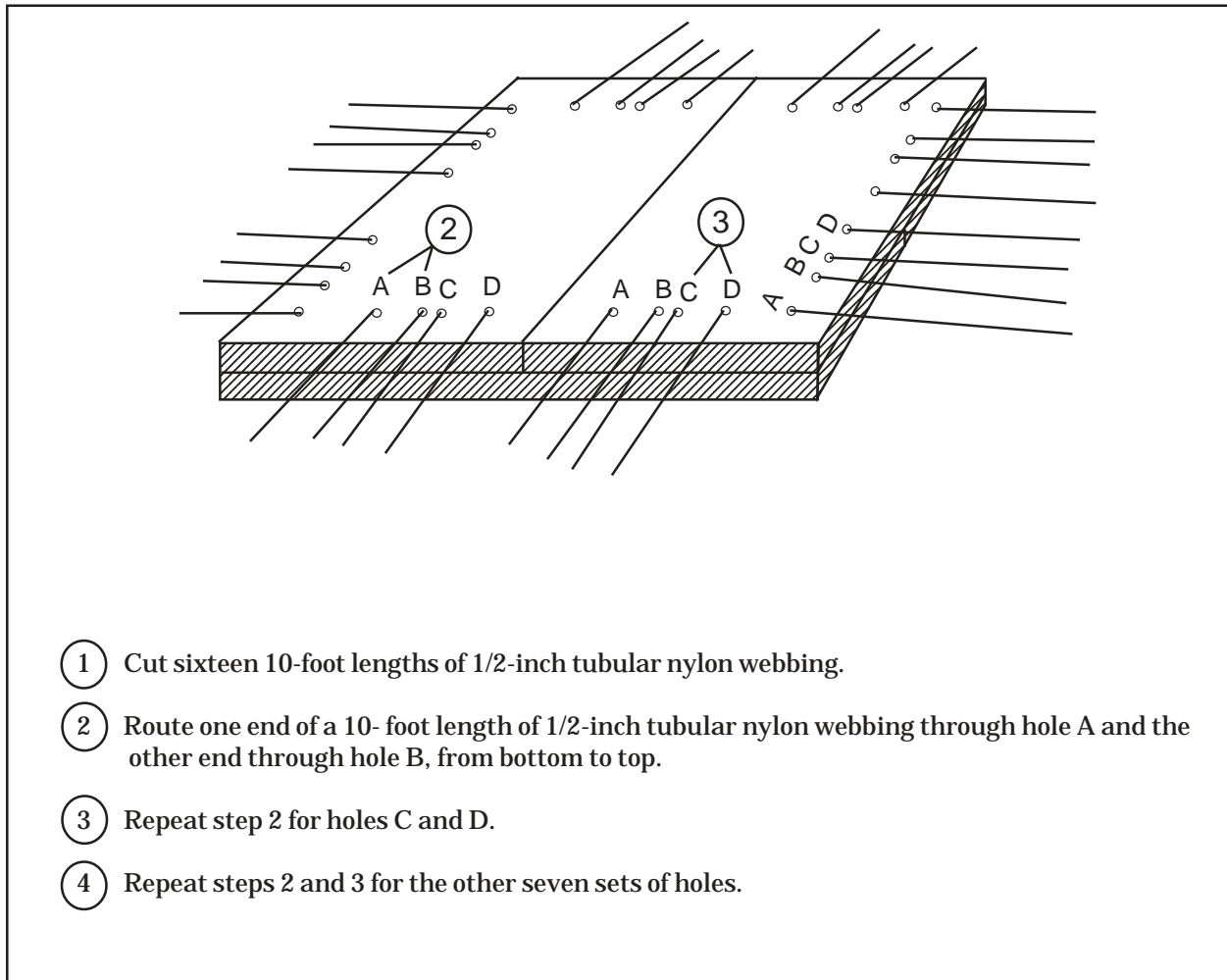

Figure 5-3. Skid Board Ties Prepared and Honeycomb Placed

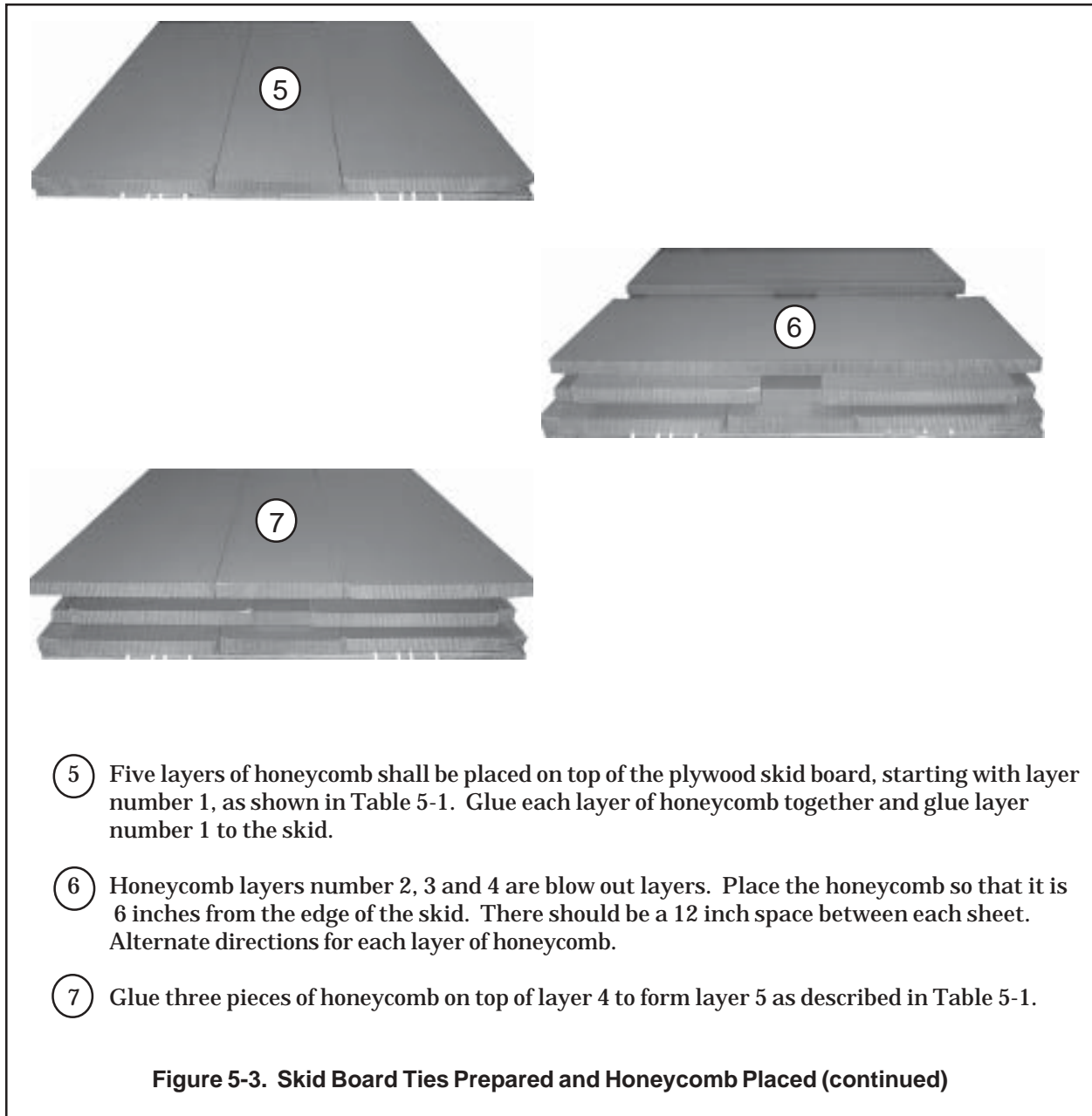

Figure 5-3. Skid Board Ties Prepared and Honeycomb Placed (continued)

| Layer Number | Pieces | Length (inches) | Width (inches) |
|--------------|--------|-----------------|----------------|
| 1 | 2 | 96 | 36 |
| | 1 | 96 | 24 |
| 2 | 2 | 96 | 36 |
| 3 | 2 | 96 | 36 |
| 4 | 2 | 96 | 36 |
| 5 | 2 | 96 | 36 |
| | 1 | 96 | 24 |

Table 5-1. Honeycomb Layers for High Velocity Quad A-22 Loads

POSITIONING A-22 SLING ASSEMBLIES

5-10. Position four A-22 sling assemblies on the quad A-22 load as shown in Figure 5-4.

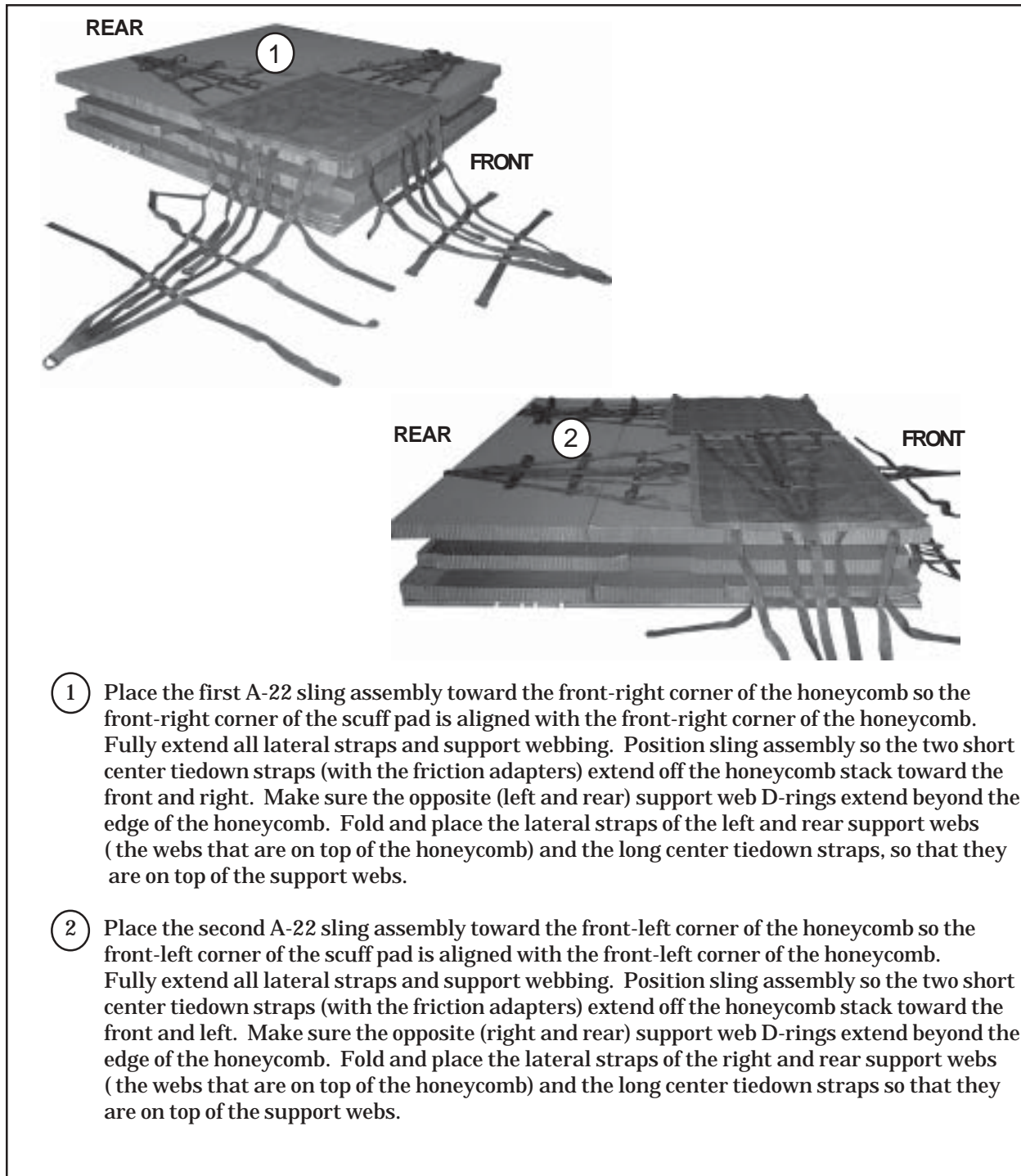

Figure 5-4. A-22 Sling Assemblies Positioned

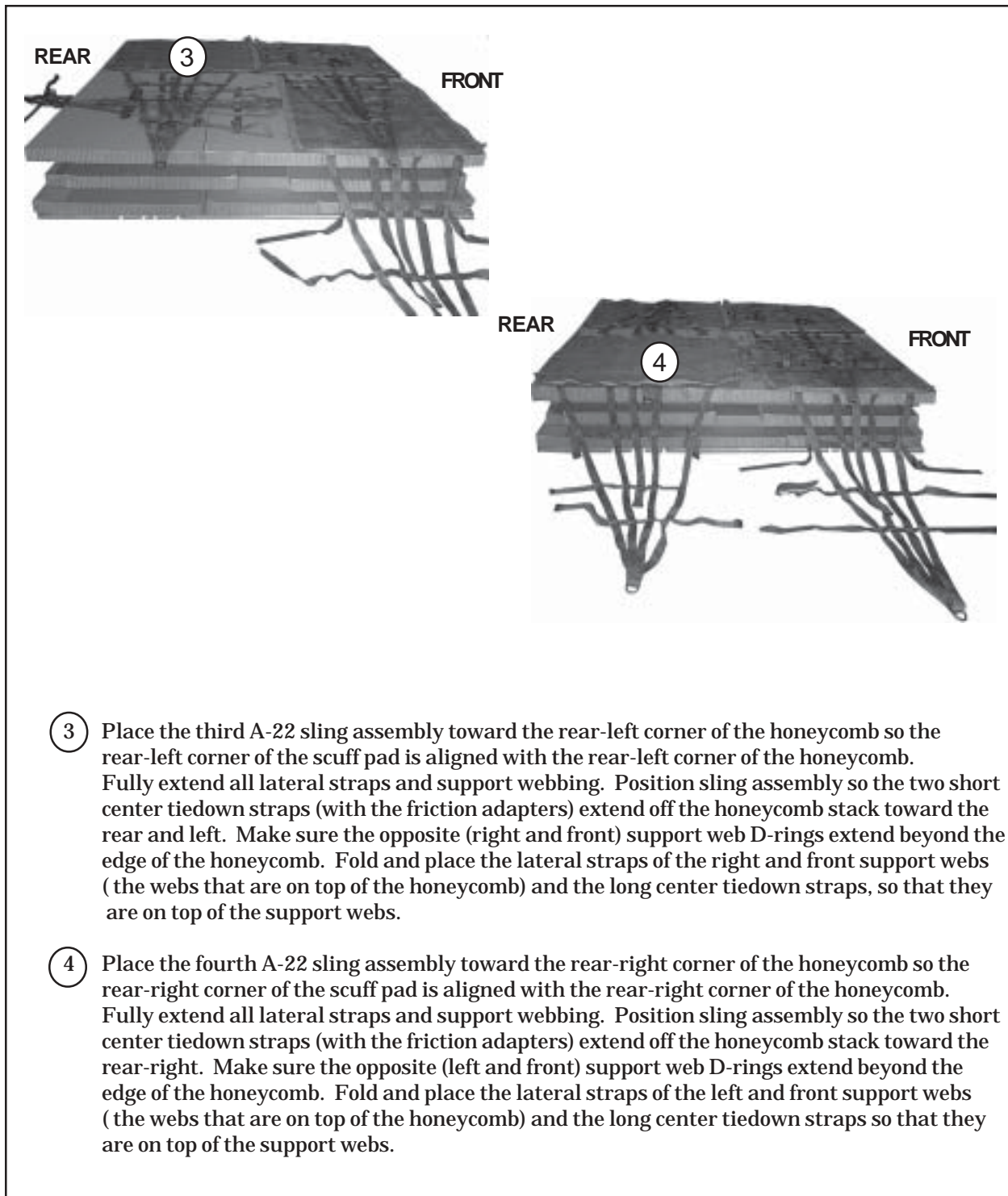
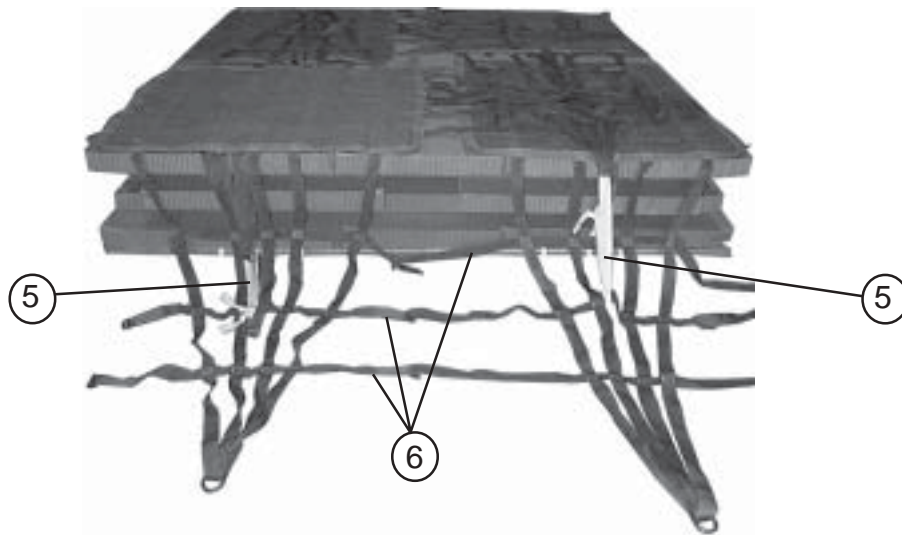

Figure 5-4. A-22 Sling Assemblies Positioned (Continued)



- ⑤ Use lengths of type VIII nylon webbing to tie the eight support web D-rings (that extend beyond the edge of the honeycomb) to the second lateral strap. Ensure that there is no slack between the support web D-ring and the second lateral strap.
- ⑥ Route the 12 lateral straps at the four midsections of the load through each opposing friction adapter. Do not apply tension at this time.

Figure 5-4. A-22 Sling Assemblies Positioned (Continued)

POSITIONING A-22 COVERS

5-11. Use four A-22 cargo bag covers when rigging this load. Position the covers as shown in Figure 5-5.

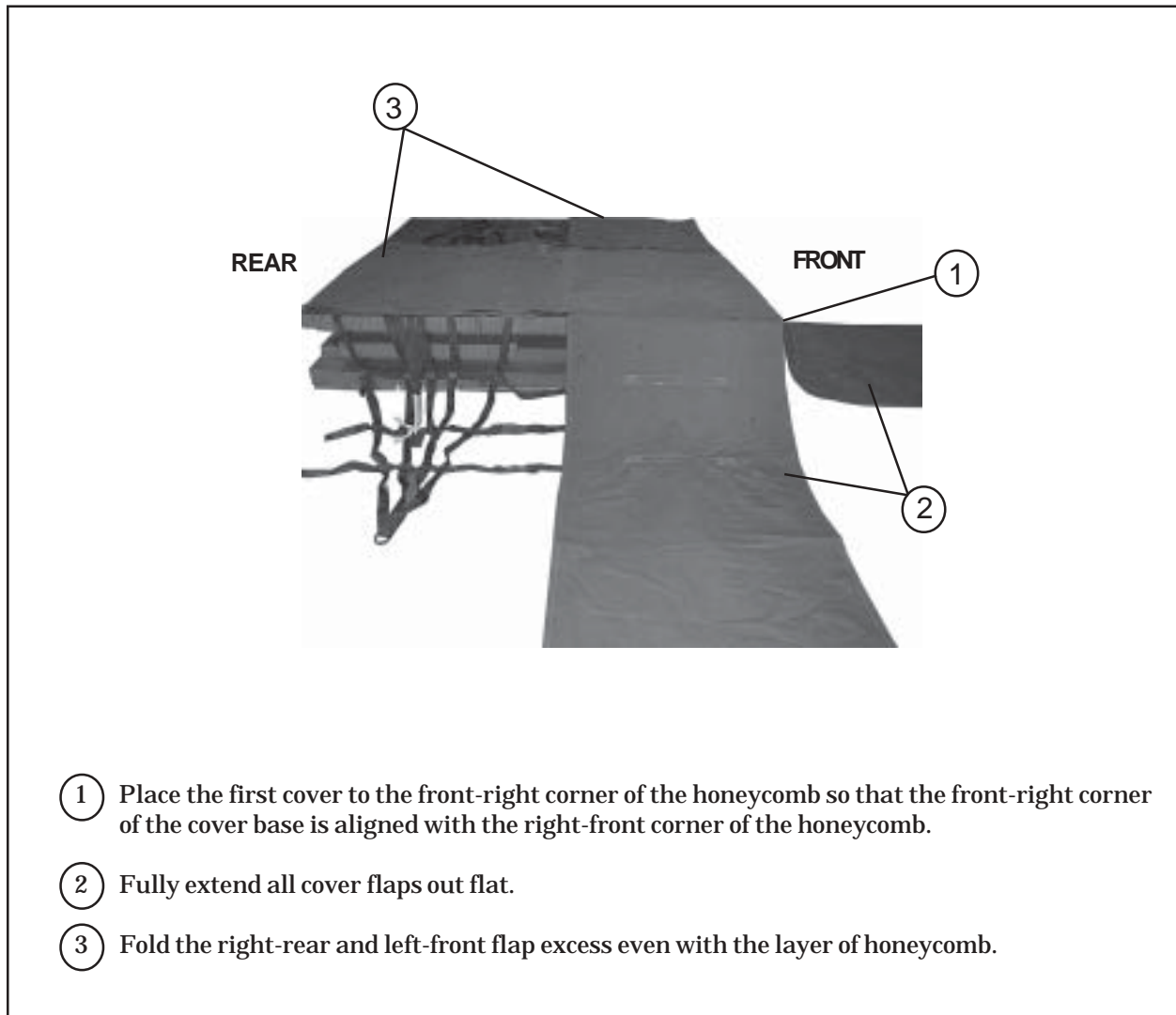
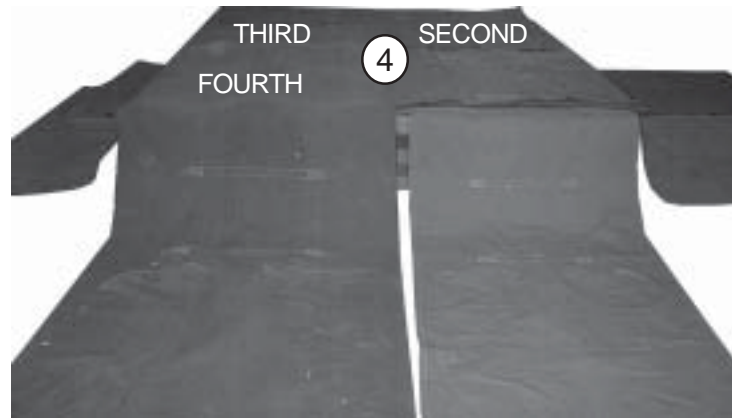

Figure 5-5. A-22 Covers Positioned



- ④ Place the second, third and fourth covers on the left-front, left-rear and right-rear corners, similar to the first cover. Fully extend all flaps and fold the excess so that they do not overhang the honeycomb.

Figure 5-5. A-22 Covers Positioned (Continued)

CONSTRUCTING STORAGE BOX AND PREPARING OVERSIZED ITEM LOAD

5-12. Construct a 96- by 96-inch plywood box using four sheets of 3/4- by 48- by 96-inch plywood as shown in Figure 5-6. Prepare the drop items according to the load's sensitivity.

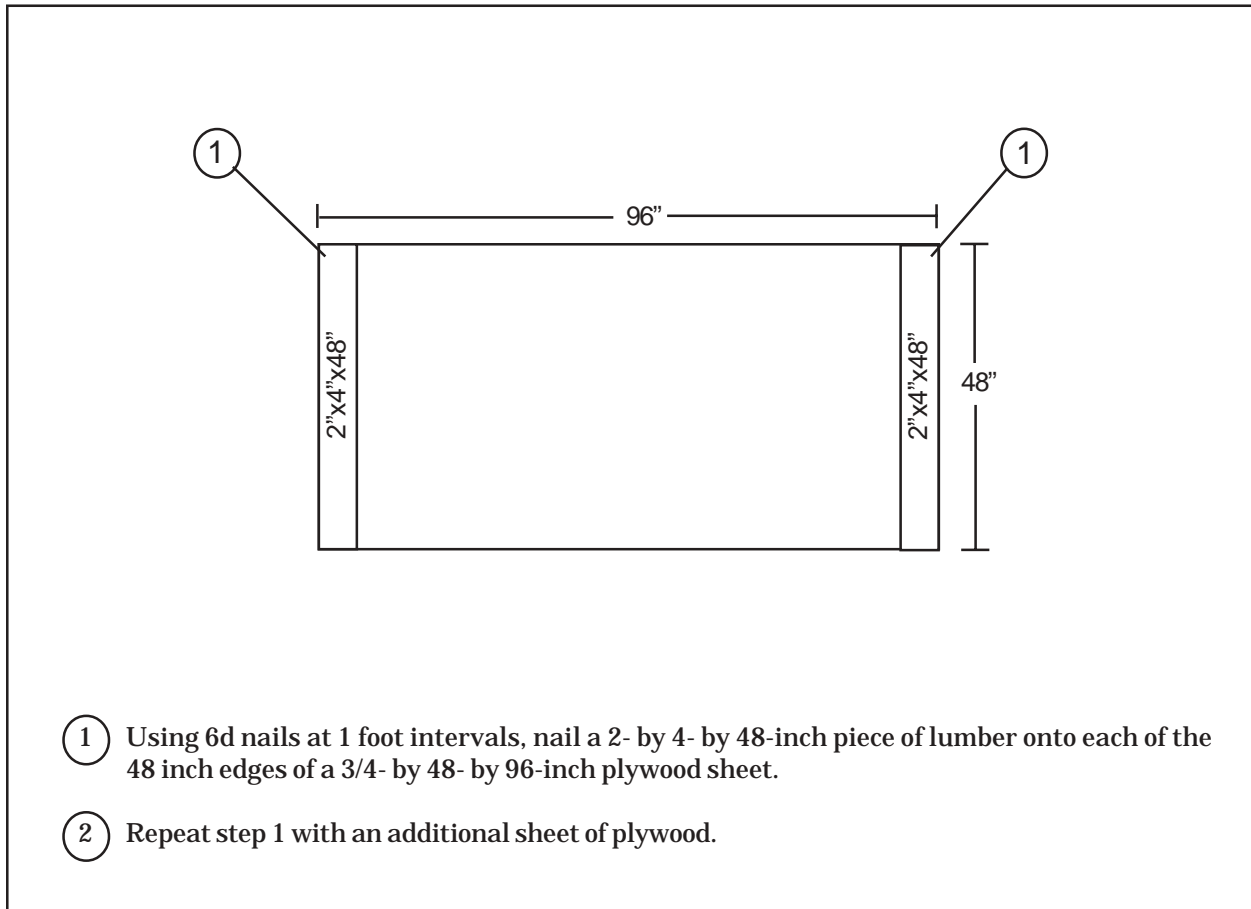
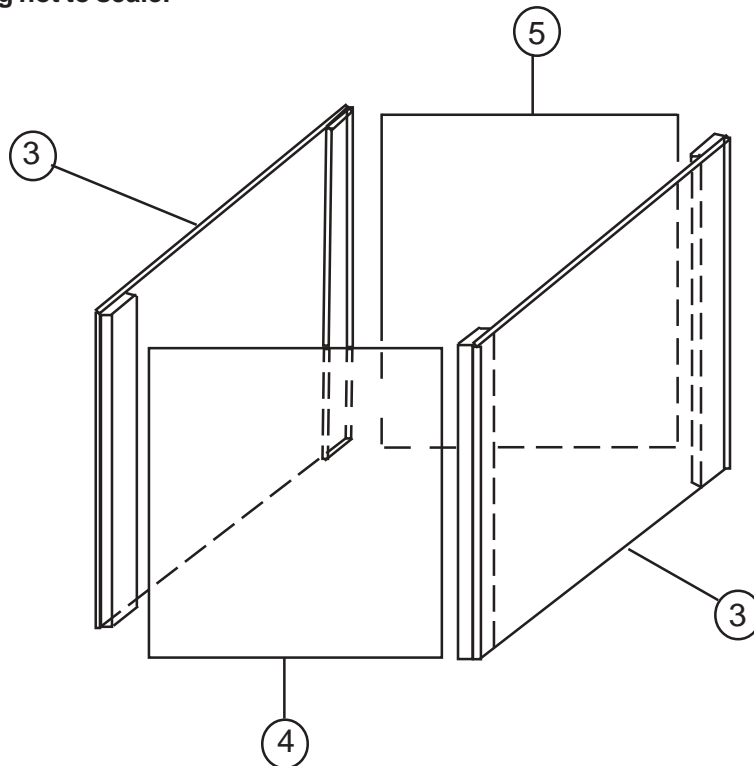

Figure 5-6. Storage Box Constructed and Oversized Item Load Prepared

NOTE: Drawing not to scale.



- ③ Place plywood sheets prepared in steps 1 and 2 on edge and parallel approximately 8 feet apart.
- ④ Position a 3/4 by 48 by 96-inch plywood sheet so that the 48-inch edge covers the exposed edges of both the plywood sheets prepared in steps 1 and 2. Secure by nailing 6d nails at 1 foot intervals through the plywood and into the studs.
- ⑤ Repeat step 4 on the opposite end with an additional sheet of plywood to form a 96- by 96-inch box.

Figure 5-6. Storage Box Constructed and Oversized Item Load Prepared (Continued)

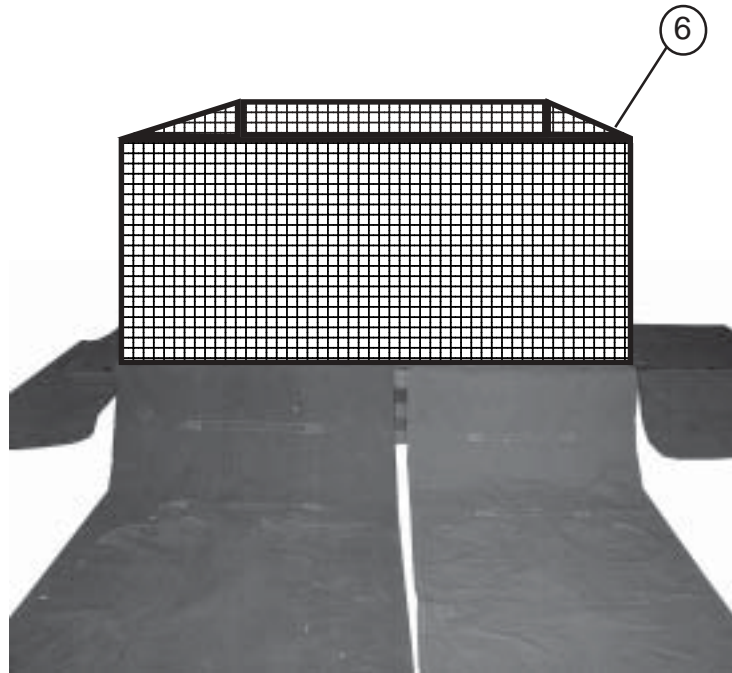

- ⑥ Center the 96- by 96-inch box on top of the prepositioned A-22 cargo bag covers. Large, bulky or heavy items may be placed on the center of the covers prior to positioning the box.

Note: Heavy items must be placed on the bottom. The items must be placed so that the weight of the load is evenly distributed. Place lighter items around and on top of the heavy items.

Figure 5-6. Storage Box Constructed and Oversized Item Load Prepared (Continued)

POSITIONING LOAD AND CLOSING BAG COVERS

5-13. Center the load so that the weight of the load is evenly distributed. Pad items with cellulose wadding or bubble wrap. Place additional items into the box so that the box is completely cubed out. Place additional honeycomb pieces inside the box as necessary to form a level top. Close the bag covers as shown in Figure 5-7.

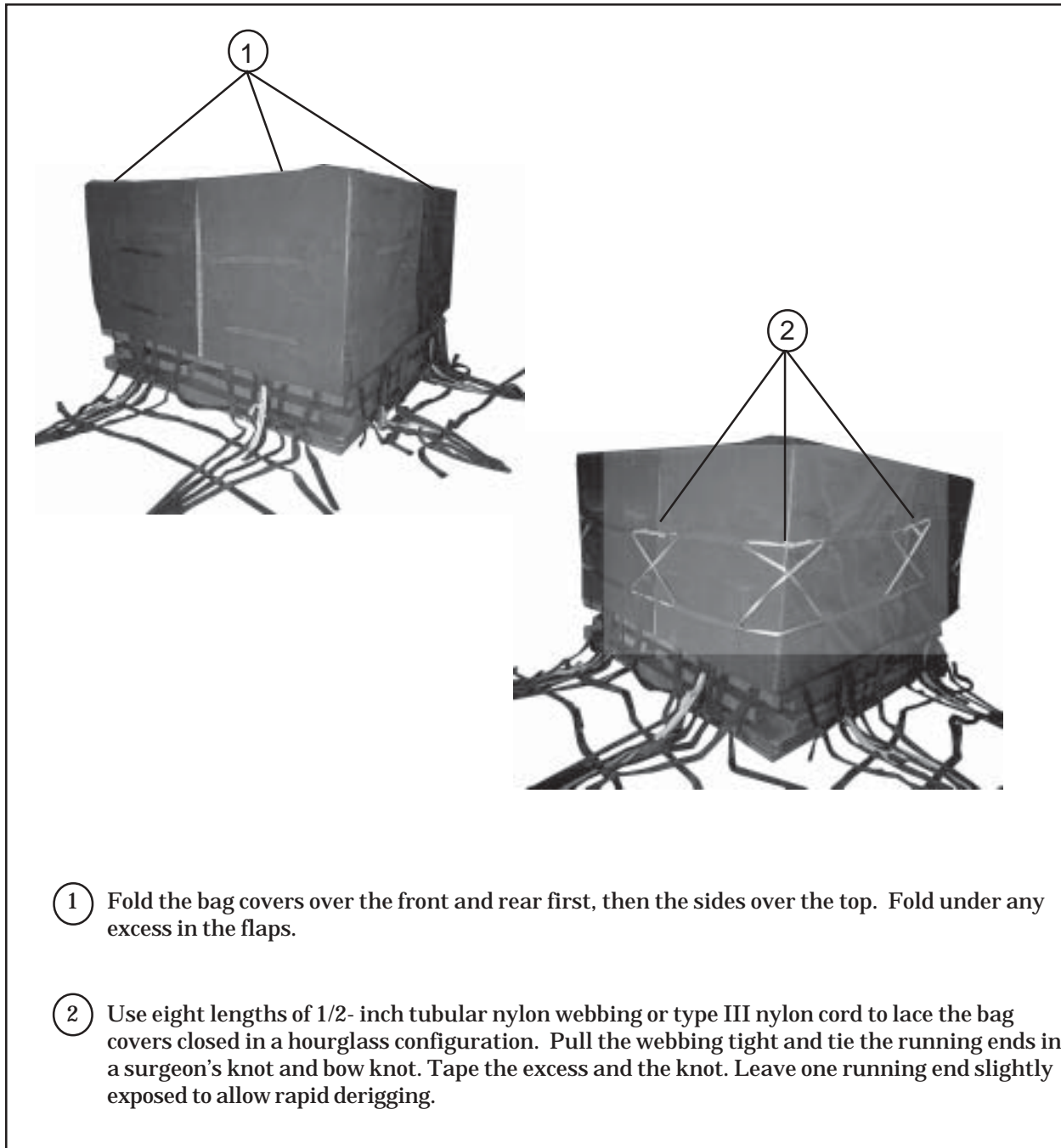

Figure 5-7. A-22 Cargo Bag Covers Closed

SECURING TIE-DOWN STRAPS

5-13. Secure the tie-down straps as shown in Figure 5-8.

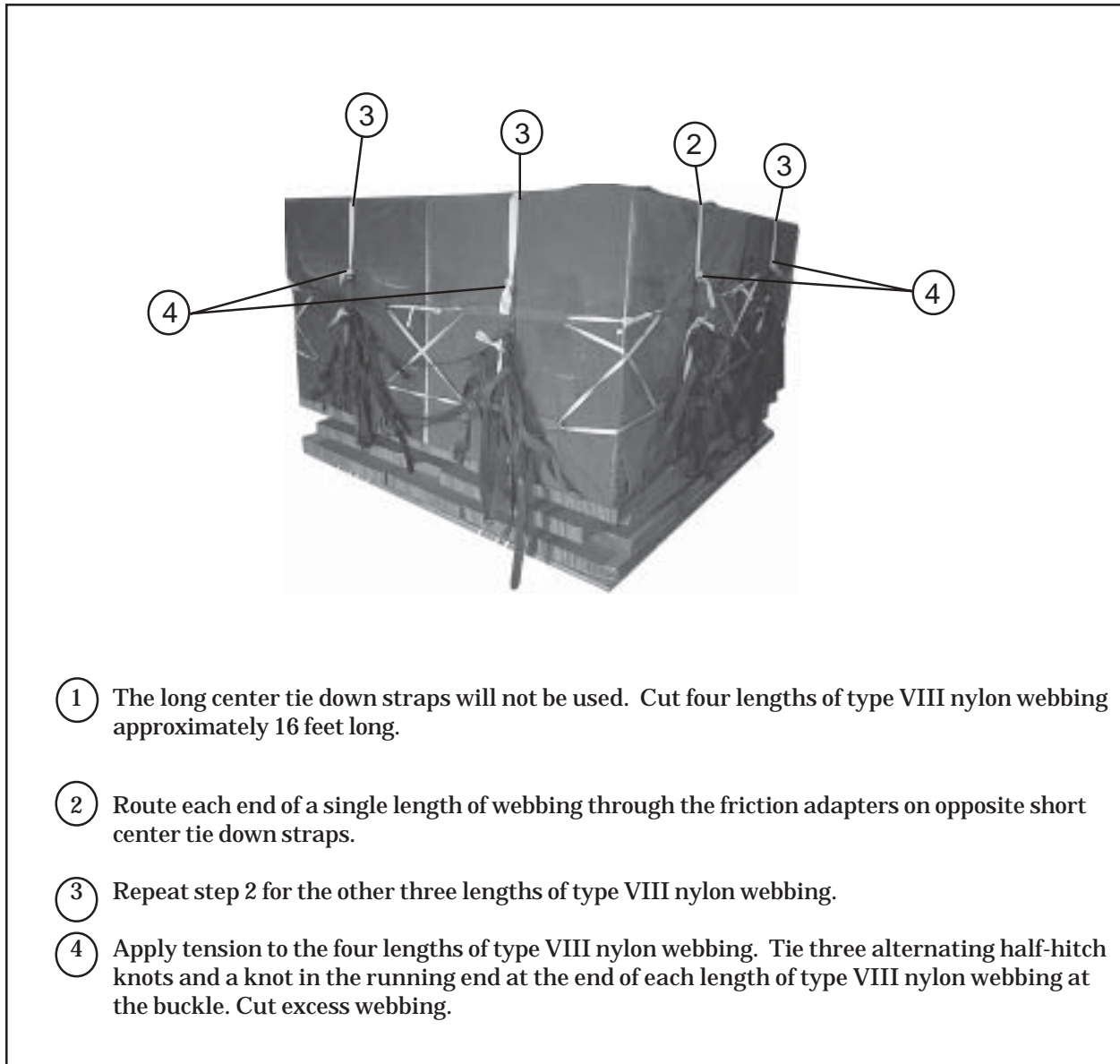
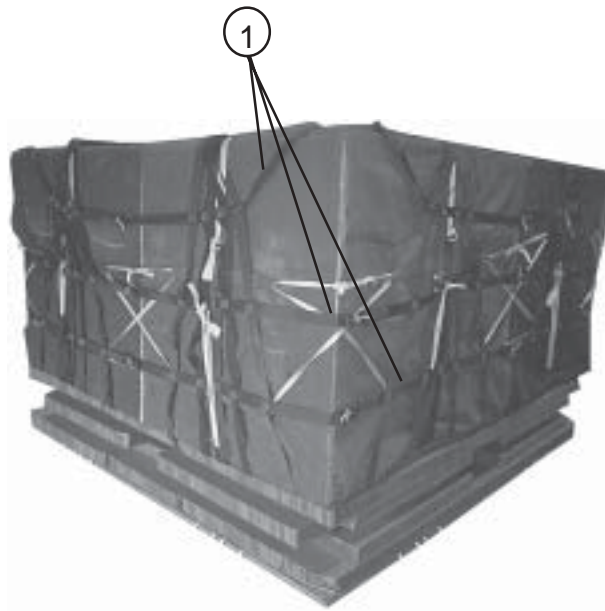

Figure 5-8. Tie-Down Straps Secured

SECURING LATERAL STRAPS

5-15. Secure the lateral straps as shown in Figure 5-9.



Note: If the top lateral straps are on top of the load, make sure they are loosely tightened.

- ① Lay the remaining portions of the sling assemblies over the load. Route the corner lateral straps through the friction adapters.
- ② Tighten the center friction adapters so that the middle suspension web on each support web is vertical.
- ③ Apply equal tension on the remaining lateral straps. Fold the excess and tape or tie in place (not shown).

Figure 5-9. Lateral Straps Secured

SECURING SKID BOARD TIES

5-16. Secure the skid board ties as shown in Figure 5-10.

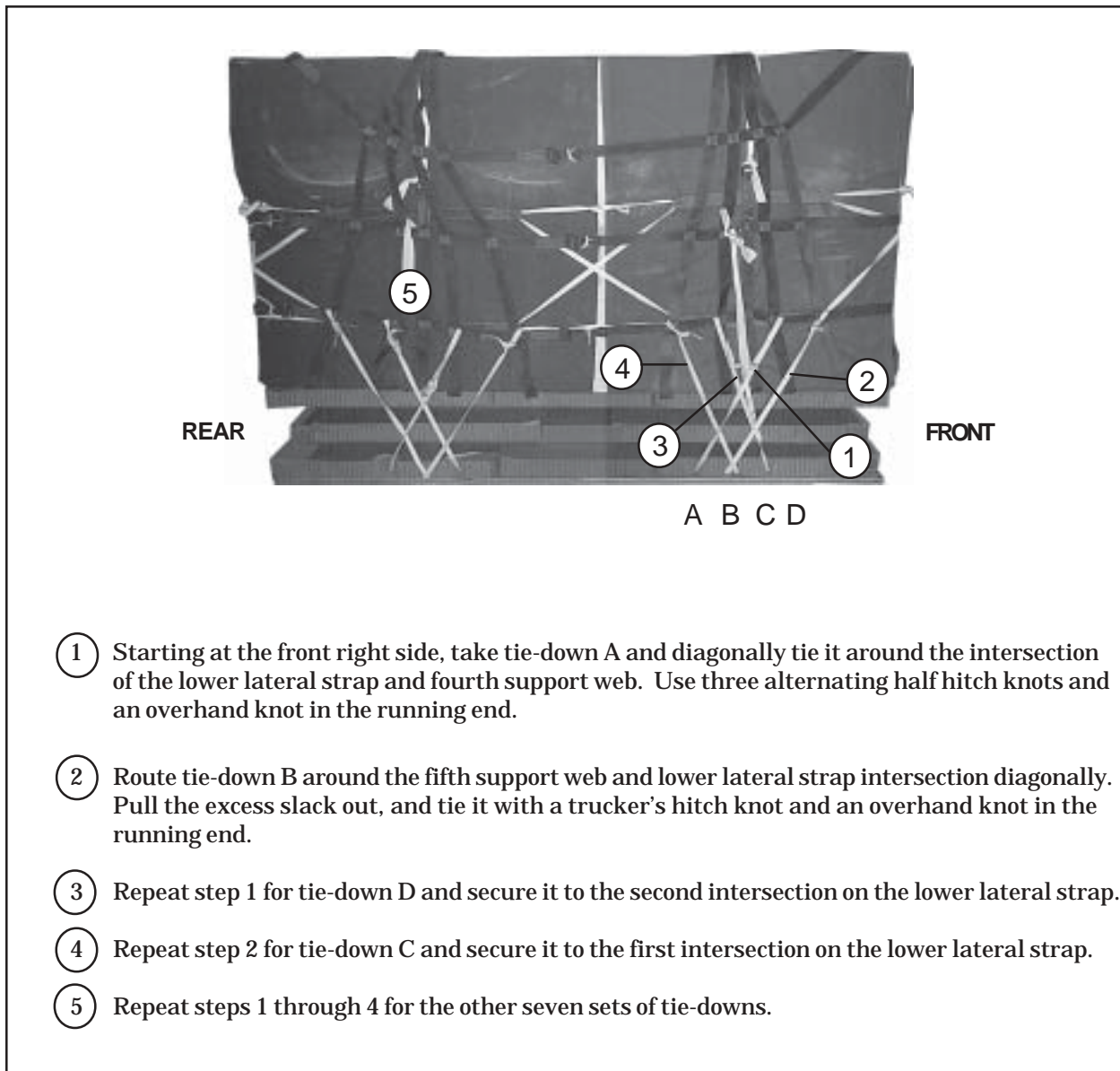

- ① Starting at the front right side, take tie-down A and diagonally tie it around the intersection of the lower lateral strap and fourth support web. Use three alternating half hitch knots and an overhand knot in the running end.
- ② Route tie-down B around the fifth support web and lower lateral strap intersection diagonally. Pull the excess slack out, and tie it with a trucker's hitch knot and an overhand knot in the running end.
- ③ Repeat step 1 for tie-down D and secure it to the second intersection on the lower lateral strap.
- ④ Repeat step 2 for tie-down C and secure it to the first intersection on the lower lateral strap.
- ⑤ Repeat steps 1 through 4 for the other seven sets of tie-downs.

Figure 5-10. Skid Board Ties Secured

INSTALLING SUSPENSION SLINGS

5-17. Install suspension slings using support webs, type V platform clevises, and two 20-foot (2-loop), type XXVI nylon webbing slings (two 12-foot (2-loop), type XXVI nylon webbing slings girth hitched together, may also be used to form a single 20-foot sling) as shown in Figure 5-11.

Note: Do not mix 12-foot and 20-foot slings on the same load.

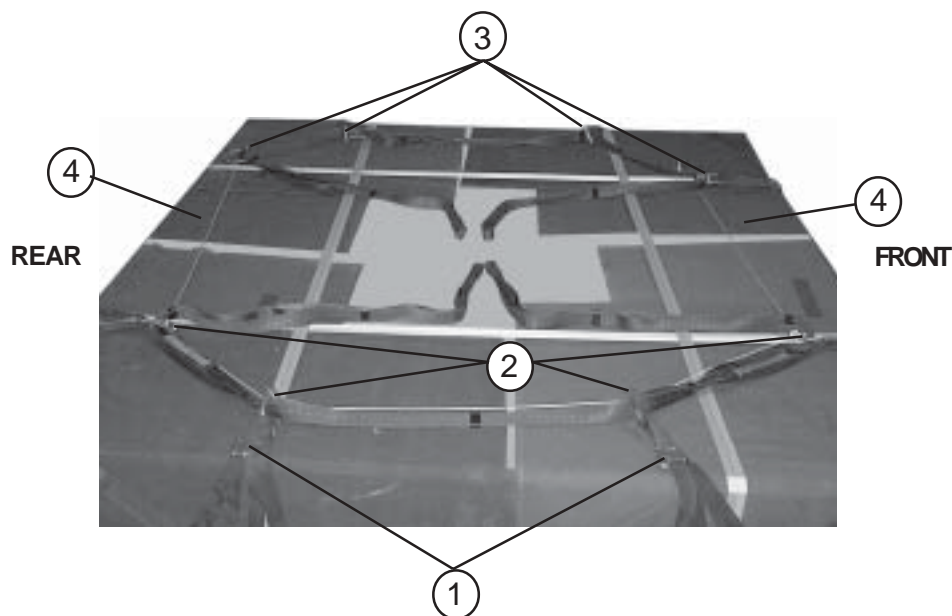

- ① Move the D-ring on the support webs down and tape in place. Install a type V platform clevis on each support web, at the former location of the D-rings.
- ② Run a single type XXVI nylon suspension sling through the four type V platform clevises of the front-right and rear-right support webs.
- ③ Repeat step 2 for the rear-left and front-left support webs.
- ④ Route a length of type III nylon cord through the eight type V platform clevises as shown above. Tie the ends together. Make sure the tie has excess to allow suspension sling movement.

Figure 5-11. Suspension Slings Installed

INSTALLING PARACHUTE

5-18. Install a reefed G-12 cargo parachute as shown in Figure 5-12.

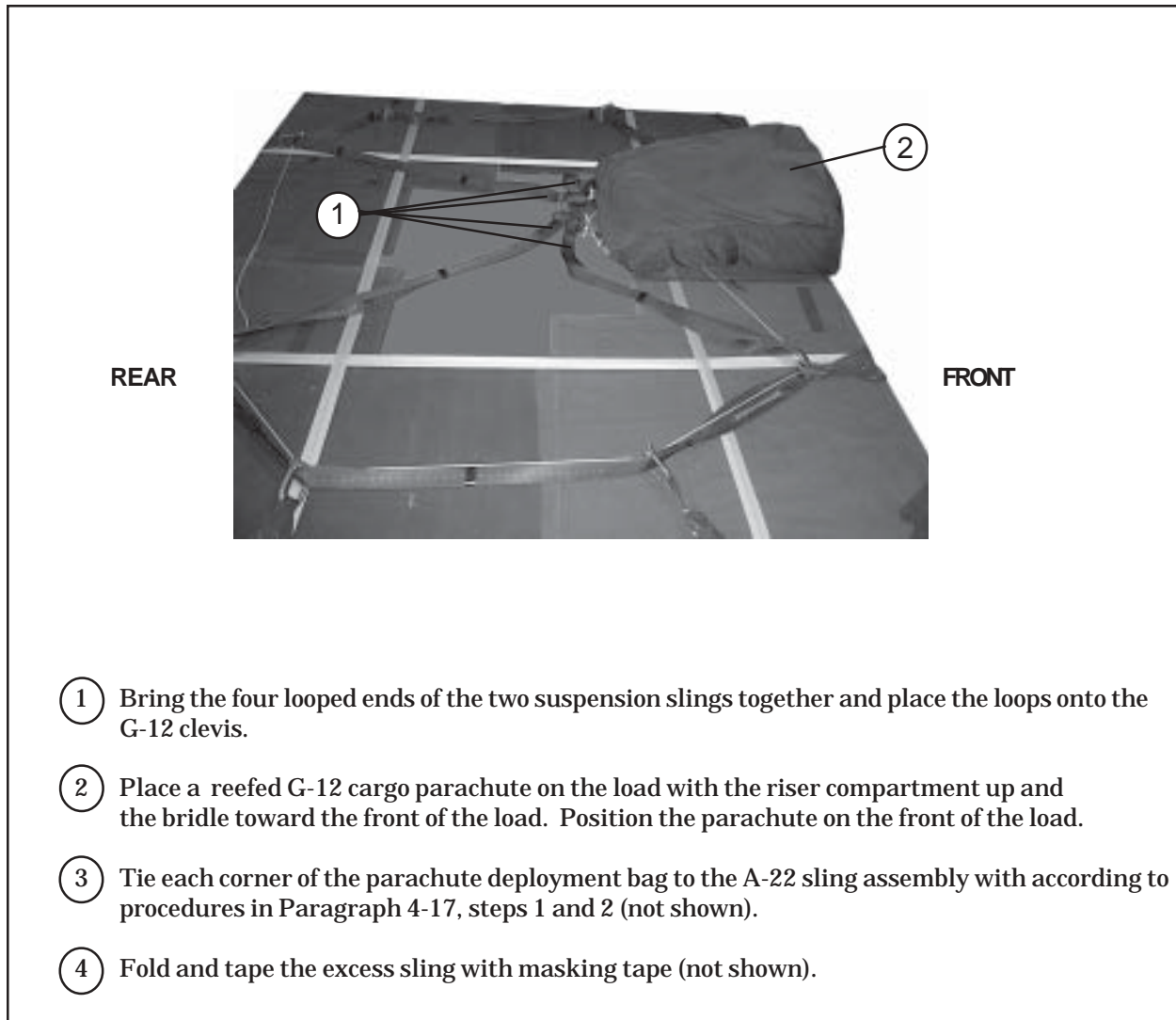

Figure 5-12. Reefed G-12 Cargo Parachute Installed

MARKING RIGGED LOAD

5-19. Mark the rigged load according to FM 10-500-3/TO 13C7-1-11 and as shown in Figure 5-13. Compute the rigged load data.

EQUIPMENT REQUIRED

5-20. Use the equipment listed in Table 5-2 to rig the load shown in Figure 5-13.



RIGGED LOAD

| | | |
|---------|----------------------------|--------------|
| Weight: | Minimum load allowed | 3,500 pounds |
| | Maximum load allowed | 4,375 pounds |
| Height: | | 83 inches |
| Width: | | 96 inches |
| Length: | | 96 inches |

Figure 5-13. Fully Rigged Quadruple A-22 Container

Table 5-2. Equipment Required for Rigging Oversized Items in Quadruple A-22 Container

| National Stock Number | Item | Quantity |
|-----------------------|--|-------------|
| 8040-00-273-8713 | Adhesive Paste | As required |
| 1670-01-162-2372 | Clevis, cargo, type V | 8 |
| 1670-00-587-3521 | Bag, cargo, A-22 | 4 |
| 1670-01-062-6302 | Sling, cargo, airdrop, 20-ft (2 loop), type XXVI nylon webbing | 2 |
| 1670-01-062-6303 | Sling, cargo, airdrop, 12-ft (2 loop), type XXVI nylon webbing | 4 |
| | Nail, steel, wire, common: | |
| 5315-00-010-4657 | 6d | As required |
| 5315-00-010-4659 | 12d | As required |
| 1670-00-753-3928 | Pad, energy dissipating, honeycomb 36- by-96- by 3-inches | 17 sheets |
| | Parachute: | |
| No NSN | Cargo, G-12 Reefed | 1 |
| 1670-00-216-7297 | Pilot, 68-in diam | 1 |
| 4030-00-678-8562 | Clevis, suspension, 3/4-inch (medium) | 1 |
| 5530-00-128-4981 | Plywood, 3/4-by-48-by-96-inch (box) | 4 sheets |
| 5530-00-914-5118 | Plywood, 1-by-48-by-96-inch | 4 sheets |
| 5510-00-220-6446 | 2-by 4-by 48-inch lumber | 4 |
| 7510-00-266-6710 | Tape, masking, 2-inch | As required |
| 8310-01-102-4478 | Thread, cotton, ticket number 8/7 | As required |
| | Webbing: | |
| 8305-00-268-2411 | Cotton, 1/4-inch, type I | As required |
| 8305-00-082-5752 | Nylon, tubular, 1/2-inch | As required |
| 8305-00-263-3591 | Type VIII | As required |
| 4020-00-240-2146 | Cord, nylon type III | As required |

SECTION III - RIGGING FOOD AND MEDICAL ITEMS IN QUADRUPLE A-22 CONTAINER FOR HIGH VELOCITY AIRDROP

PREPARING AND POSITIONING FOOD AND MEDICAL LOADS

5-21. Prepare and position food and medical items in accordance with Section II paragraphs 5-7 through 5-11 and paragraphs 5-13 through 5-19 and Table 5-3. Paragraph 5-12 will be replaced with the following steps.

FOOD ITEMS:

- a.** Place a 40- by 40-inch piece of honeycomb in the bottom of the box. Place food items into a tri-wall box. The box should have a base of approximately 43 by 43 inches and should be between 40 and 50 inches high. Heavy bulk food must be placed on the bottom of the box. The items must be placed so that the weight of the load is evenly distributed. Lighter items should then be placed around and on top of the heavy items. Place additional light items into the box so that the box is completely cubed out. Pad items with cellulose wadding or bubble wrap. Wrap items in shrink wrap and/or place additional honeycomb pieces inside box for protection.
- b.** Fill three additional boxes with food items.
- c.** Place and center the four boxes on top of the A-22 covers. Standard warehouse pallets may be rigged under the box for handling ease. If there are gaps between the boxes, fill the gaps with pieces of honeycomb.

MEDICAL ITEMS:

- d.** Place four 100 pound clothing/blanket bundles on each quadrant of the quadruple A-22. Fill any gaps with light non-fragile items. Shrink wrap or otherwise protect each group of four clothing/blanket bundles.
- e.** Shrink wrap or otherwise protect all four of the bundles together. Place one pre-configured box of medical supplies (specially packaged for airdrop) on each corner of the load and on top of the clothing/blanket bundles.

Table 5-3. Equipment Required for Rigging Food and Medical Items in Quadruple A-22 Container

| National Stock Number | Item | Quantity |
|-----------------------|--|-----------------------|
| 1670-01-162-2372 | Clevis, cargo, type V | 8 |
| 1670-00-587-3521 | Bag, cargo, A-22 | 4 |
| 1670-01-062-6302 | Sling, cargo, airdrop, 20-ft (2 loop), type XXVI nylon webbing | 2 |
| 1670-01-062-6303 | Sling, cargo, airdrop, 12-ft (2 loop), type XXVI nylon webbing | 4 |
| 1670-00-753-3928 | Pad, energy dissipating, honeycomb 36-by-96-by-3-inches 24-by-96-by-3-inches | 10 sheets 2 sheets |
| No NSN | Shrink wrap | As required |
| No NSN | Parachute: | |
| 1670-00-216-7297 | Cargo, G-12 Reefed | 1 |
| 4030-00-678-8562 | Pilot, 68-in diam | 1 |
| 4030-00-678-8562 | Clevis, suspension, 3/4-inch (medium) | 1 |
| 8310-01-102-4478 | Thread, cotton, ticket number 8/7 | As required |
| 8305-00-268-2411 | Webbing: Cotton, 1/4-inch, type I | As required |
| 8305-00-082-5752 | Nylon, tubular, 1/2-inch | As required |
| 8305-00-263-3591 | Type VIII | As required |
| 4020-00-240-2146 | Cord, nylon type III | As required |

Glossary

| | |
|---------------|--------------------------------------|
| AFB | Air Force Base |
| AFJMAN | Air Force Joint Manual |
| AFSOC | Air Force Special Operations Command |
| ALC | Airlift Logistics Center |
| AMC | Air Mobility Command |
| CB | center of balance |
| CDS | container delivery system |
| d | penny |
| DA | Department of Army |
| DC | Distric of Columbia |
| diam | diameter |
| FM | field manual |
| ft | foot/feet |
| HDRS | humanitarian daily rations |
| HUMRO | humanitarian releif operations |
| HQ | headquarters |
| HV | high velocity |
| IAW | in accordance with |
| in | inch |
| LCADS | low cost aerial delivery system |
| lb | pound |
| MREs | meals ready to eat |

| | |
|---------------|---------------------------------------|
| No | number |
| TM | technical manual |
| TO | technical order |
| TRADOC | US Army Training and Doctrine Command |
| TRIADS | tri-wall aerial delivery system |
| USA | United States of America |
| YD | yards |

References

- AFJ (I) 13-210/AR 59-4** Joint Airdrop Inspection Records, Malfunction Investigations and Activity Reporting. 1 May 1998.
- *AFMAN(I) 24-204/
TM 38-250** Preparing Hazardous Materials for Military Air Shipments. December 2001.
- **FM 4-20.102/NAVSEA
SS400-AB-MMO-010/
TO 13C7-1-5** Airdrop of Supplies and Equipment: Rigging Airdrop Platforms. 22 August 2001.
- FM 10-500-3/ TO 13C7-1-11
MARINE CORPS FMFM
7-47** Airdrop of Supplies and Equipment: Rigging Containers. 26 September 1996.
- TM 10-1670-276-23&P/
TO 13C5-29-2/NAVAIR 13-
1-29** Unit and Intermediate Direct Support (DS) Maintenance Manual (Including RepairParts and Special Tools List) for Parachute, Cargo Type: 26-ft Diam, High Velocity. 28 September 1990.
- TM 10-1670-281-23&P/TO
13C5-32-2/NAVAIR 13-1-32** Unit and Intermediate Direct Support (DS) Maintenance Manual (Including RepairParts and Special Tools List) for Parachute, Cargo Type: 64-ft Diam, models G-12D and G-12E. 1 October 1990.
- AFTO Form 22** Technical Order Publication Improvement Report
- DA Form 2028** Recommended Changes to Publication and Blank Forms. February 1974.
- DD Form 1748-1** Joint Airdrop Inspection Record (Container).
- *** Shipper's Declaration
for Hazardous Goods** Locally Procured Form.
- *AFMAN(I) 24-204/TM 38-250 has superseded AFJMAN 24-204/TM 38-250 (25 November 1994).**
- ** FM 4-20.102/NAVSEA SS400-AB-MMO-010/TO 13C7-1-5 has superseded FM 10-500-2/TO 13C7-1-5 (1 November 1990).**
- *** Shipper's Declaration for Dangerous Goods has superseded DD Form 1387-2 (February 1982).**

By Order of the Secretary of the Army and the Air Force:

PETER J. SCHOOMAKER
General, United States Army
Chief of Staff

Official:



JOEL B. HUDSON
Administrative Assistant to the
Secretary of the Army
0330314

LESTER L. LYLES
General, USAF
Commander, AFMC

JOHN P. JUMPER
General, USAF
Chief of Staff

DISTRIBUTION:

Active Army, Army National Guard, and U.S. Army Reserve: To be distributed in accordance with the initial distribution number 110929, requirements for FM 4-20.147.

PIN: 081115-001