

~~SECRET~~

MRT-4-046  
QM-66-072  
DRC-H-9331-002

PROJECT PANDORA (U)

Final Report

24 FEB 1977

THIS DOCUMENT HAS BEEN DOWNGRADED  
TO UNCLASSIFIED  
Per Director DARPA / Tio

~~EXCLUDED FROM AUTOMATIC DOWNGRADING~~  
~~DOD DIR 5200.10 DOES NOT APPLY~~

Prepared by  
Eugene V. Byron  
November 1966

~~SECRET~~

# 775

ABSTRACT

This is the final report on the Applied Physics Laboratory's contribution to Project PANDORA - specifically, aid in the implementation, and the evaluation of a microwave test facility at Walter Reed Army Institute of Research. An "expandable" conical horn transmitting antenna, and monitor dipole receiving antennas were designed for use in the anechoic chamber constructed by Emerson and Cuming, Inc. A mechanical field traversing mechanism was designed and constructed for the chamber evaluation, the microwave equipment was functionally assembled, and the completed facility was thoroughly evaluated. The evaluation included the measurement of power variations in the quiet zone with and without the sample container (with and without the test sample) in the required position, and the measurement of the power density in the quiet zone using the Microwave Associates high power TWT and the appropriate transmitting horn sections.

TABLE OF CONTENTS

<u>Section</u>	<u>Title</u>	<u>Page</u>
I	<u>INTRODUCTION</u>	1
II	<u>DESCRIPTION OF THE MICROWAVE FACILITY</u>	2
A	MICROWAVE ANECHOIC CHAMBER	2
B	MICROWAVE EQUIPMENT	3
C	TRANSMITTING HORN	4
D	POWER MONITORING	4
1	Transmitted Power Monitor	4
2	Standard Gain Horn Monitor	5
3	Monitor Dipole	6
E	SELECTION OF TRANSMITTING HORN SECTIONS	6
1	Design Frequency Range	6
2	Horn Sections for Higher Power Densities	8
F	DETERMINATION OF POWER DENSITY	8
III	<u>EVALUATION: PROCEDURE AND RESULTS</u>	9
A	MICROWAVE CHAMBER EVALUATION	10
B	EVALUATION OF THE TEST SAMPLE CONTAINER, AND THE TEST SAMPLE IN THE CONTAINER	13
1	Test Sample Container	13
2	Evaluation Procedure	13
3	Test Sample	14
C	POWER DENSITY MEASUREMENTS	15
D	CONCLUSION	16

~~SECRET~~

TABLE OF CONTENTS  
(continued)

<u>Section</u>	<u>Title</u>	<u>Page</u>
APPENDIX A	TRANSMITTING HORN, DESIGN AND TEST RESULTS	A1
APPENDIX B	SLEEVE DIPOLE ANTENNA	B1
APPENDIX C	FIELD TRAVERSING MECHANISM	C1

~~SECRET~~  
-iii-  
~~SECRET~~

LIST OF ILLUSTRATIONS

<u>Figure No.</u>	<u>Title</u>	<u>Page</u>
1	Microwave Anechoic Chamber	17
2	Microwave Anechoic Chamber - General Arrangement Drawing	18
3	Rack Arrangement of Microwave Equipment	19
4	Pandora Microwave Equipment - Functional Block Diagram	20
5	Expandable Conical Horn	21
6	Absolute Gain of Conical Horn	22
7	E Plane 3 db Beamwidth of Conical Horn	23
8	H Plane 3 db Beamwidth of Conical Horn	24
9	Typical E and H Plane Patterns of Conical Horn	25
10	High Power TWT Monitor - Meter Reading vs. Transmitted Power	26
11	Power Density per Watt Transmitted for Each Horn Section	27
12	Received Power Density, Monitor Channel No. 1	28
13	Monitor Dipoles	29
14	Change in Relative Amplitude for Various Fixed Angles vs. Frequency; Horn Sections D1 to D6	30
15	Change in Relative Amplitude for Various Fixed Angles vs. Frequency; Horn Sections D7 to D10	31
16	Typical Reflection from Chamber Walls	32

~~SECRET~~  
~~SECRET~~  
~~SECRET~~

LIST OF ILLUSTRATIONS  
(continued)

<u>Figure No.</u>	<u>Title</u>	<u>Page</u>
17	Chamber Evaluation - Frequency - 2.6 GHz	33
18	Chamber Evaluation - Frequency - 2.8 GHz	34
19	Chamber Evaluation - Frequency - 3.0 GHz	35
20	Chamber Evaluation - Frequency - 3.25 GHz	36
21	Chamber Evaluation - Frequency - 3.25 GHz (with Standard Gain Horn)	37
22	Chamber Evaluation - Frequency - 3.45 GHz	38
23	Chamber Evaluation - Frequency - 3.8 GHz	39
24	Field Perturbations Due to Sample Container	40
B1	Sleeve Dipole Antenna	B2
B2	"Gooseneck" Monitor Dipole	B3
B3	VSWR of Dipole Antennas	B4
C1	Field Traversing Mechanism	C2
C2	Wiring Diagram, Field Traversing Mechanism	C3

~~SECRET~~

~~SECRET~~

LIST OF TABLES

<u>Table No.</u>	<u>Title</u>	<u>Page</u>
1	Quiet Zone Volumes and Power Variations	11
2	Summary of Sample Container Perturbations	14
3	Measured versus Calculated Power Densities	15
A1	Transmitting Horn Dimensions	A3
A2	Measured versus Calculated Gain	A4
A3	Measured versus Calculated E & H Plane Beamwidths	A5

## I. INTRODUCTION

This is the final report on the contribution of the Johns Hopkins University Applied Physics Laboratory, to Project PANDORA - specifically, aid in the implementation and the evaluation of a microwave test facility at the Walter Reed Army Institute of Research, Forest Glen Section. APL's responsibilities were divided into roughly three areas: (1) aid in determining the suitability of the microwave equipment to be procured, and the functional assembly of this equipment (2) the design and fabrication of necessary specialized equipment, - transmitting horn, monitoring dipole antennas, a field traversing mechanism, etc., and (3) the evaluation of the microwave anechoic chamber, the calibration of the measurement equipment, and the test of the completed facility. The test and evaluation of the completed facility included the measurement of the power variations in the quiet zone of the anechoic chamber with and without the sample container (with and without the test sample) in the required position, and the measurement of the power density in the quiet zone.

In addition, a familiarization session was conducted for Army personnel scheduled to operate the facility. A companion report <sup>(1)</sup> describes the operational procedure, the procedure for determining the power requirements and which "add-on" section of the expandable conical horn to use for a desired power density, and a description of the monitoring equipment.

The commercially available microwave equipment was specified and purchased by the Air Force Avionics Laboratory (AFAL), Wright-Patterson AFB, Columbus, Ohio - the program managers. The microwave anechoic chamber was designed and constructed by Emerson and Cuming, Inc., Canton, Mass. The high power microwave traveling wave tube was designed and built by Microwave Associates, Burlington, Mass., with the associated power supplies furnished by Alto Scientific, Inc., Palo Alto, California.

---

(1)

"Operational Procedure for Project PANDORA Microwave Test Facility"  
APL/JHU Report MRT-4-045; (QM-66-071) dated October 1966 (U)

~~SECRET~~



## II. DESCRIPTION OF THE MICROWAVE FACILITY

The microwave test facility implemented at Walter Reed consists of a microwave anechoic chamber, an expandable conical transmitting horn attached to one end wall of the chamber, and the microwave control and monitoring equipment installed in four equipment racks which are housed in the control room adjacent to the transmission end of the chamber. Also, a standard gain horn power monitor, and two sleeve dipole monitoring antennas are installed in the microwave chamber.

The facility was designed to operate at S-Band, with conversion potential through X-Band, such that a suitable quiet zone - minimum dimensions, 3' wide x 2' high x 1' deep, for two test samples side by side - would be illuminated uniformly; a power density of  $2 \text{ mw/cm}^2 \pm 1.0 \text{ db}$  over the frequency band was the design goal, with a potential for a power density of  $10 \text{ mw/cm}^2$  over a reduced volume and a fixed frequency.

### A. MICROWAVE ANECHOIC CHAMBER

The microwave anechoic chamber (Eccosorb Anechoic Chamber No. 650) is approximately 15' wide by 15' high by 35' long. The proposed four foot cubic quiet zone is symmetric about a point 25 feet from the transmitting end wall, and equidistant between the floor, ceiling and side walls. Figure 1 is a photograph of the chamber; figure 2 is the general arrangement drawing, and also shows the mounting detail for the transmitting horn.

The design requirements for the chamber specified that the power variations should not exceed  $\pm .25 \text{ db}$  superimposed on the transmitted gain "droop" measured in the quiet zone with an absorber backed dipole over the frequency band of interest. As noted in Section III of this report, these values were not realized, and power "amplitude ripples" as great as  $\pm 1.0 \text{ db}$  were observed. The chamber evaluation showed that for the minimum quiet zone dimensions - 3' wide x 2' high x 1' deep, - power variations of

~~SECRET~~

~~SECRET~~

$\pm 1.75$  db were possible over the S-Band frequency range. When a standard gain horn was used as the field probe instead of the absorber backed dipole, considerable improvement was observed; amplitude ripples were less than  $\pm 0.25$  db. This is discussed further in Section III.

#### B. MICROWAVE EQUIPMENT

The microwave equipment is assembled in the four racks shown in figure 3. Equipment rack number one contains the Spectrum Analyzer R. F. and Display sections. Rack number two contains the auxiliary low power microwave generation and modulation equipment, and some ancillary equipment, in addition to the control panel for the field traversing mechanism. Rack number three contains the primary low-power microwave generation and modulation equipment, and the necessary monitoring and recording equipment. Rack number four contains the high power microwave amplifier and associated power supplies and R. F. power monitors.

The equipment in rack number two is not interconnected (nor is the spectrum analyzer). The interconnection of racks number three and four with the expandable conical horn is shown in figure 4 which is a functional block diagram of the microwave system. Also shown in this figure are the "downstream" power monitors in the anechoic chamber.

All of the equipment assembled in racks number two and three are commercial "off the shelf" units (traveling mechanism control panel excepted) and constitutes the best and most versatile, in terms of possible R. F. modulations, microwave equipment available. This was particularly necessitated by the unknown nature of the desired signal for an experimental facility. These units were specified and purchased by the program managers (AFAL). Compatability and suitability of this equipment was monitored by APL and the equipment was functionally assembled and tested at APL and delivered as a unit to Walter Reed.

The high power microwave amplification equipment in rack four was purchased under separate contract (from AFAL) to Microwave Associates and was delivered as a unit.

~~SECRET~~  
~~SECRET~~

### C. TRANSMITTING HORN

The transmitting horn characteristics were dictated by the dimensions of the quiet zone to be uniformly illuminated. This design rationale and the test results are discussed in Appendix A of this report. In order to provide a constant gain and beamwidth over the desired frequency band, "add-on" sections were provided as depicted in figure 5.

The first section of this "expandable" conical horn incorporates a rectangular to circular transition obviating the need for a separate rectangular to circular waveguide transition.

Gain measurements and antenna patterns were taken for each horn section at the center, and at the low and high ends of the S-Band frequency range. The results of these measurements are summarized in figures 6, 7, 8, and 9. Figure 6 shows the absolute gain of each of the sections across the frequency band. Also shown, is the design frequency range for each section. Figures 7 and 8 show the E and H plane 3 db beamwidth respectively, and figure 9 is a typical E and H plane pattern (section D3) in its design frequency range.

### D. POWER MONITORING

One of the prime requirements for the microwave test facility was the ability to accurately determine the power density in the quiet zone of the anechoic chamber and to observe the transmitted signal, within the limits afforded by commercially available test equipment.

Three monitoring channels were incorporated in the system, and several coupled outputs are available for observing signal wave form, either on an oscilloscope (detected outputs), or directly on the spectrum analyzer (see figure 4).

#### 1. Transmitted Power Monitor

To measure the transmitted power, two coaxial directional couplers and a thermistor mount were installed in the high power equipment rack (figure 4). The thermistor output is connected to the HP 431C power meter in rack number three. The loss in this coupled transmission path was measured

~~SECRET~~  
~~SECRET~~

over the S-Band frequency range. The resultant calibration was incorporated with the measured loss of the output cable and the waveguide to coax adapter on the transmitter horn, to plot the transmitted power curve shown in figure 10. This curve is a plot of corrected power meter reading versus transmitted power. Included in this figure is the legend for determining transmitted power from the corrected meter reading, and conversely, the method for setting the transmitted power by observing the meter reading. This figure in conjunction with figure 11 (Power Density per Watt Transmitted for Each Horn Section) can be used to determine the on boresight power density in the quiet zone. This is explained in greater detail in section II E.

## 2. Standard Gain Horn Monitor

The standard gain horn monitor (monitor number 1 in figure 4), is the primary "downstream" power density monitor. The gain deviation versus frequency curve of the standard gain horn, and the measured loss of the connecting cable and waveguide to coaxial adapter were incorporated into one frequency correction curve, shown in figure 12. This figure is a plot of the power density as a function of the corrected power meter reading. The power density thus measured is the power density at the position where the standard gain horn is placed in the chamber, and not the on boresight power density alluded to in the section above. It is possible to measure the power density in the anechoic chamber directly, only if the horn monitor can be physically placed at the desired position without interfering with the experiment in progress. If this is not possible, then the power density can be determined by extrapolating the measured power density, to the power density at any other position in the quiet zone by using the known gain-beamwidth characteristics of the transmitting horn section. In a similar fashion, the on boresight power density determined from the measured transmitted power can be extrapolated to any point in the quiet zone. The determination of power density for other than on boresight (and measured) conditions is discussed in Section II F.

~~SECRET~~  
~~SECRET~~

### 3. Monitor Dipoles

In addition to the standard gain horn monitor, two sleeve dipole monitors are available in the chamber for the observation of signal waveforms. These dipole monitors are shown in figure 13. The design dimensions and the measured results are discussed in Appendix B.

It was originally intended that these dipoles would be calibrated and used to measure the absolute power density at any position in the chamber. Unfortunately, the rather large amplitude ripples caused by the reflections from the chamber walls, precluded this possibility. (The standard gain horn integrates the ripples over its considerably larger area and, consequently, was substituted as the prime power density monitor.) However, since the dipoles are light-weight and easily movable, they were retained for signal waveform observation, and for the "gross measure" of power density. Since the two monitors have identical characteristics, by placing one at a region of known power density, and placing the other at any desired position, the power density at any position can be determined. This is a "gross measurement" because the amplitude ripples can cause an error as great as 2.0 db.

### E. SELECTION OF TRANSMITTING HORN SECTIONS

As stated previously, the microwave facility was designed such that a suitable quiet zone - minimum dimensions, 3' wide by 2' high by 1' deep for two test samples side by side - would be uniformly illuminated; a  $\pm 1.0$  db power variation in the quiet zone was the design goal. The quiet zone starts at a transmission length of 23.0' and is symmetric about the chamber horizontal and vertical axis.

#### 1. Design Frequency Range

As discussed in Appendix A, the quiet zone dimensions set the beamwidth characteristics of the transmitting horn; and a conical transmitting horn with "add-on" sections was designed to give maximum gain with the required beamwidth over the S-Band frequency range. Under these conditions, figure 11 shows the "design frequency range" for the appropriate

~~SECRET~~  
**SECRET**

sections (D1 through D6). This figure is a plot of power density (in  $\text{mw}/\text{cm}^2$ ) per watt transmitted -  $P_d/W$  - versus frequency for each of the horn sections at a transmission length of 23.0 feet. These curves are obtained by plotting the expression:

$$\frac{P_r}{A_r} \times \frac{1}{P_T} = \frac{G_T}{4\pi R^2} \equiv \frac{P_d}{W} \quad \text{as a function of frequency,}$$

where  $G_T$  is the measured gain of each of the transmitting horn sections, and  $R = 23.0$  feet is the transmission length. Thus  $\frac{P_r}{A_r} \times \frac{1}{P_T}$  is the power density per watt transmitted when  $P_T$  is the transmitted power.

It can be seen from figure 11 that, for the design frequency ranges,  $P_d/W$  is  $1.6 \times 10^{-2} \frac{\text{mw}/\text{cm}^2}{\text{watt}} \pm 10\%$ . For 250 watts of transmitted power - the recommended upper limit for continuous operation of the high power TWT - the power density is  $4.0 \text{ mw}/\text{cm}^2 \pm 10\%$ , which adequately meets the design goal of  $2 \text{ mw}/\text{cm}^2$  in the quiet zone.

Neglecting reflections in the chamber, the power density variation for angles off boresight is dependent upon the transmitting horn section used (the gain), the frequency, the angle, and the transmission length. The change in relative amplitude versus frequency for angles of 2, 4, and 6 degrees for each of the horn sections is shown in figures 14 and 15. The change in relative amplitude is defined as the maximum relative power amplitude at a designated frequency (the gain at boresight), minus the relative amplitude at the off boresight angle indicated, at the same frequency. The curves were obtained from the measured antenna patterns. Thus, the curves in figures 14 and 15 show the change in power density, for a fixed transmitted power and transmission length, at the angles indicated for each of the horn sections. For the minimum quiet zone dimensions, starting at a transmission length of 23', the maximum off boresight angle, in the H plane (vertical polarization) is:

$$\theta_H = \pm \tan^{-1} \frac{1.5}{23} = \pm 3.75^\circ, \text{ and in the E plane } \theta_E = \pm \tan^{-1} \frac{1}{23} = \pm 2.5^\circ.$$

It can be seen from figure 14 that in the design frequency range, the maximum change in relative amplitude is 0.75 db, which occurs for horn section D1 at frequency 4.0 GHz, (H plane, 4 degrees). Adding another 0.4 db due to the change in transmission length in the quiet zone (one foot deep), the total change in relative amplitude, and hence the change in power density for a fixed power transmitted, is 1.15 db ( $\approx \pm .6$  db) which is well within the  $\pm 1.0$  db goal set for the quiet zone.

For a quiet zone 4' wide x 3' high x 1' deep ( $\theta_H \approx \pm 5^\circ$ ,  $\theta_E \approx \pm 4.0^\circ$ ), the power density would be within  $\pm 1.0$  db (neglecting reflections). This was borne out by the chamber evaluation discussed in Section III.

## 2. Horn Sections for Higher Power Densities

To increase the versatility of the facility, additional "add-on" horn sections were designed to uniformly illuminate successively smaller quiet zone volumes with increased gain. Thus, at the upper end of the frequency band (3.95 GHz) horn section D10 will illuminate uniformly ( $\approx \pm .5$  db)

quiet zone large enough for a single test sample - 1.5' wide x 1' high x 1' deep. This can be determined from figure 15 where for D10 and  $\theta_H = \pm 2^\circ$ ,  $\theta_E = \pm 1^\circ$ ,  $\Delta A = .5$  db. At this frequency, D10 gives the maximum power density obtainable for the system. From figure 11, for horn section D10 at 3.95 GHz,  $P_d/W = 3.83 \times 10^{-2}$ , and the power required for a power density of 10 mw/cm<sup>2</sup> is:  $\frac{10}{3.83 \times 10^{-2}} = 260$  watts which is obtainable from the high power TWT in the system.

## F. DETERMINATION OF POWER DENSITY

As discussed in Section II D, the power density can be determined by direct measurement using the standard gain horn monitor and figure 12, if the monitor can be physically placed at the desired position. The on bore-sight power density can also be determined from the measured transmitted power and figure 11. From the discussion in Section E above, it can be seen that this value will be correct to better than  $\pm 1.0$  db for any point in the quiet zone in the design ranges.

~~SECRET~~

In using the larger section to illuminate the 3' wide by 2' high by 1' deep quiet zone, the power density at any position can be determined from the on boresight power density/watt transmitted curve (figure 11), and the  $\Delta A$  curves given in figures 14 and 15.

As an example, for horn section D10 with 200 watts transmitted at 3.95 GHz, the power density at boresight is  $P_d = P_d/W \times$  power transmitted.  $P_d/W = 3.83 \times 10^{-2}$  from figure 11, therefore,  $P_d = 7.66 \text{ mw/cm}^2$ . At the edge of the 3' quiet zone,  $\theta_H = \pm \tan^{-1} 1.5/23 = \pm 3.75^\circ$ . Interpolating from figure 15 for D10,  $\theta_H = \pm 3.75$ ;  $\Delta A$  is approximately - 2.25 db = 60% of the maximum amplitude, and the power density is approximately  $7.66 \times 60\% = 4.56 \text{ mw/cm}^2$  at the quiet zone edge.

In a similar manner, the on boresight power density can be determined from the measured power density at any point in the quiet zone. Actual values measured during a preliminary experiment are used as an example. The standard gain horn monitor was placed 2.5' off boresight in azimuth, and its meter reading was 2.4 dbm. From figure 12, at 3.2 GHz (the transmitted frequency) the frequency correction term is 2.2 db. Thus, the corrected meter reading is  $+ 2.4 \text{ dbm} + 2.2 \text{ db} = 4.6 \text{ dbm}$ , which (from figure 12) corresponds to a power density of  $3.1 \text{ mw/cm}^2$  at the point of measurement. The monitor horn position gives a  $\theta_H = \pm \tan^{-1} 2.5/23 = \pm 6.1^\circ$ , and from figure 14 for  $\theta_H = 6^\circ$  and horn section D6 (the horn section used)  $\Delta A = 1.9 \text{ db} = 65\%$ . Therefore, the on boresight power density is  $3.1 \text{ mw/cm}^2 \times \frac{1}{65\%} = 4.78 \text{ mw/cm}^2$ . For this experiment, the measured transmitted power (210 watts) gives an on boresight power density of  $4.72 \text{ mw/cm}^2$  (from figure 11) which is in good agreement with the above calculated value ( $4.78 \text{ mw/cm}^2$ ).

### III. EVALUATION: PROCEDURE AND RESULTS

The evaluation of the microwave test facility was divided in three phases: (1) the evaluation of the reflection from the walls and ceiling of the

~~SECRET~~  
~~SECRET~~



empty microwave chamber as measured with an absorber backed dipole and a standard gain horn, (2) the measurement of the reflections from a single sample container (both occupied and unoccupied) in the quiet zone and (3) the measurement of the power density in the chamber using the high power source and the various horn sections.

#### A. MICROWAVE CHAMBER EVALUATION

The results of the evaluation of the microwave anechoic chamber are summarized in Table I. It can be seen from this tabulation, that for the required minimum quiet zone dimensions - 3' Wide x 2' High x 1' Deep - a total power variation of  $\pm 1.75$  db is possible over the frequency band of interest. At selected frequencies, adequate quiet zones with  $\pm 1.25$  db variations are possible. The measurements, performed with an absorber backed dipole, indicate that the power variations are primarily due to "amplitude ripples" caused by reflections from the chamber walls. Maximum ripples as great as  $\pm 1.0$  db were observed. Figure 16 is a typical example of the power variation due to reflections. This data is for a 25' transmission length at  $F = 3.25$  GHz.

The values obtained with a standard gain horn at 3.25 GHz (gain = 16.5 db) are also shown in Table I, (from figure 21) as an example of the optimistic conclusions resulting from the use of a large area receiving antenna. The horn integrates the reflected ripples over a receiving area considerably larger than that of the dipole. Maximum ripples as observed with the standard gain horn were less than  $\pm 0.25$  db.

The chamber was evaluated by taking horizontal cuts, through the 4 foot cubic quiet zone which is centered equidistant between the side walls, and the floor and ceiling; a distance 25.0' from the transmitting end wall. The horizontal cuts extending  $\pm 2.0'$  from this quiet zone center, were taken at elevation increments of  $\pm 1.0'$ ,  $\pm 1.5'$ , and  $\pm 2.0'$  for each transmission length increment of  $\pm 1.0'$ ,  $\pm 1.5'$ , and  $\pm 2.0'$  from the 25.0' center point. These measurements were repeated at each of the six different frequencies in the design range of each of the horn sections. Relative power as a function of horizontal distance was recorded on an X-Y recorder, equipped with a roll chart adapter, for each of the measurement increments.

**TABLE I**  
**Quiet Zone Volumes and Power Variations**

Quer Sect	Volume Dimensions for Power Variations of:					
	+1.0db	+1.25db	+1.5db	+1.75db	+2.0db	≥+2.25db
6GHz (D6)	None	None	2'Wx2'Hx3'D	<u>4'Wx3'Hx1'D</u> 3'Wx3'Hx3'D	4'Wx4'Hx1'D 4'Wx3'Hx2'D 4'Wx2'Hx3½'D 3'Wx4'Hx2'D	4'Wx4'Hx4'D (2.75db)
8GHz (D5)	2'Wx3'Hx1'D	<u>4'Wx3'Hx1'D</u> 3'Wx2'Hx2'D 2'Wx3'Hx2'D 2'Wx4'Hx½'D	4'Wx3'Hx2'D 3'Wx4'Hx1'D 3'Wx3'Hx3½'D 2'Wx4'Hx2'D	4'Wx3'Hx3'D 3'Wx4'Hx3½'D 3'Wx3'Hx4'D 2'Wx4'Hx4'D	4'Wx4'Hx4'D	
10GHz (D4)	3'Wx2'Hx½'D	<u>4'Wx2'Hx1'D</u> 3'Wx3'Hx1'D 3'Wx2'Hx3'D	4'Wx3'Hx1'D 3'Wx3'Hx2'D 3'Wx2'Hx4'D 2'Wx4'Hx2'D	4'Wx3'Hx2'D 3'Wx4'Hx3½'D 3'Wx3'Hx4'D	4'Wx4'Hx1'D 3'Wx4'Hx4'D	4'Wx4'Hx4'D (2.5db)
12.5GHz (D3)	<u>3'Wx2'Hx1'D</u>	4'Wx2'Hx2'D	4'Wx3'Hx1'D 4'Wx2'Hx3'D 3'Wx2'Hx3½'D	4'Wx4'Hx1'D 4'Wx3'Hx3'D 4'Wx2'Hx4'D 3'Wx3'Hx4'D	4'Wx4'Hx2'D 4'Wx3'Hx4'D 3'Wx4'Hx3'D	4'Wx4'Hx4'D (2.25db)
15GHz (D3) Standard Gain Horn	<u>4'Wx3'Hx1'D</u> 3'Wx2'Hx2'	4'Wx4'Hx1'D 4'Wx3'Hx3'D Many others	Great many options	4'Wx4'Hx4'D		
18GHz (D2)	None	None	2'Wx4'Hx1'D 2'Wx2'Hx2'D	<u>3'Wx4'Hx1'D</u> 3'Wx2'Hx3½'D 2'Wx4'Hx2'D 2'Wx3'Hx4'D	4'Wx4'Hx2'D 4'Wx2'Hx3'D 3'Wx3'Hx4'D	4'Wx4'Hx4'D (2.25db)
20GHz (D1)	2'Wx2'Hx½'D	3'Wx2'Hx½'D 2'Wx3'Hx2'D	<u>4'Wx2'Hx1'D</u> 3'Wx2'Hx3'D 2'Wx3'Hx4'D	4'Wx4'Hx½'D 4'Wx3'Hx4'D	4'Wx4'Hx4'D	

= Width      H = Height      D = Depth

- Notes:
- (1) All quiet zone volumes start at a transmission length of 23 feet and are symmetric about the chamber width and height center points.
  - (2) Underlined are the volumes with minimum variations whose dimensions are ≥ minimum required values (3'Wx2'Hx1'D)

~~SECRET~~

of missing "worst point" cases, it is felt that the very large number of data points measured represents a good statistical sampling, and the conclusions summarized in Table I are representative of the chamber behavior.

## B. EVALUATION OF TEST SAMPLE CONTAINER AND TEST SAMPLE IN THE CONTAINER

### 1. Test Sample Container

Tests were conducted with a single test sample container in the quiet zone. For the container having no microwave absorbing liner, fairly large amplitude ripples resulted (greater than  $\pm 5.0$  db). With the container almost completely lined with a microwave absorber (the "radiation window" excepted), these variations are reduced to approximately  $\pm 3.5$  db. Removing the plexiglass back that was on the container (the container is irradiated from the back) and replacing it with a thin plexiglass back (1/16" thick) further reduced these variations to approximately  $\pm 2.5$  db. By absorber lining certain braces that are within the radiation window (and cannot be removed), the perturbations are reduced still further, to approximately  $\pm 2.0$  db, however, portions of the radiation window are blocked. In any event, the test sample in the container perturbs the field in some different manner and the question arises as to what constitutes a valid set of measurements: the sample and container immersed into an unperturbed field, or the sample placed in an unperturbed field within the container (if this were possible). In either case (the test sample and container, or the sample alone), complex multiple reflections result.

Consideration should be given to the possibility of constructing a suitably lossy microwave container with a radiation window of the desired dimensions.

### 2. Evaluation Procedure

The evaluation of the test sample container in the microwave chamber was performed by mounting the container in the center of the four foot cubic quiet zone (at a transmission length of 25.0 feet) on the horizontal traversing mechanism. A monitor dipole was placed at a transmission length of 23.0' on the horizontal and vertical center point. Received power was recorded as a function of the horizontal traverse of the container in the quiet

zone. The dipole was then moved toward the container in 3-inch increments and the measurement repeated. This procedure was repeated for several different elevations of the monitor dipole and several different frequencies. The test sample container was moved behind the dipole monitor, rather than the monitor being moved in front of the container, because, in the latter case, the traversing mechanism would "shadow" the container. Typical results of the container evaluation are shown in figure 24.

To mount the container at the proper elevation level, the traversing mechanism was fitted with an absorber pedestal, upon which the container was placed. The pedestal by itself (and the traversing mechanism) was evaluated as described above with negligible perturbations of the R. F. field resulting.

### 3. Test Sample

The evaluation of a single test sample in the test sample container was performed in a manner identical to the procedure described above. Results of these tests show that the sample in the container does not greatly increase the magnitude of the field perturbations over those observed for the container alone -  $\pm 2.88$  db versus  $\pm 2.63$  for the two cases respectively - however, the phase of the reflections is changed such that where a maximum was observed without the test sample, a minimum might now exist. Table II, below, is a summary of the evaluation of the test sample and the test sample container.

TABLE II

<u>Summary of Sample Container and Sample-in-Container Measurements</u>	
<u>Test Condition</u>	<u>Field Variation</u>
A. Sample Container Alone	<u>(Worst Case*)</u>
Absorber Lined Container (3/8' plexiglass back)	$\pm 3.63$ db
" " " (no back)	$\pm 4.88$ db
" " " (1/16" plexiglass back)	$\pm 2.63$ db
B. Sample in Sample Container	
Absorber Lined Container (1/16" plexiglass back)	$\pm 2.88$ db
C. Sample Alone**	$\pm .88$ db

\* Worst Case = greatest maximum to greatest minimum power variation in the quiet zone, for all positions of dipole monitor (see figure 24).

\*\* Perturbations due to Sample movement alone, container and dipole monitor stationary.

C. POWER DENSITY

The final evaluation phase of the microwave test facility was the measurement of the power density in the quiet zone, utilizing the complete microwave chain.

The power density was measured with the standard gain horn monitor as outlined in Section II F, for various frequencies, and for values of transmitted power between 200 and 300 watts with the appropriate horn sections. These measured values were compared with the power density calculated from the measured transmitted power and the gain of the horn sections. The results are summarized in Table III.

TABLE III

Measured versus Calculated Power Densities

Freq. (GHz)	Tx. Horn Section	Tx. Horn Gain	Measured Tx. Power (Watts)	Calc. Power Density -mw/cm <sup>2</sup> ( $P_T G_T / 4\pi R^2$ )	Measured Power Density mw/cm <sup>2</sup>	$\Delta =$ Calc.- Meas.
2.6	D6	99.6	228	3.40	3.70	-0.30
2.7	D6	105.0	226	3.55	3.90	-0.35
2.7	D5	91.2	220	3.0	3.0	0.00
2.8	D5	95.6	216	3.09	3.2	-0.11
2.9	D5	102.0	210	3.20	2.9	+0.30
2.9	D4	89.0	236	3.14	2.85	+0.29
3.0	D4	93.5	234	3.27	3.1	+0.17
3.1	D4	100.0	232	3.47	3.35	+0.12
3.2	D3	93.5	226	3.16	3.0	+0.16
3.3	D3	100.0	232	3.47	3.45	+0.02
3.4	D2	91.2	232	3.17	3.0	+0.17
3.6	D2	102.0	236	3.61	3.6	+0.01
3.6	D1	89.0	245	3.27	3.6	-0.33
3.7	D1	95.6	260	3.71	3.6	+0.11
3.8	D1	100.0	278	4.16	4.15	+0.01
3.9	D1	105.0	250	3.93	4.0	-0.07
3.95	D1	110.0	250	4.12	4.35	-0.23
4.0	D1	112.0	250	4.19	4.25	-0.06

NOTE: For these measurements R = 24.0'

~~SECRET~~

D. CONCLUSION

The microwave equipment at the Walter Reed facility is capable of producing a power density of approximately  $4.0 \text{ mw/cm}^2$  in a quiet zone adequate for two test samples side-by-side (3'W x 2'H x 1'D) over the S-band frequency range, with a transmitted power of 250 watts - the recommended upper limit for continuous operation of the high powered traveling wave amplifier.

For reduced quiet zone volumes, a power density of  $10 \text{ mw/cm}^2$  is possible.

When evaluated with an absorber backed dipole, total power variations of  $\pm 1.75 \text{ db}$  were observed in the 3'W x 2'H x 1'D quiet zone over the S-Band frequency range, primarily due to reflections from the chamber walls ( $\pm 1.0 \text{ db}$ ). Using a standard gain horn as the field probe reduces the observed "ripples" to less than  $\pm 0.25 \text{ db}$ .

For a single test sample in an absorber lined test sample container, field variations of  $\pm 2.63 \text{ db}$  were measured. The movement of the sample alone produced variation of  $\pm 0.88 \text{ db}$  in the power measured with the dipole antenna.

~~SECRET~~

~~SECRET~~

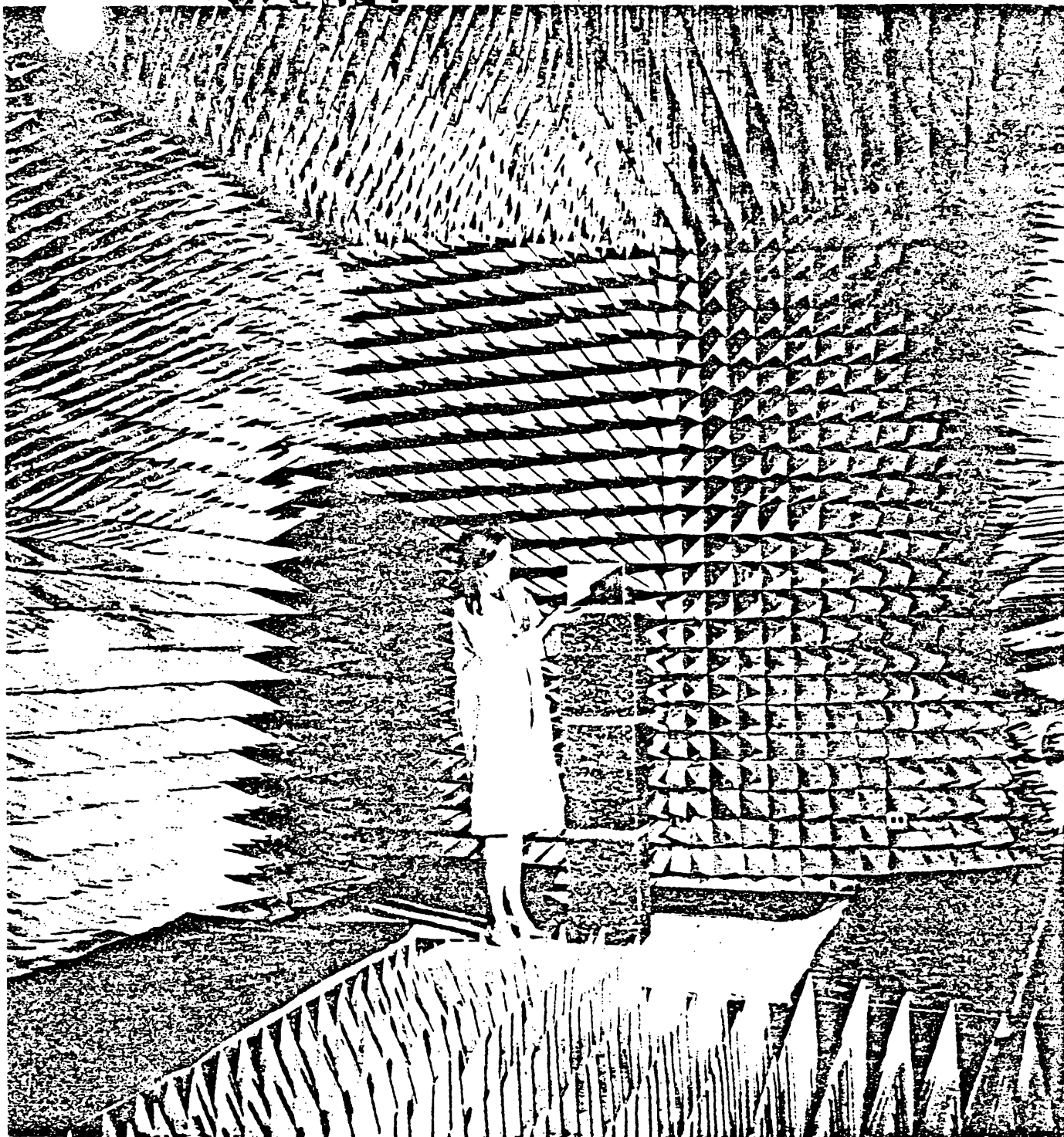
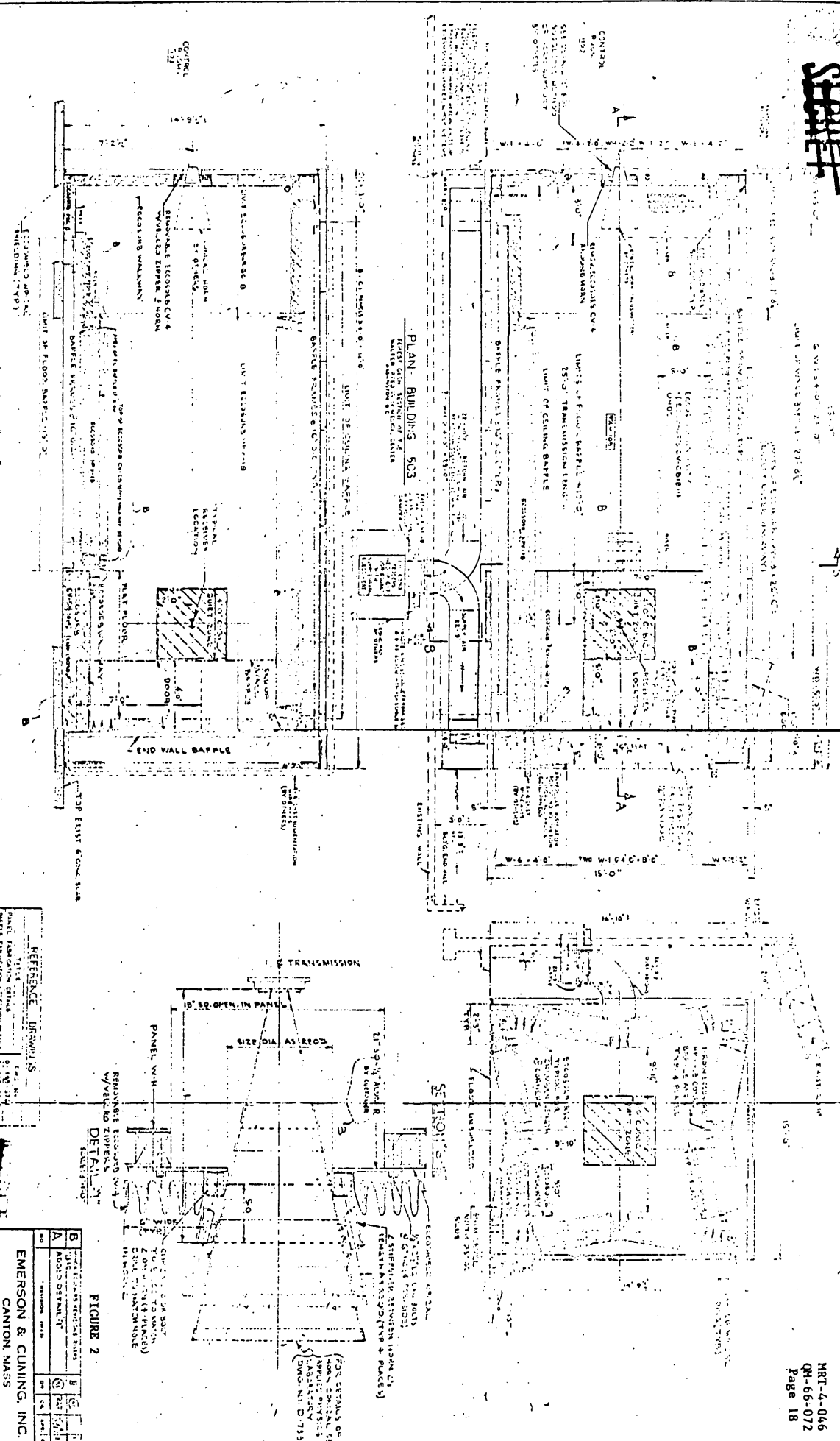

Fig. 1 MICROWAVE ANECHOIC CHAMBER

~~SECRET~~  
~~SECRET~~  
~~SECRET~~

2014-07-23 09:27:00  
 2014-07-23 09:27:00  
 2014-07-23 09:27:00



REFERENCE DIMENSIONS

Panel Fabrication Detail	2014-07-23
Panel Fabrication Section Detail	2014-07-23
Field Fabrication Detail	2014-07-23
Field Fabrication Section Detail	2014-07-23

FIGURE 2

EMERSON & CUNNING, INC.		CANTON, MASS.	
ECOLOGIC ANECHOIC CHAMBER			
GENERAL ARRANGEMENT			
No. 650			
DATE: 2014-07-23			



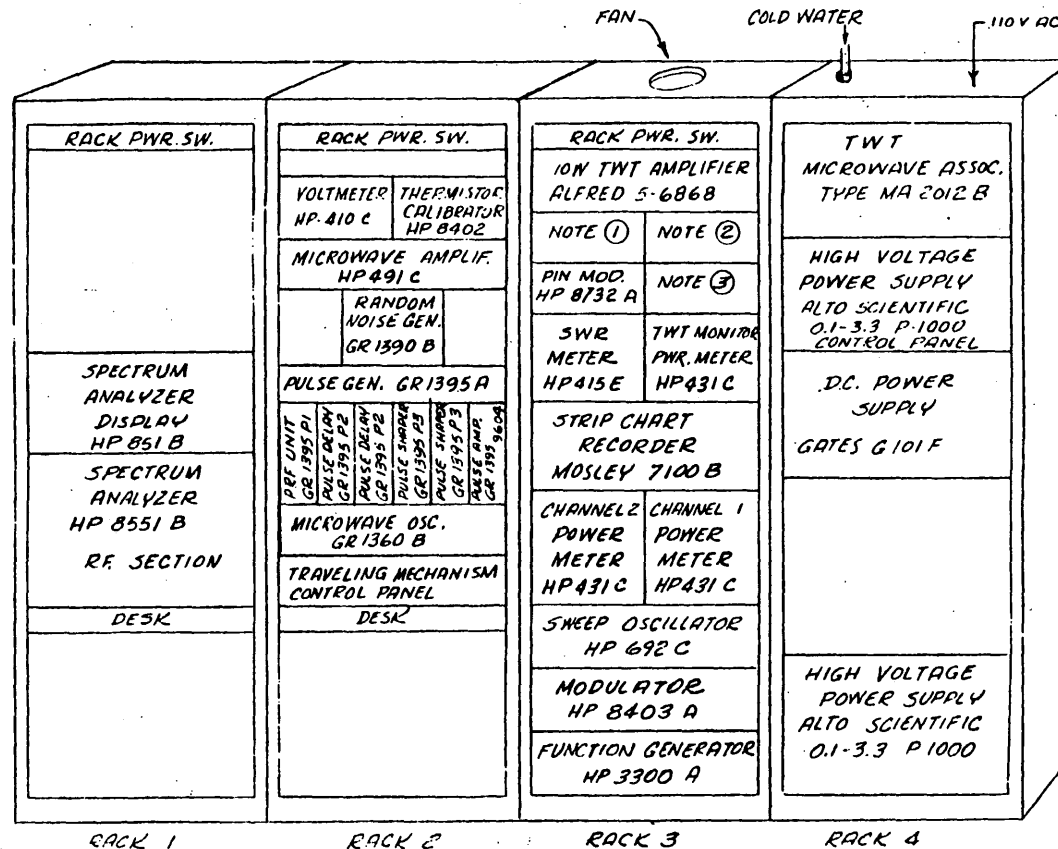

FIGURE 3  
BACK ARRANGEMENT OF  
PANDORA MICROWAVE EQUIPMENT

~~SECRET~~

~~SECRET~~

NOTE ① PANEL CONTAINS SWITCHES WHICH CONNECT VARIOUS MONITORED FUNCTIONS TO THE STRIP CHART RECORDER. BEHIND PANEL, BAND PASS FILTER (HP 8431A), 20db DIRECTIONAL COUPLER (HP 777D), 10db FIXED ATTEN. (WEINCOEL I-10N), ITAL DETECTOR (HP 423A).  
NOTE ② ALFRED 5-686B OUTPUT VARIABLE ATTENUATOR (NARDA 79E).  
NOTE ③ HP 692C SWEEP OSC. OUTPUT VARIABLE ATTENUATOR (NARDA 79E).

MRT-4-046  
QM-66-072

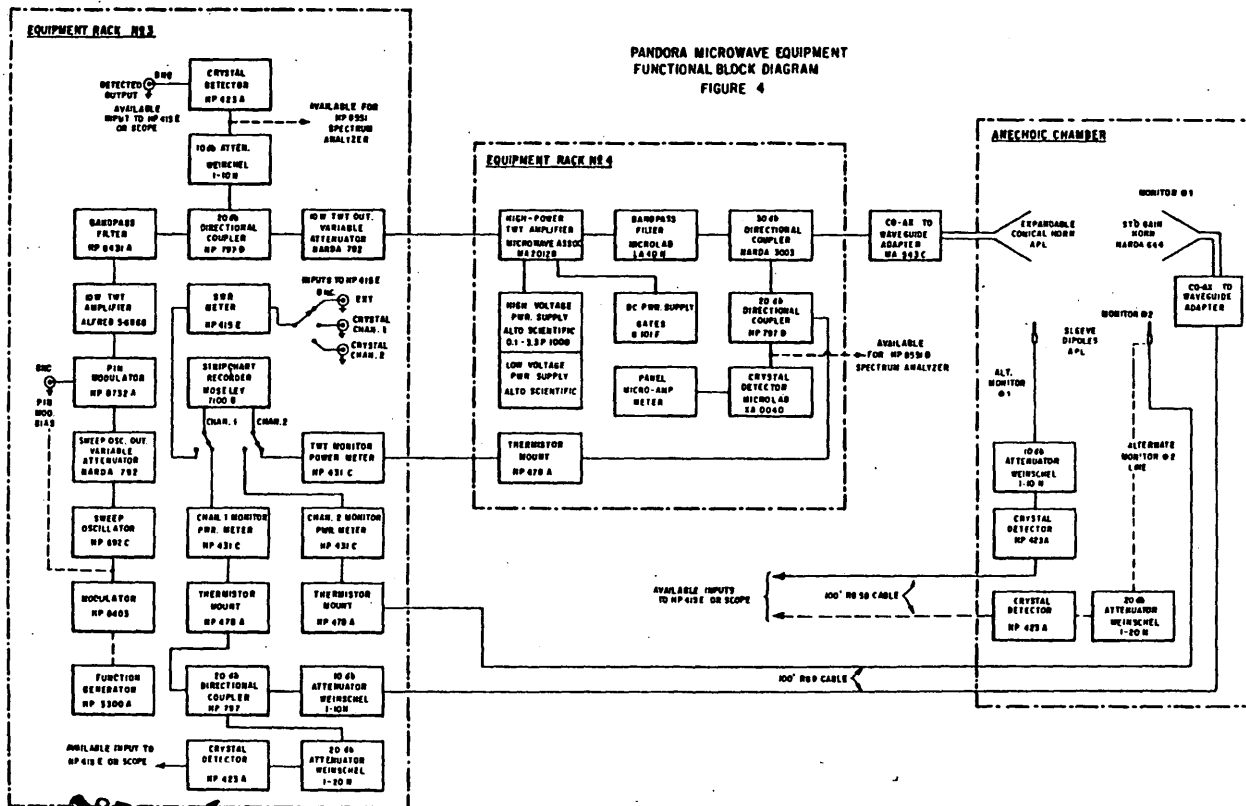

~~SECRET~~

~~SECRET~~

MRT-4-046  
QM-66-072  
Page 20

~~SECRET~~

DO NOT SCALE

MDT-4-046  
QM-66-072  
Page 21

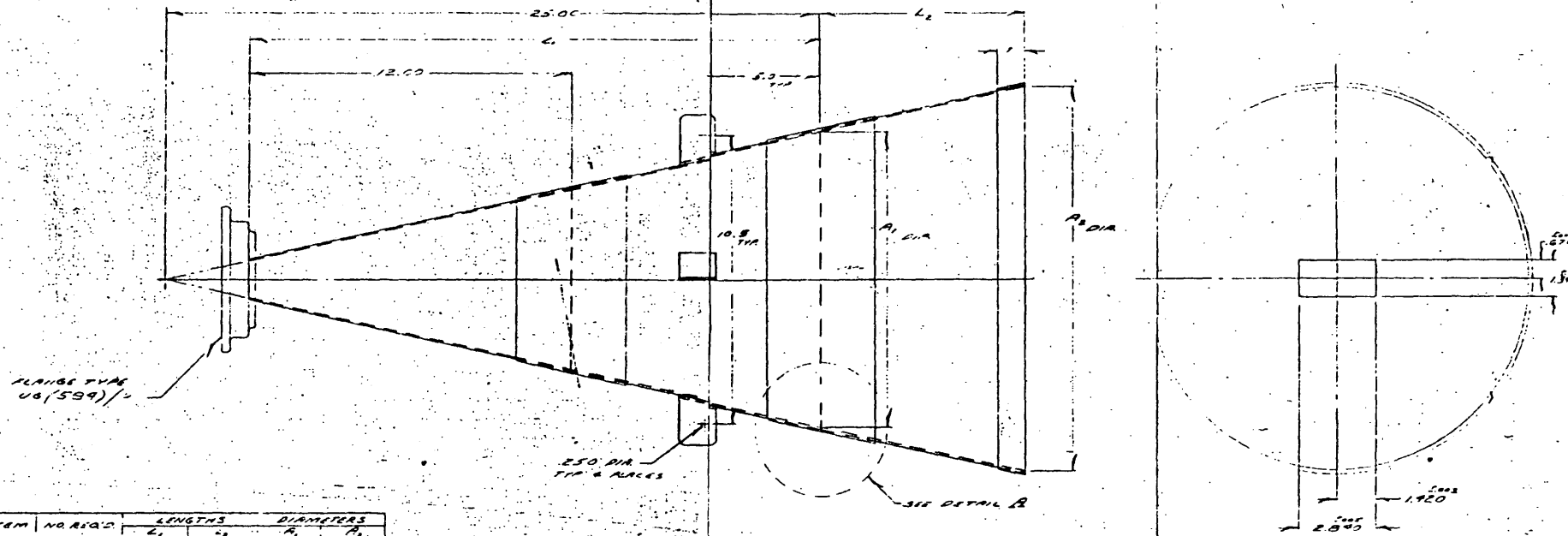

ITEM	NO. REQ'D	LENGTHS		DIAMETERS	
		L <sub>1</sub>	L <sub>2</sub>	R <sub>1</sub>	R <sub>2</sub>
A	1	21.07	"	10.25	"
B	1	8.25	"	10.25	11.75
C	1	5.25	"	"	13.00
D	1	7.50	"	"	14.00
E	1	10.25	"	"	15.25
F	1	14.00	"	"	16.75
G	1	17.25	"	"	18.25
H	1	21.50	"	"	20.00
I	1	26.75	"	"	22.25
J	1	31.75	"	"	25.00

CONSTRUCTION NOTES

- FABRICATE HORN SEGMENTS FROM .050 THICK ALUMINUM BY SPOT WELDING TECHNIQUE. ITEM A MAY BE CONSTRUCTED IN TWO SECTIONS PROVIDING HORN WITH FLANGE UG(594)/V IS NO LESS THAN 12.00 L<sub>1</sub>.
- ATTACH FLANGE VIA "HELL-ARC" WELDING TECHNIQUE METHOD.



DETAIL B  
FULL SCALE  
SHOWING METHOD OF FABRICATING  
AND ATTACHING CONICAL SECTIONS

INSTALL #8-32NC-2  
PERM SELF-CLINCHING STUDS  
TYPE B STUDS EQUALLY  
SPACED AROUND EACH OF  
EACH HORN SEGMENT ITEM S  
B THROUGH J

~~SECRET~~  
~~SECRET~~

DATE	BY	DESCRIPTION	CHECK	APPROV
FIGURE 5				
HORN CONICAL				
APPLIED PHYSICS LABORATORY				
TOLERANCE-EXCEPT AS NOTED			DIMENSIONAL	
FRACTIONAL			DECIMAL	
ANGULAR			RADIUS	
HOLE			D	
HOLE			73828	

~~SECRET~~

← → INDICATES FREQUENCY RANGES FOR  
3'W x 2'H x 1'D QUIET ZONE

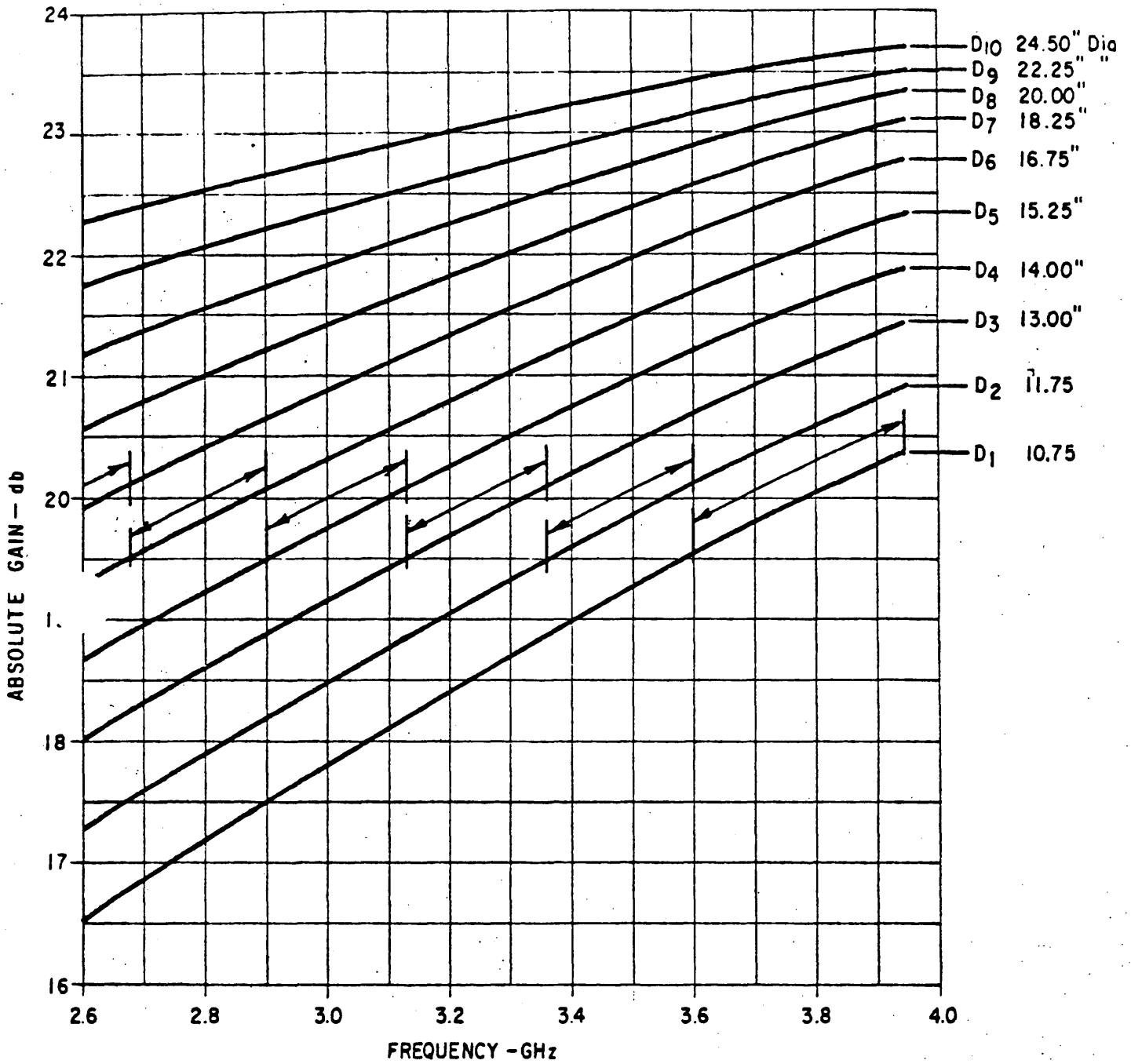

Fig.6 ABSOLUTE GAIN, EXPANDABLE CONICAL HORN

~~SECRET~~  
~~SECRET~~

~~SECRET~~

← → INDICATES FREQUENCY RANGES FOR  
3'W x 2'H x 1'D QUIET ZONE

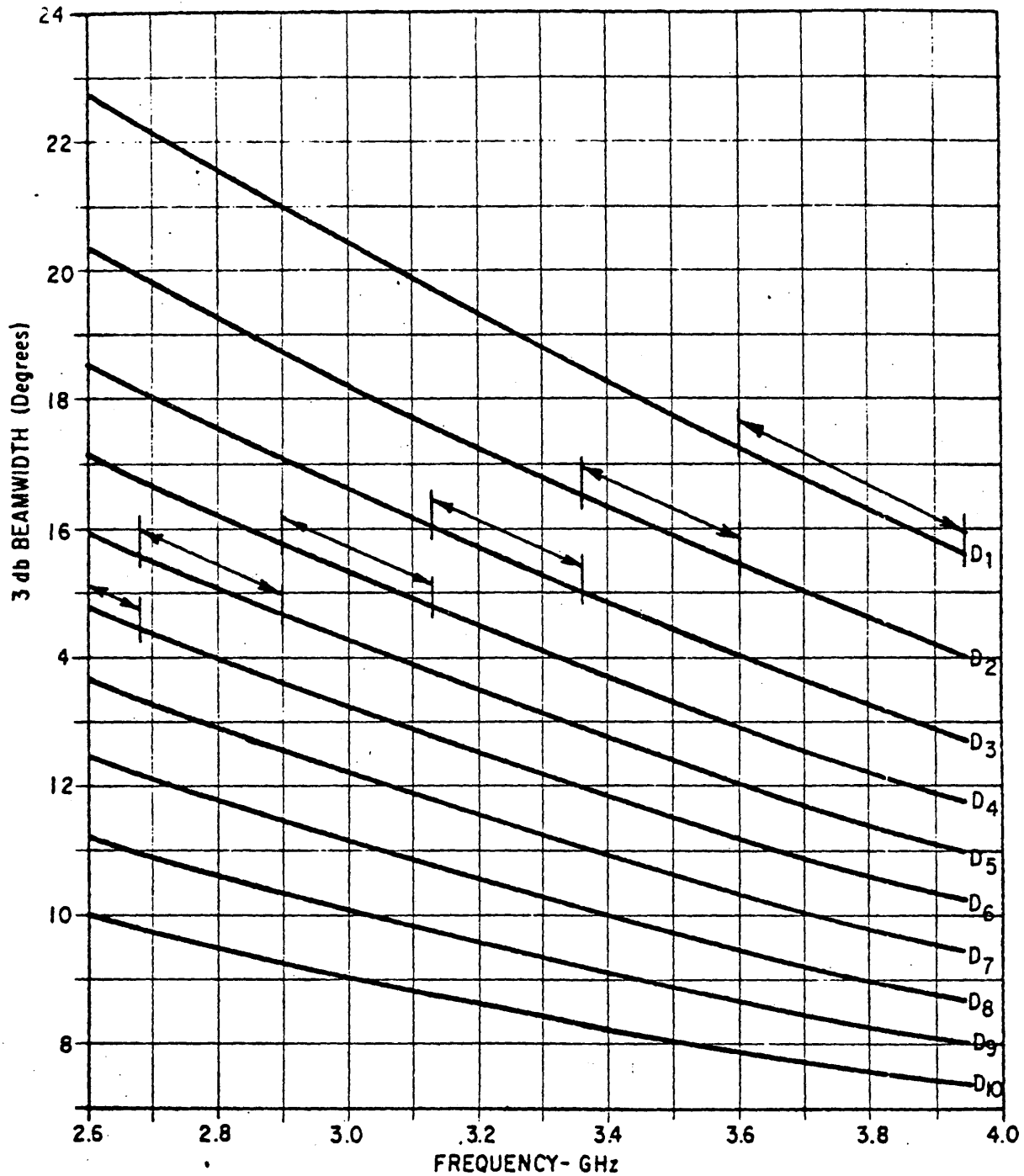

Fig.7 E PLANE 3db BEAMWIDTH, EXPANDABLE CONICAL HORN

~~SECRET~~  
~~CONFIDENTIAL~~

~~SECRET~~

← → INDICATES FREQUENCY RANGES FOR  
3'W x 2'H x 1'D QUIET ZONE

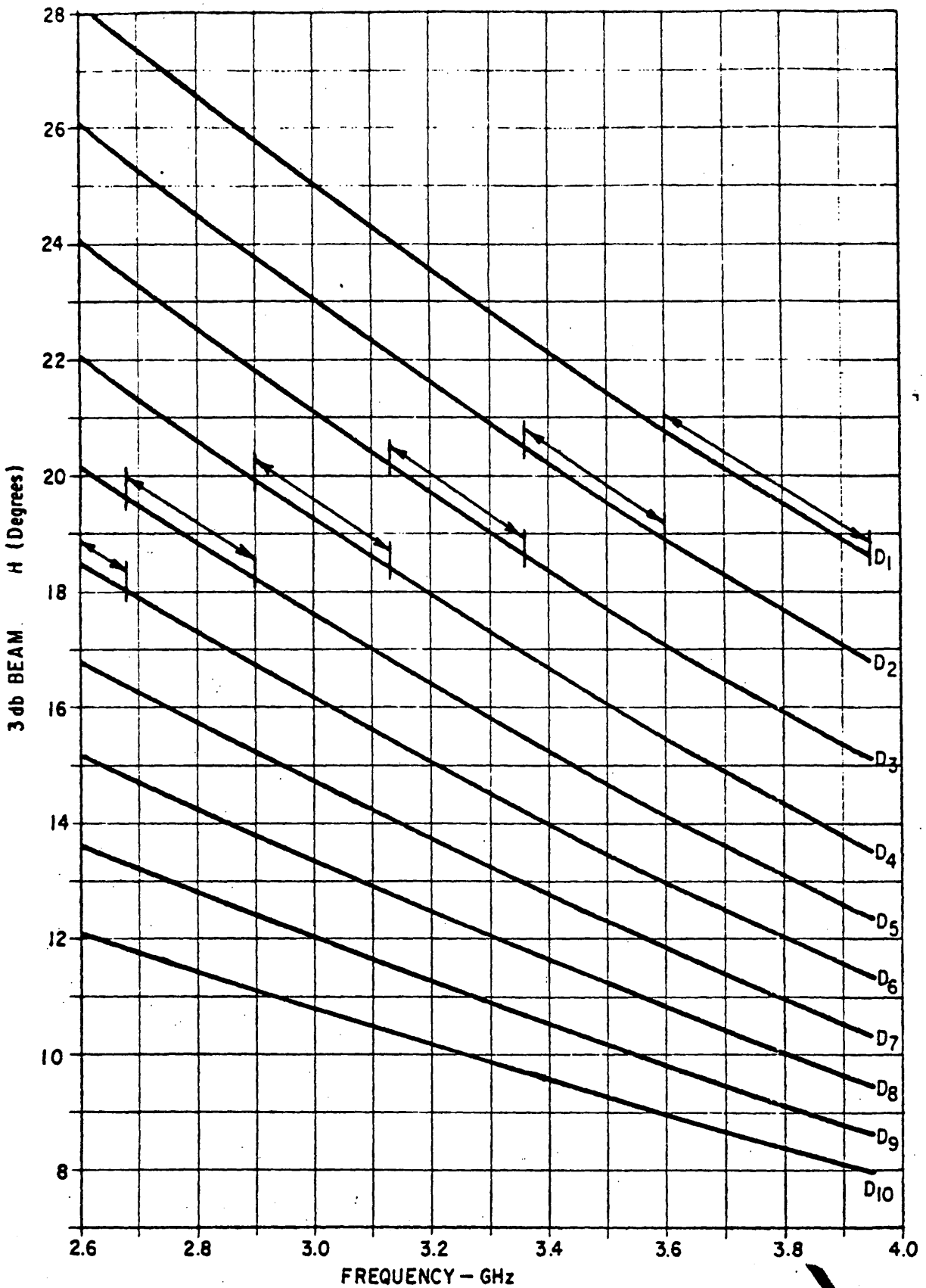
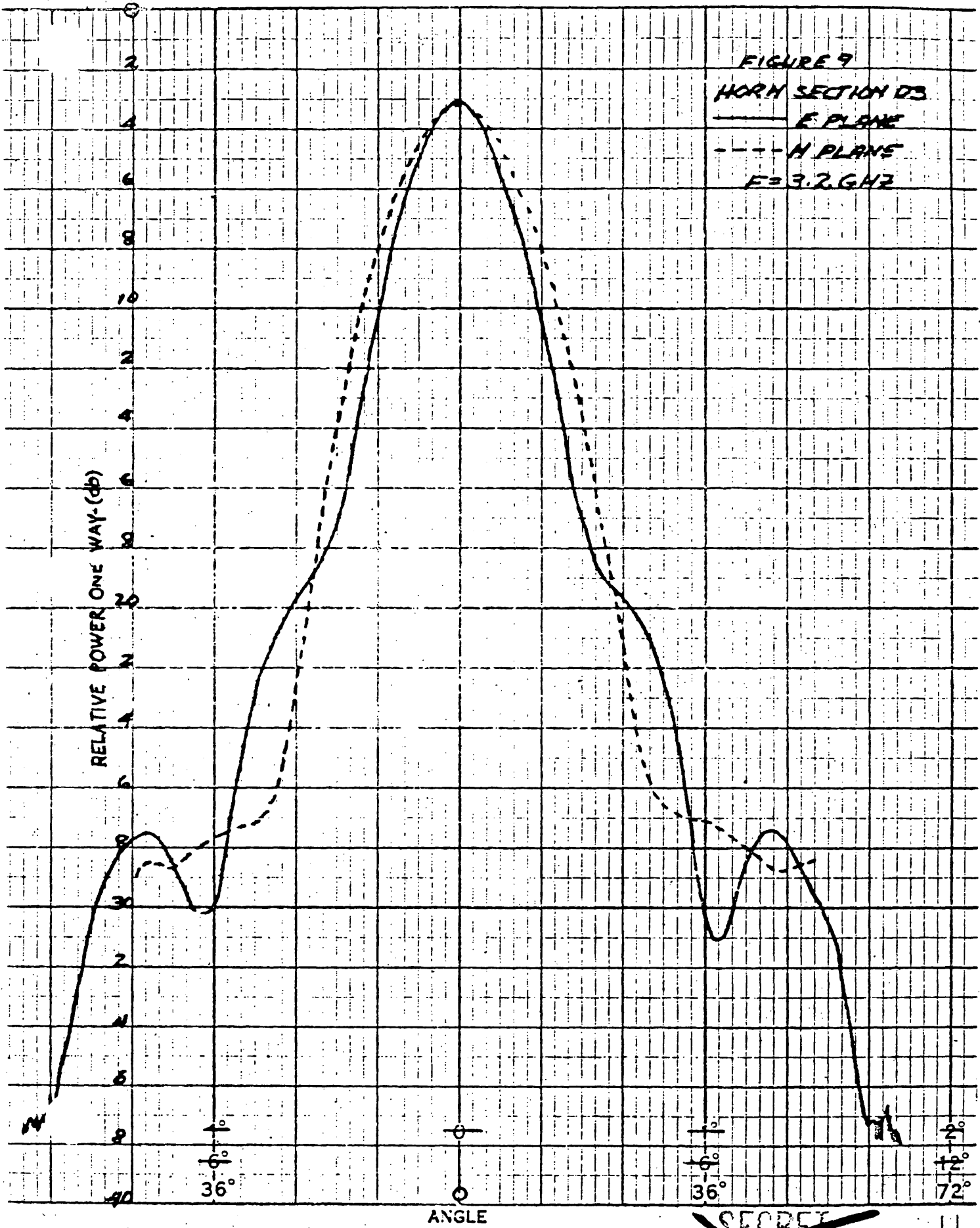

Fig. 8 H PLANE 3db BEAMWIDTH, EXPANDABLE CONICAL HORN

~~SECRET~~



~~SECRET~~

Fig.10 HIGH POWER TWT MONITOR - METER READING Vs TRANSMITTED POWER

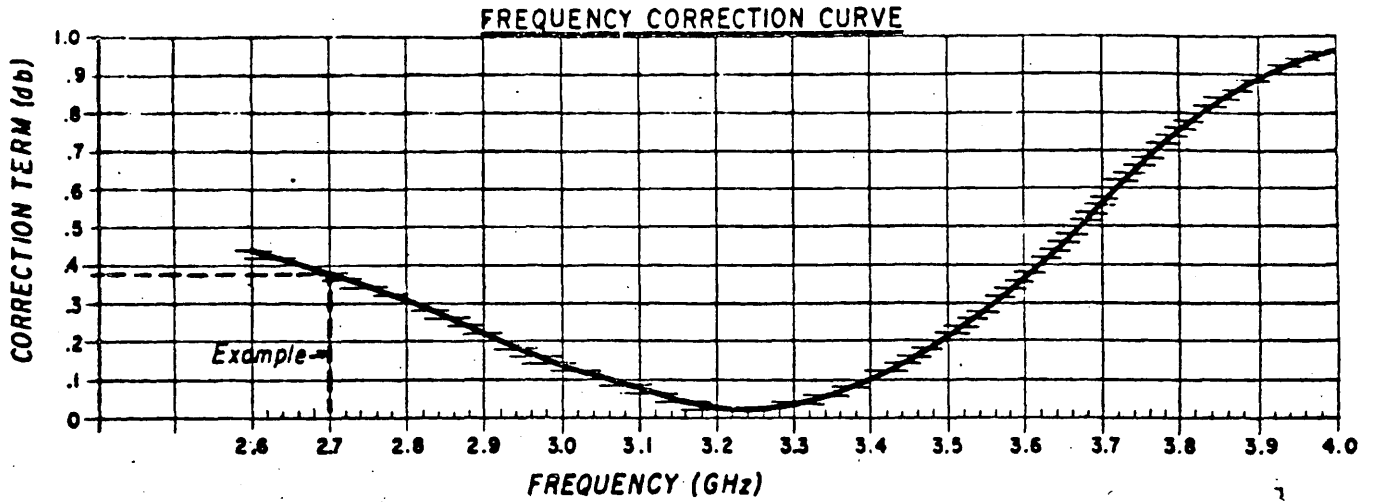

TO MEASURE TRANSMITTED POWER:

ADD CORRECTION TERM TO TWT MONITOR POWER METER READING.

Example: AT 2.7 GHz, THE CORRECTION TERM = .38

POWER METER READING = 2.00

CORRECTED METER READING 2.38 dbm  $\approx$  140 Watts  $P_T$

TO SET TRANSMITTED POWER:

SUBTRACT CORRECTION TERM FROM CORRECTED METER READING WHICH CORRESPONDS TO DESIRED POWER. ADJUST POWER TO OBTAIN THIS VALUE ON TWT MONITOR POWER METER.

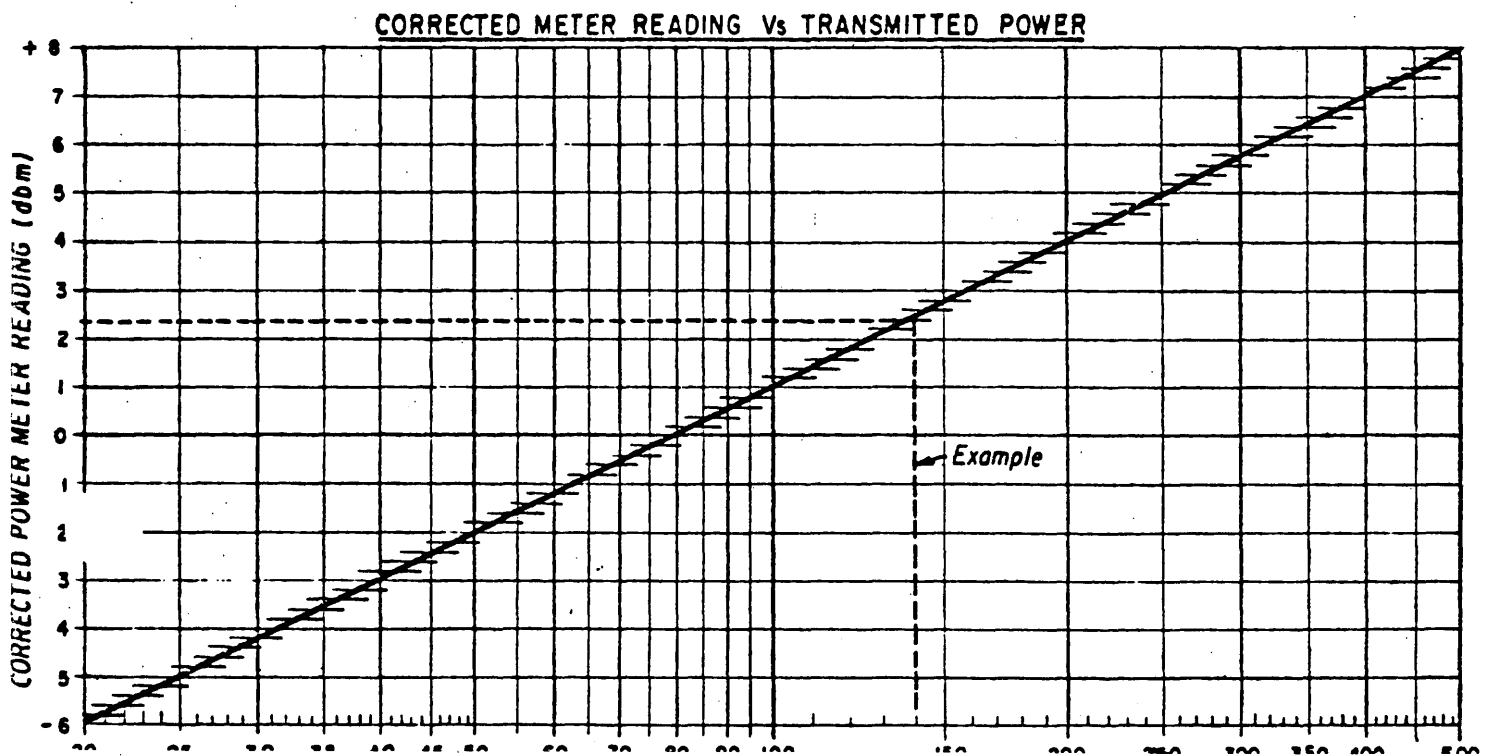
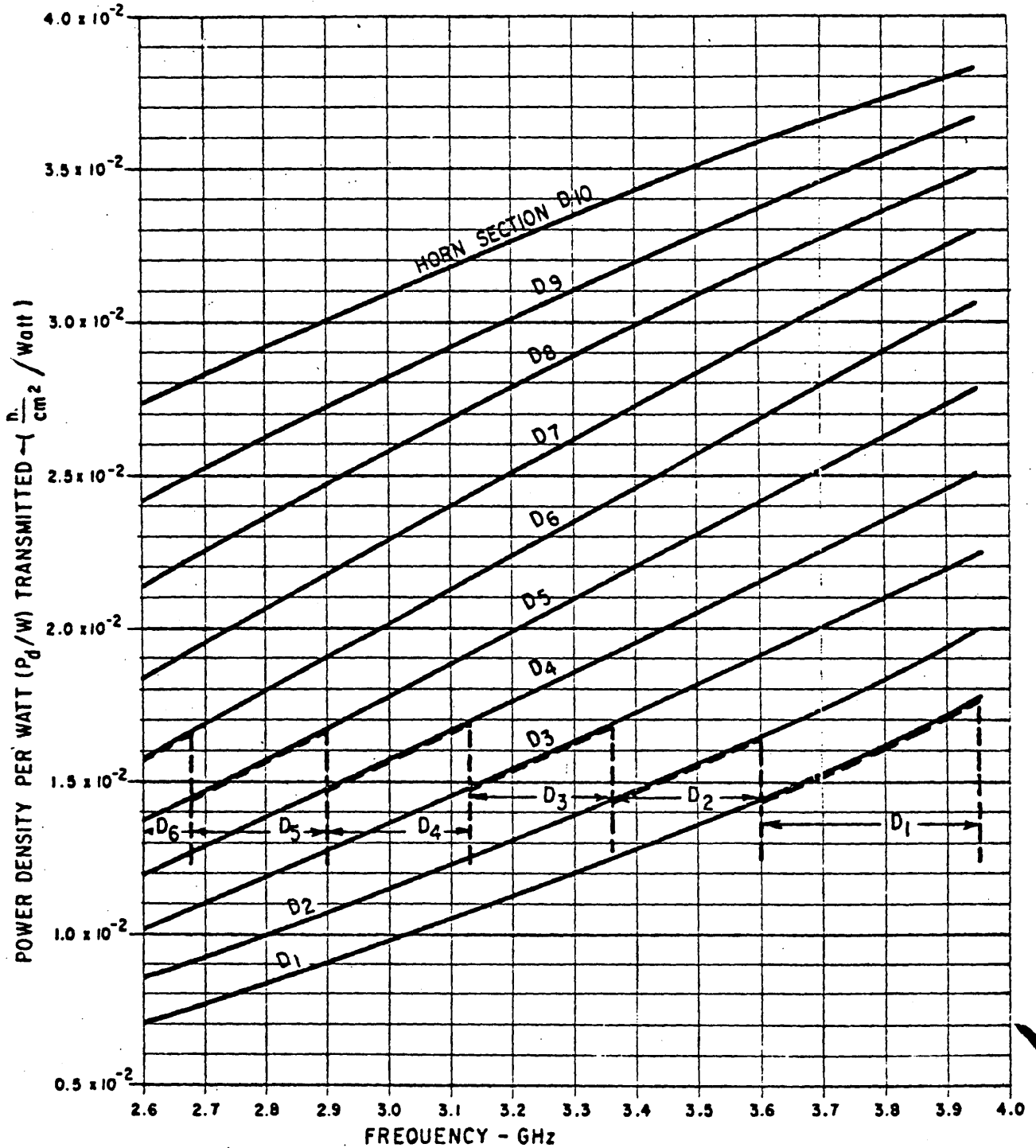

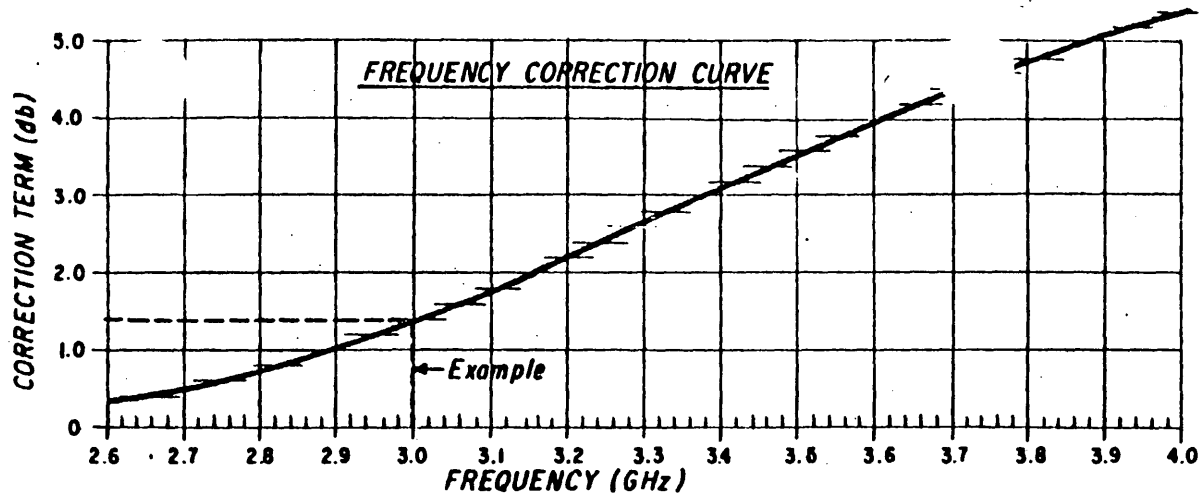

Fig. 11 POWER DENSITY PER WATT TRANSMITTED FOR EACH HORN SECTION (FOR TRANSMISSION LENGTH = 23.0')



ARROWS SHOW FREQUENCY RANGES

EFFECTIVE AREA-289 CM<sup>2</sup>



**TO MEASURE POWER DENSITY:**

ADD CORRECTION TERM TO METER READING

Example: AT 3.0 GHz, CORRECTION TERM = 1.4 db  
 METER READING = 3.0 dbm  
 CORRECTED METER READING = 4.4 dbm  
 4.4 dbm  $\approx$  3.0 Milliwatts/cm<sup>2</sup>

**TO SET POWER DENSITY:**

SUBTRACT CORRECTION TERM FROM METER READING WHICH CORRESPONDS TO REQUIRED POWER DENSITY

ADJUST POWER TO OBTAIN THIS VALUE ON MONITOR CHANNEL NO 1 POWER METER.

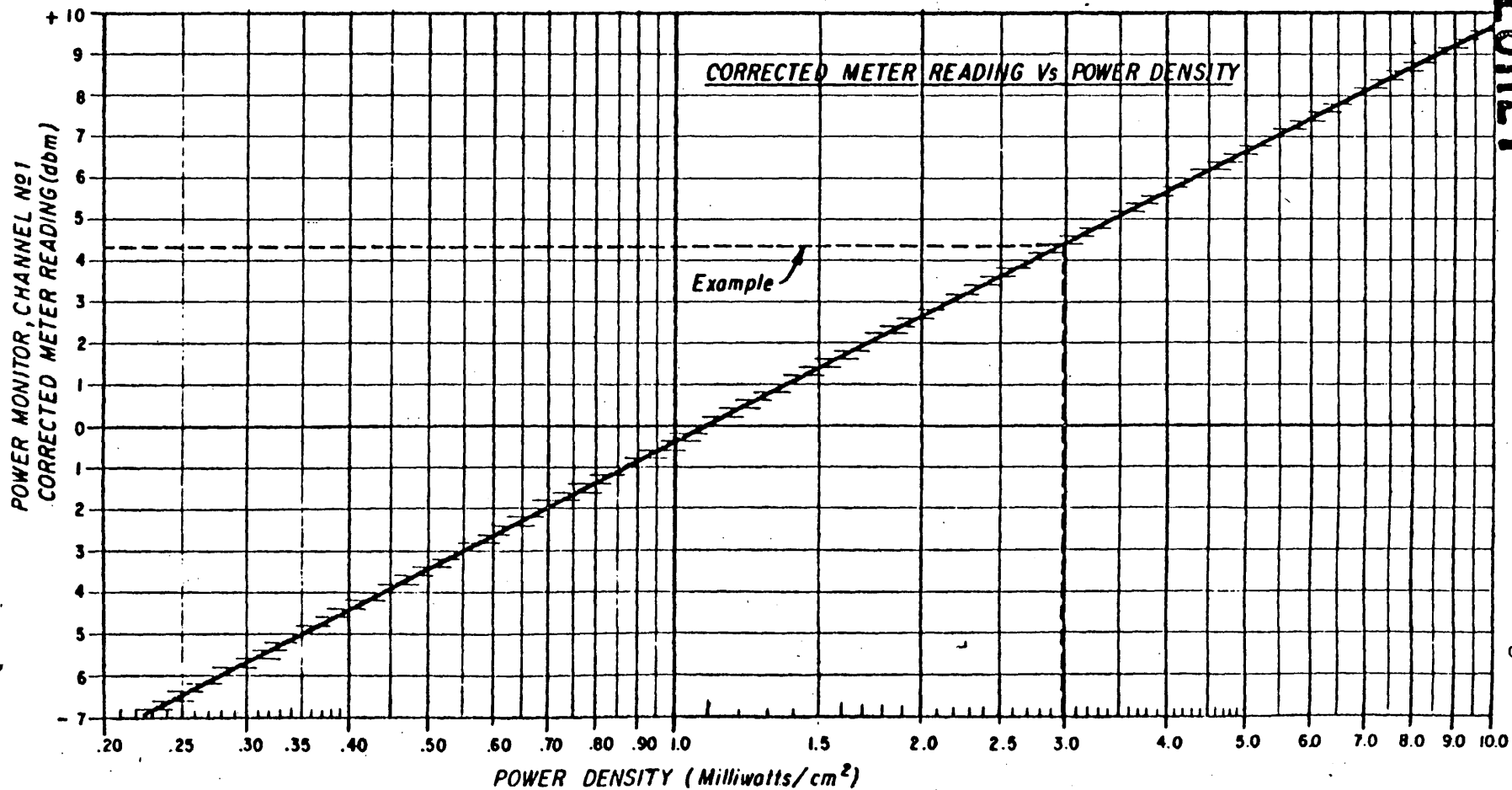

~~SECRET~~

SECRET

~~SECRET~~

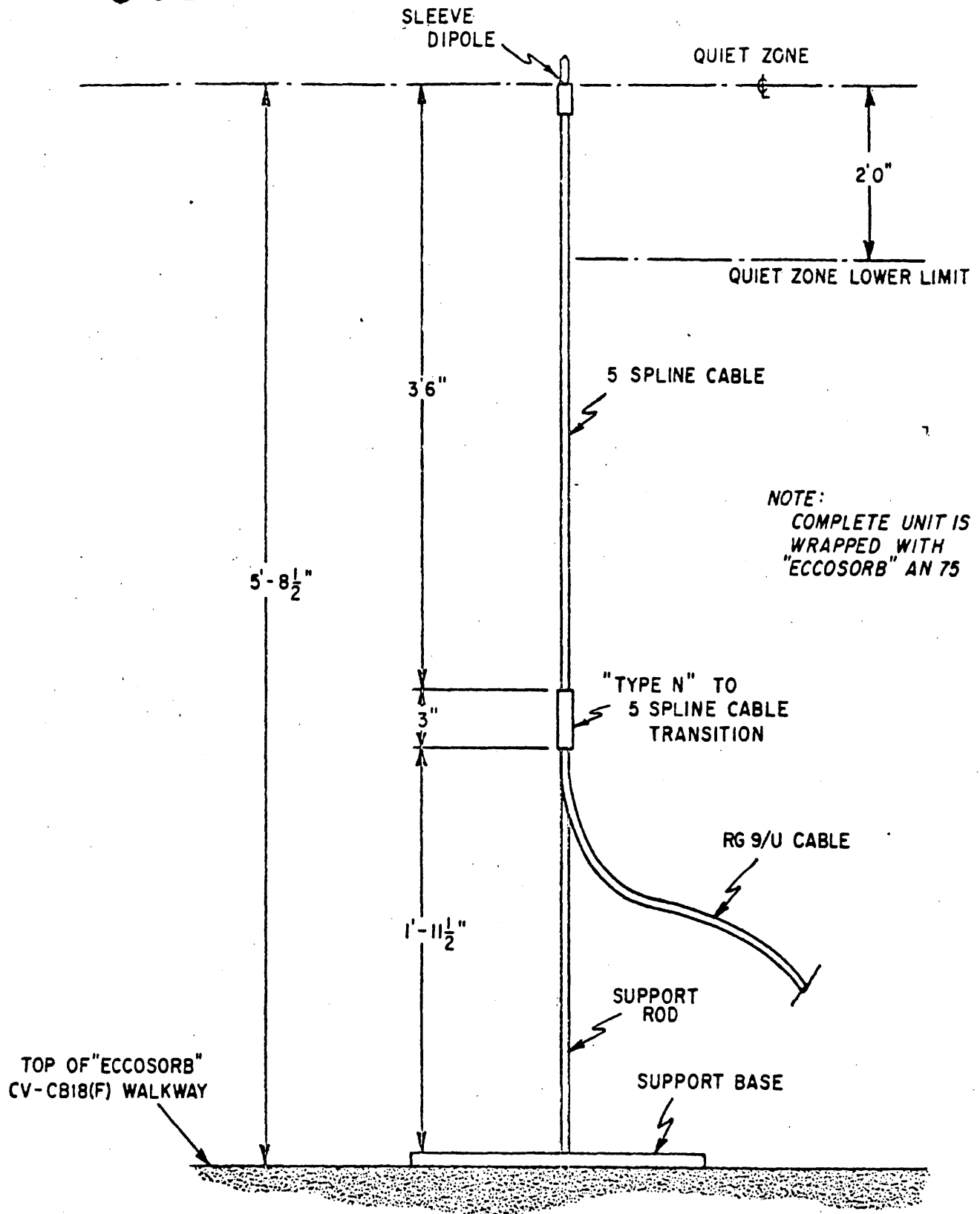

Fig. 13 FIXED DIPOLE MONITOR, STRAIGHT DIPOLE

~~SECRET~~

~~SECRET~~

— H PLANE  
- - - E PLANE  
[shaded] DESIGN FREQ. RANGE

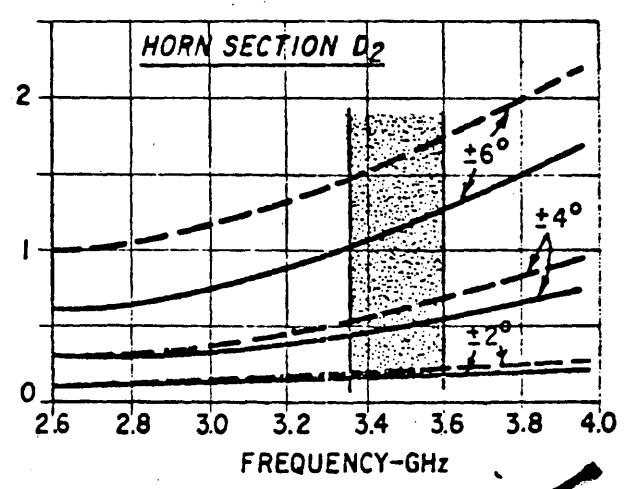
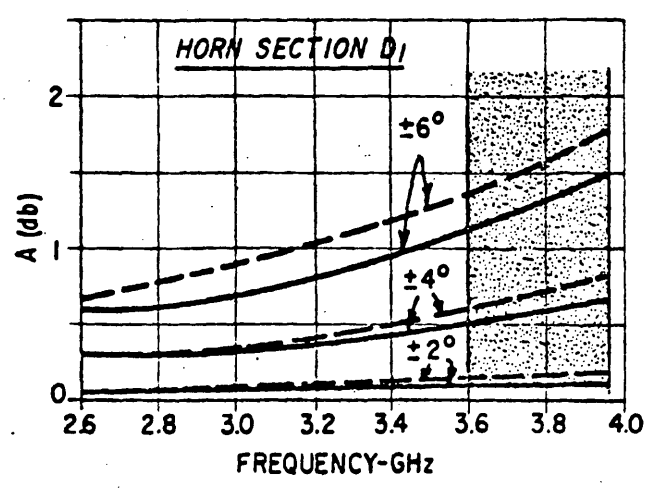
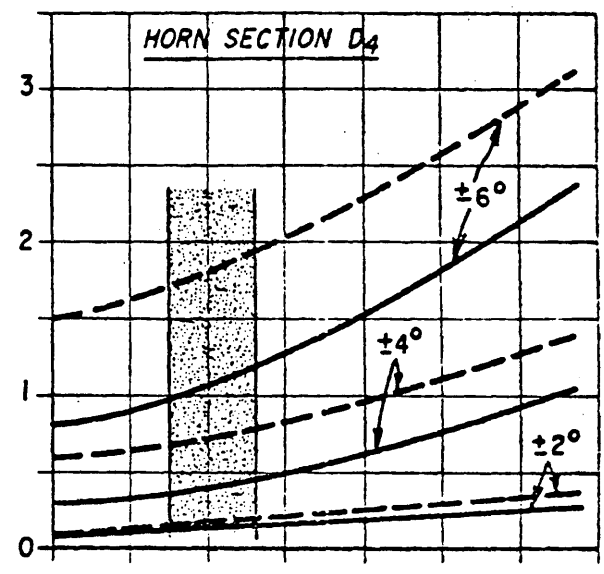
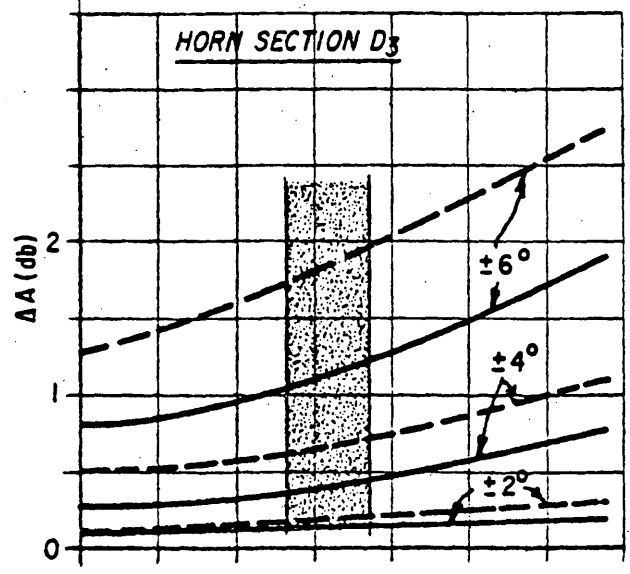
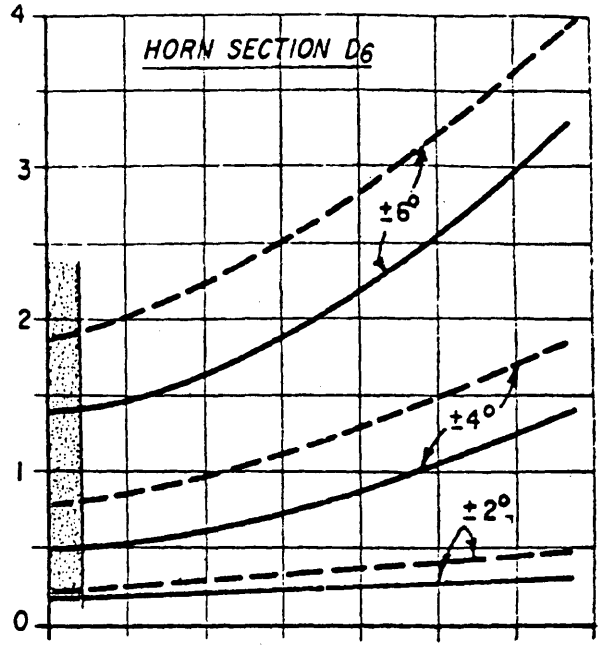
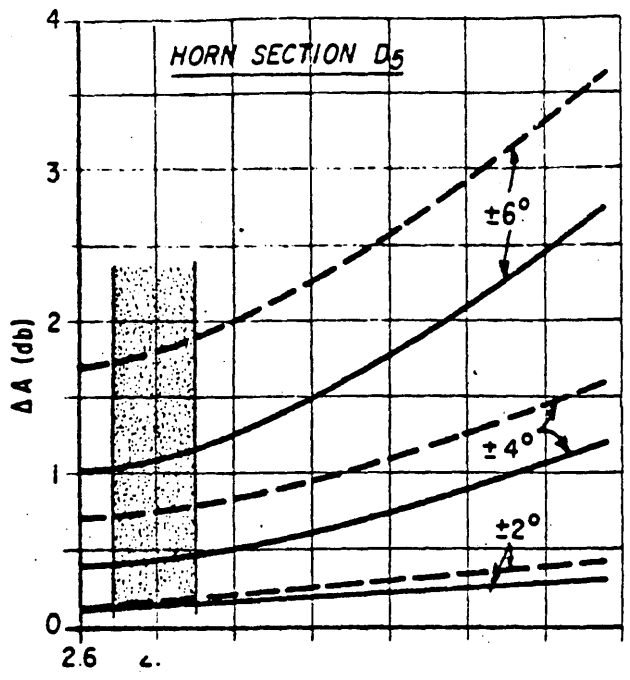
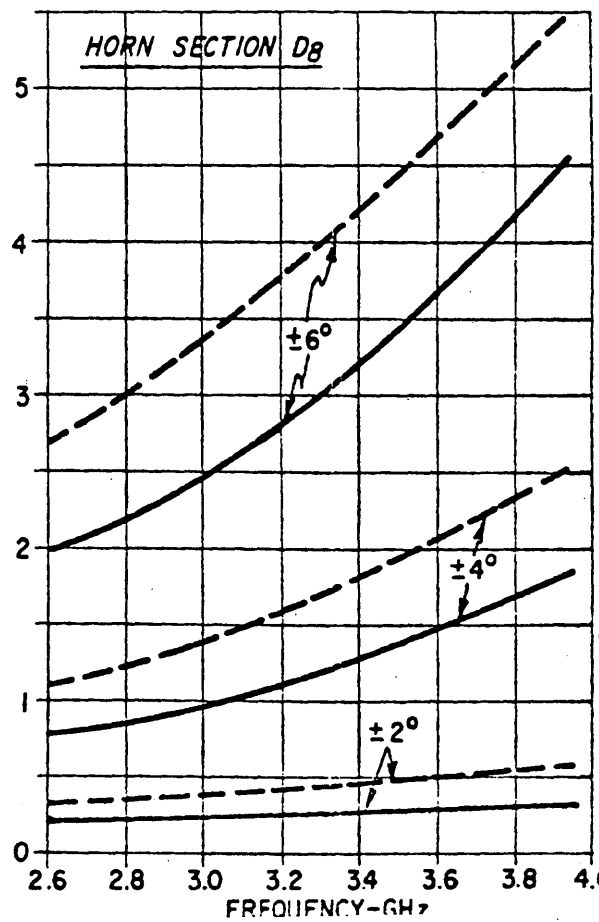
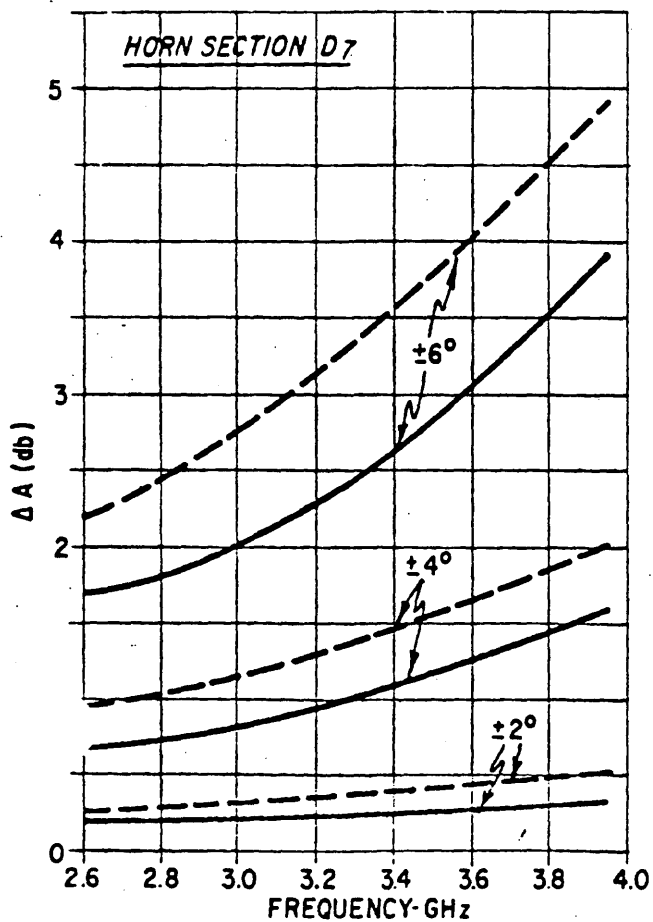
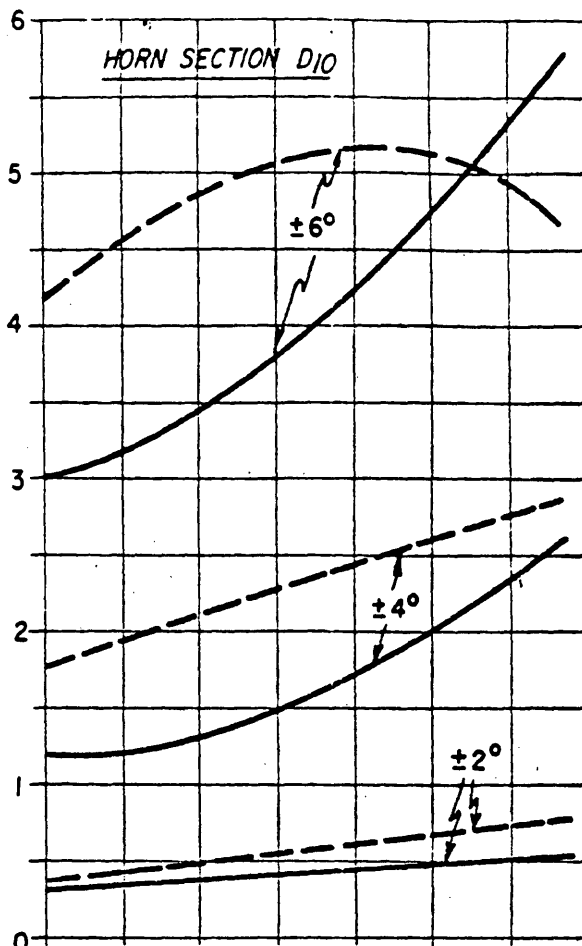
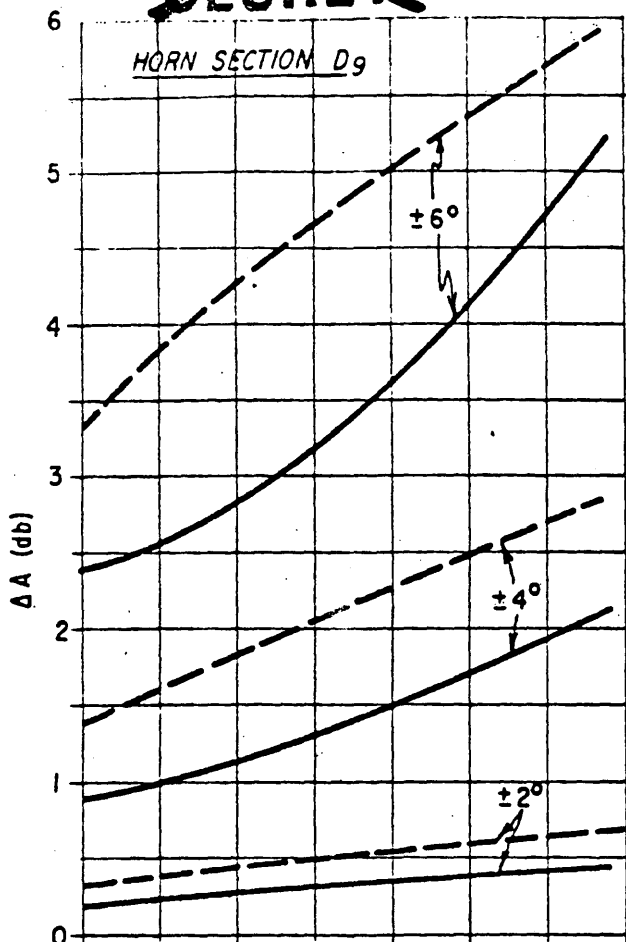

Fig. 14 CHANGE IN RELATIVE AMPLITUDE ( $\Delta A$ ) FOR VARIOUS FIXED ANGLE

~~SECRET~~

~~SECRET~~

— H PLANE  
- - - E PLANE



~~SECRET~~

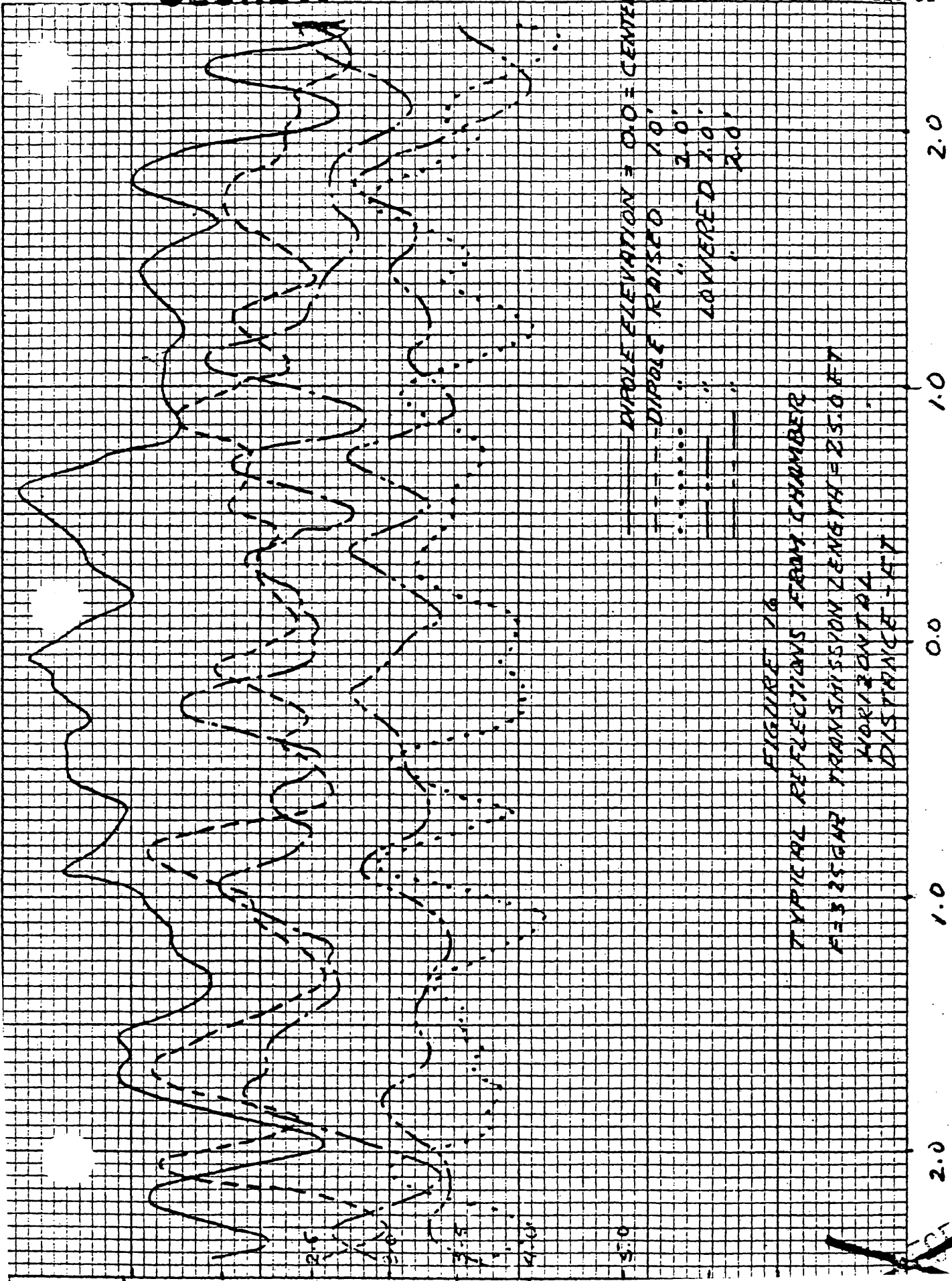

FIGURE 16  
 TYPICAL REFLECTIONS FROM CHAMBER  
 F = 325 MHz TRANSMISSION LENGTH = 25.0 FT  
 HORIZONTAL DISTANCE - FT

2.0 1.0 0.0 1.0 2.0

DIPOLE ELEVATION = 0.0 = CENTER  
 DIPOLE RAISED 1.0'  
 DIPOLE RAISED 2.0'  
 DIPOLE LOWERED 1.0'  
 DIPOLE LOWERED 2.0'

5

2.5

3.0

3.5

4.0

4.5

5.0

5.0

SECRET

AL CE		TRANSMISSION LENGTH = 23.0'			
		RELATIVE POWER LEVEL (db) IN HORIZONTAL DISTANCES OF:			MAX. RIPPLE
		+2.0'	+1.5'	+1.0'	
2.0'	MAX	-1.0	-1.0	-1.0	+1.0
	MIN	-3.5	-3.25	-3.75	-1.0
1.5'	MAX	2.0	2.0	2.0	+1.0
	MIN	1.5	1.5	1.75	-0.75
1.0'	MAX	0.5	0.5	0.5	+0.5
	MIN	0.5	0.5	0.5	-0.5
0.0'	MAX	0.5	0.5	0.5	+0.5
	MIN	0.5	0.5	0.5	-0.5
1.0'	MAX	0.5	0.5	0.5	+0.5
	MIN	0.5	0.5	0.5	-0.5
1.5'	MAX	0.0	0.0	0.0	+0.5
	MIN	1.25	1.25	1.25	-0.5
2.0'	MAX	-0.25	-0.25	-0.25	+0.5
	MIN	-1.25	-1.25	-1.25	-0.0

		TRANSMISSION LENGTH = 23.5'			
		RELATIVE POWER LEVEL (db) IN HORIZONTAL DISTANCES OF:			MAX. RIPPLE
		+2.0'	+1.5'	+1.0'	
2.0'	MAX	1.5	1.25	1.5	+0.75
	MIN	1.0	1.25	1.25	-0.75
1.5'	MAX	1.25	1.5	1.25	+0.5
	MIN	2.0	2.0	1.75	-0.5
1.0'	MAX	0.75	1.0	0.75	+0.5
	MIN	1.0	1.25	1.25	-0.5
0.0'	MAX	0.75	0.75	0.75	+0.5
	MIN	1.5	1.25	1.25	-0.5
1.0'	MAX	0.0	0.0	0.0	+0.5
	MIN	1.0	1.0	1.0	-0.5
1.5'	MAX	0.0	0.0	0.0	+0.5
	MIN	1.0	1.25	1.0	-0.75
2.0'	MAX	0.0	0.0	0.0	+0.5
	MIN	1.75	1.5	1.25	-0.5

		TRANSMISSION LENGTH = 24.0'			
		RELATIVE POWER LEVEL (db) IN HORIZONTAL DISTANCES OF:			MAX. RIPPLE
		+2.0'	+1.5'	+1.0'	
2.0'	MAX	1.25	1.25	1.50	+1.0
	MIN	3.0	1.5	1.0	-0.75
1.5'	MAX	1.5	1.5	1.5	+0.5
	MIN	1.0	2.0	1.5	-0.5
1.0'	MAX	1.0	1.0	1.0	+0.75
	MIN	1.5	1.5	1.5	-0.5
0.0'	MAX	0.5	0.75	0.75	+0.5
	MIN	1.5	1.5	1.5	-0.5
1.0'	MAX	0.75	0.75	0.75	+0.5
	MIN	1.5	1.5	1.5	-0.75
1.5'	MAX	0.25	0.25	0.25	+0.5
	MIN	1.75	1.5	1.25	-0.5
2.0'	MAX	0.25	-0.25	0.25	+0.5
	MIN	1.75	1.25	1.5	-0.5

		TRANSMISSION LENGTH = 25.0'			
		RELATIVE POWER LEVEL (db) IN HORIZONTAL DISTANCES OF:			MAX. RIPPLE
		+2.0'	+1.5'	+1.0'	
2.0'	MAX	1.75	1.75	1.75	+1.0
	MIN	3.5	3.5	3.5	-1.0
1.5'	MAX	2.0	2.0	2.0	+0.5
	MIN	3.25	3.25	3.25	-0.5
1.0'	MAX	1.0	1.0	1.0	+0.5
	MIN	3.25	1.75	3.5	-1.25
0.0'	MAX	-0.25	0.25	0.0	+0.75
	MIN	1.75	1.75	1.75	-0.75
1.0'	MAX	0.0	0.0	0.0	+0.5
	MIN	1.5	1.25	1.25	-0.75
1.5'	MAX	0.75	-0.75	-0.75	+0.75
	MIN	2.0	2.0	2.0	-0.50
2.0'	MAX	0.0	0.0	0.0	+0.5
	MIN	1.75	1.75	1.75	-1.0







CAL NCE		TRANSMISSION LENGTH = 26.0'			
		RELATIVE POWER LEVEL (db) IN HORIZONTAL DISTANCES OF:			MAX. RIPPLE
		+2.0'	+1.5'	+1.0'	
2.0'	MAX	-2.25	-2.25	2.25	+0.75
	MIN	-4.25	-4.25	1.0	-1.00
1.5'	MAX	2.25	2.25	2.5	+0.5
	MIN	4.0	1.75	1.75	-1.5
1.0'	MAX	1.5	1.75	1.5	+0.75
	MIN	2.75	1.5	2.75	-0.25
0.0'	MAX	0.75	0.75	1.0	+0.5
	MIN	2.0	2.0	1.5	-0.75
1.0'	MAX	0.0	0.0	0.0	+1.0
	MIN	1.75	1.75	1.75	-0.5
1.5'	MAX	0.5	0.5	0.5	+1.0
	MIN	2.5	2.5	2.5	-0.75
2.0'	MAX	-0.25	-0.25	-0.25	+0.5
	MIN	-1.75	-1.75	-1.75	-0.5

		TRANSMISSION LENGTH = 26.5'			
		RELATIVE POWER LEVEL (db) IN HORIZONTAL DISTANCES OF:			MAX. RIPPLE
		+2.0'	+1.5'	+1.0'	
2.0'	MAX	-2.5	-2.5	-2.5	+1.0
	MIN	-4.75	-4.75	-4.5	-1.0
1.5'	MAX	2.0	2.0	2.0	+0.75
	MIN	4.0	3.5	3.25	-1.00
1.0'	MAX	2.0	2.0	2.0	+0.5
	MIN	3.5	3.5	3.5	-0.75
0.0'	MAX	-0.5	-0.5	-0.5	+1.0
	MIN	2.25	2.25	2.25	-0.75
1.0'	MAX	-0.5	-0.5	-0.5	+0.5
	MIN	2.25	2.25	1.75	-0.5
1.5'	MAX	-0.75	-0.75	-0.75	+0.75
	MIN	2.25	2.25	2.25	-0.75
2.0'	MAX	-0.5	-0.5	-0.5	+0.75
	MIN	-2.0	-2.0	-2.0	-0.75

		TRANSMISSION LENGTH = 27.0'			
		RELATIVE POWER LEVEL (db) IN HORIZONTAL DISTANCES OF:			MAX. RIPPLE
		+2.0'	+1.5'	+1.0'	
2.0'	MAX	-3.0	-3.0	-3.0	+0.75
	MIN	-4.5	-4.5	-4.5	-0.75
1.5'	MAX	1.75	1.75	1.75	+0.75
	MIN	0.0	1.0	1.0	-0.50
1.0'	MAX	2.0	2.0	2.0	+0.75
	MIN	4.0	1.75	1.75	-0.75
0.0'	MAX	1.0	1.0	1.0	+0.75
	MIN	0.0	2.75	2.75	-0.75
1.0'	MAX	0.75	0.75	0.75	+0.75
	MIN	2.25	2.25	2.25	-0.75
1.5'	MAX	0.75	0.75	0.75	+0.75
	MIN	2.5	2.5	2.5	-1.0
2.0'	MAX	-0.75	-0.75	-0.75	+0.0
	MIN	-2.25	-2.25	-2.25	-0.0

Figure 17  
CHAMBER EVALUATION  
FREQUENCY: 2.6 GHz  
TRANSMITTING HORN SECTION: D6  
RECEIVING ANTENNA: Absorber backed dipole  
DATE: 8-22-66

NOTES:

-  = +0.5 to -1.5 = +1.0db
-  = +0.5 to -2.0 = +1.25db
-  = +0.5 to -2.5 = +1.5db
-  = +0.5 to -3.0 = +1.75db
-  = +0.5 to -3.5 = +2.0db
-  = +0.5 to -4.0 = +2.25db
-  = +0.5 to -5.0 = +2.75db

~~SECRET~~ SECRET

~~SECRET~~

CAL RICE		TRANSMISSION LENGTH = 23.0'			
		RELATIVE POWER LEVEL (db) IN HORIZONTAL DISTANCES OF:			MAX. RIPPLE
		+2.0'	+1.5'	+1.0'	
2.0'	MAX	-1.25	-1.25	-0.75	+0.25
	MIN	-3.5	-2.75	-2.0	-0.25
1.5'	MAX	-1.5	-1.5	-0.0	+0.5
	MIN	-3.5	-2.75	-1.5	-0.5
1.0'	MAX	-1.5	-1.5	-0.0	+0.5
	MIN	-3.5	-2.75	-1.0	-0.5
1.0'	MAX	-1.5	-1.5	-0.0	+0.5
	MIN	-3.5	-2.75	-1.0	-0.5
1.0'	MAX	-1.5	-1.5	-0.5	+0.5
	MIN	-3.5	-2.75	-1.5	-0.5
1.5'	MAX	-1.5	-1.5	-0.5	+0.5
	MIN	-3.5	-2.75	-1.5	-0.25
2.0'	MAX	-1.5	-1.5	-0.5	+0.5
	MIN	-3.5	-2.75	-2.0	-0.5

CAL RICE		TRANSMISSION LENGTH = 23.5'			
		RELATIVE POWER LEVEL (db) IN HORIZONTAL DISTANCES OF:			MAX. RIPPLE
		+2.0'	+1.5'	+1.0'	
2.0'	MAX	-1.25	-1.25	-0.75	+0.75
	MIN	-3.5	-2.75	-2.0	-0.5
1.5'	MAX	-1.5	-1.5	+0.75	+0.5
	MIN	-3.5	-2.75	-1.75	-0.5
1.0'	MAX	-1.5	-1.5	-0.0	+0.5
	MIN	-3.5	-2.75	-1.5	-0.5
1.0'	MAX	-1.5	-1.5	-0.0	+0.5
	MIN	-3.5	-2.75	-1.75	-0.25
1.0'	MAX	-1.5	-1.5	-1.0	+0.5
	MIN	-3.5	-2.75	-2.0	-0.5
1.5'	MAX	-1.5	-1.5	-0.5	+0.25
	MIN	-3.5	-2.75	-1.75	-0.25
2.0'	MAX	-1.5	-1.5	-0.5	+0.5
	MIN	-3.5	-2.5	-2.0	-0.5

CAL RICE		TRANSMISSION LENGTH = 24.0'			
		RELATIVE POWER LEVEL (db) IN HORIZONTAL DISTANCES OF:			MAX. RIPPLE
		+2.0'	+1.5'	+1.0'	
2.0'	MAX	-1.25	-1.25	-1.25	+0.5
	MIN	-3.5	-3.0	-2.25	-0.5
1.5'	MAX	-1.5	-1.5	+1.0	+0.5
	MIN	-3.5	-2.0	-2.0	-0.5
1.0'	MAX	-1.5	-1.5	-0.5	+0.25
	MIN	-3.5	-1.5	-1.0	-0.25
1.0'	MAX	-1.5	-1.5	-0.25	+0.5
	MIN	-3.5	-1.5	-1.25	-0.5
1.0'	MAX	-1.5	-1.5	-0.5	+0.5
	MIN	-3.5	-2.0	-1.5	-0.5
1.5'	MAX	-1.5	-1.5	-1.0	+0.75
	MIN	-3.5	-2.0	-2.0	-0.5
2.0'	MAX	-1.5	-1.5	-1.5	+0.5
	MIN	-3.5	-3.0	-2.75	-0.75

CAL RICE		TRANSMISSION LENGTH = 25.0'			
		RELATIVE POWER LEVEL (db) IN HORIZONTAL DISTANCES OF:			MAX. RIPPLE
		+2.0'	+1.5'	+1.0'	
2.0'	MAX	-1.5	-1.5	-1.5	+0.5
	MIN	-3.0	-2.5	-2.5	-0.5
1.5'	MAX	-1.0	-1.0	-1.0	+0.75
	MIN	-3.0	-3.0	-2.5	-0.75
1.0'	MAX	-0.5	-0.5	-0.5	+0.5
	MIN	-2.25	-2.25	-1.5	-0.5
1.0'	MAX	-0.75	-0.75	-0.75	+0.75
	MIN	-2.25	-2.25	-2.0	-0.75
1.0'	MAX	-1.5	-1.5	-1.5	+0.5
	MIN	-3.0	-2.5	-2.5	-0.5
1.5'	MAX	-1.0	-1.0	-1.0	+0.25
	MIN	-3.0	-2.25	-2.0	-0.5
2.0'	MAX	-1.75	-1.75	-1.75	+0.5
	MIN	-3.5	-2.75	-3.0	-0.5

CAL RICE		TRANSMISSION LENGTH = 26.0'			
		RELATIVE POWER LEVEL (db) IN HORIZONTAL DISTANCES OF:			MAX. RIPPLE
		+2.0'	+1.5'	+1.0'	
2.0'	MAX	-1.5	-1.5	-1.5	+0.75
	MIN	-3.5	-3.25	-3.0	-0.75
1.5'	MAX	-1.5	-1.5	-1.5	+0.5
	MIN	-3.5	-2.5	-2.5	-0.5
1.0'	MAX	-1.0	-1.0	-1.0	+0.75
	MIN	-2.5	-2.25	-2.0	-0.75
1.0'	MAX	-1.0	-1.0	-1.0	+0.5
	MIN	-3.0	-2.25	-2.0	-0.75
1.0'	MAX	-1.5	-1.5	-1.5	+0.5
	MIN	-3.5	-2.75	-2.75	-0.75
1.5'	MAX	-1.5	-1.5	-1.5	+0.75
	MIN	-3.5	-3.0	-2.5	-0.75
2.0'	MAX	-1.5	-1.5	-1.5	+0.5
	MIN	-3.5	-3.5	-3.5	-0.5

CAL RICE		TRANSMISSION LENGTH = 26.5'			
		RELATIVE POWER LEVEL (db) IN HORIZONTAL DISTANCES OF:			MAX. RIPPLE
		+2.0'	+1.5'	+1.0'	
2.0'	MAX	-2.5	-2.5	-2.5	+0.75
	MIN	-3.5	-3.25	-3.25	-0.75
1.5'	MAX	-1.75	-1.75	-1.75	+0.25
	MIN	-3.5	-2.75	-2.50	-0.25
1.0'	MAX	-1.25	-1.25	-1.25	+0.5
	MIN	-3.5	-2.5	-2.0	-0.5
1.0'	MAX	-1.25	-1.25	-1.25	+0.75
	MIN	-3.0	-2.75	-2.75	-0.75
1.0'	MAX	-1.75	-1.75	-1.75	+0.5
	MIN	-3.5	-3.0	-3.0	-0.25
1.5'	MAX	-1.5	-1.5	-1.5	+0.75
	MIN	-3.0	-3.0	-2.5	-0.75
2.0'	MAX	-1.5	-1.5	-1.5	+0.5
	MIN	-3.5	-3.5	-3.5	-0.5





CAL RICE		TRANSMISSION LENGTH = 27.0'			
		RELATIVE POWER LEVEL (db) IN HORIZONTAL DISTANCES OF:			MAX. RIPPLE
		+2.0'	+1.5'	+1.0'	
2.0'	MAX	-2.5	-2.5	-2.5	+0.25
	MIN	-3.5	-3.25	-3.25	-0.25
1.5'	MAX	-1.75	-1.75	-1.75	+0.5
	MIN	-3.5	-3.50	-2.75	-0.5
1.0'	MAX	-1.25	-1.25	-1.25	+0.75
	MIN	-2.75	-2.50	-2.50	-0.75
1.0'	MAX	-1.5	-1.5	-1.5	+0.5
	MIN	-3.5	-3.5	-2.5	-0.5
1.0'	MAX	-1.0	-1.0	-1.0	+0.5
	MIN	-3.5	-3.25	-3.25	-0.5
1.5'	MAX	-1.5	-1.5	-1.5	+1.0
	MIN	-3.5	-3.0	-2.75	-1.0
2.0'	MAX	-2.25	-2.25	-2.25	+0.5
	MIN	-3.5	-3.5	-3.5	-0.5

Figure 18.  
CHAMBER EVALUATION

FREQUENCY: 2.8 GHz  
 TRANSMITTING HORN SECTION: b5  
 RECEIVING ANTENNA: Absorber backed dipole

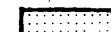
DATE: 8/23/66

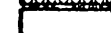
NOTES:

-  = 0.0 - 2.0 db = ± 1.0 db
-  = 0.0 - 2.5 db = ± 1.25 db
-  = 0.0 - 3.0 db = ± 1.5 db
-  = 0.0 - 3.5 db = ± 1.75 db
-  = 0.0 - 4.0 db = ± 2.0 db

~~SECRET~~

~~SECRET~~



RADIATION DISTANCE		TRANSMISSION LENGTH = 23.0'			
		RELATIVE POWER LEVEL (db) IN HORIZONTAL DISTANCES OF:			MAX. RIPPLE
		+2.0'	+1.5'	+1.0'	
2.0'	MAX	-1.0	-1.0	-0.8	+0.5
	MIN	-2.25	-2.25	-2.25	-0.5
1.5'	MAX	-1.0	-1.0	-1.0	+0.5
	MIN	-2.25	-2.25	-2.25	-0.5
1.0'	MAX	-1.0	-1.0	-1.0	+0.5
	MIN	-2.25	-2.0	-1.75	-0.25
R 0.0	MAX	-0.25	-0.25	-0.25	+0.5
	MIN	-2.00	-1.5	-1.0	-0.5
1.0'	MAX	-0.25	-0.25	-0.25	+0.5
	MIN	-2.0	-1.25	-0.75	-0.5
1.5'	MAX	-0.25	-0.25	-0.25	+0.5
	MIN	-2.25	-1.50	-1.0	-0.5
2.0'	MAX	-1.75	-1.75	-1.75	+0.5
	MIN	-3.0	-2.0	-1.50	-0.5

RADIATION DISTANCE		TRANSMISSION LENGTH = 23.5'			
		RELATIVE POWER LEVEL (db) IN HORIZONTAL DISTANCES OF:			MAX. RIPPLE
		+2.0'	+1.5'	+1.0'	
2.0'	MAX	-1.75	-1.75	-1.75	+0.5
	MIN	-4.0	-2.75	-2.0	-0.5
1.5'	MAX	-1.75	-1.75	-1.75	+0.5
	MIN	-2.75	-2.25	-2.0	-0.5
1.0'	MAX	-1.5	-1.5	-1.5	+0.25
	MIN	-2.75	-2.25	-2.0	-0.25
R 0.0	MAX	-0.5	-0.5	-0.5	+0.5
	MIN	-2.0	-1.75	-1.5	-0.5
1.0'	MAX	-0.5	-0.5	-0.5	+0.25
	MIN	-1.75	-1.50	-1.0	-0.25
1.5'	MAX	-0.25	-0.25	-0.25	+0.75
	MIN	-2.25	-1.50	-1.0	-0.5
2.0'	MAX	-1.75	-1.75	-1.75	+0.5
	MIN	-3.5	-2.75	-2.50	-0.5

RADIATION DISTANCE		TRANSMISSION LENGTH = 24.0'			
		RELATIVE POWER LEVEL (db) IN HORIZONTAL DISTANCES OF:			MAX. RIPPLE
		+2.0'	+1.5'	+1.0'	
2.0'	MAX	-1.75	-1.75	-1.75	+0.5
	MIN	-4.25	-2.75	-2.25	-0.5
1.5'	MAX	-0.75	-0.75	-0.75	+0.5
	MIN	-2.5	-2.25	-2.0	-0.25
1.0'	MAX	-1.5	-1.5	-1.5	+0.25
	MIN	-2.75	-2.25	-2.0	-0.25
R 0.0	MAX	-0.5	-0.5	-0.5	+0.5
	MIN	-2.25	-1.75	-1.75	-0.75
1.0'	MAX	-0.75	-0.75	-0.75	+0.5
	MIN	-2.0	-1.75	-1.5	-0.5
1.5'	MAX	-0.75	-0.75	-0.75	+0.25
	MIN	-2.25	-1.75	-1.5	-0.25
2.0'	MAX	-1.50	-1.50	-1.50	+0.5
	MIN	-3.25	-2.25	-2.25	-0.5

RADIATION DISTANCE		TRANSMISSION LENGTH = 25.0'			
		RELATIVE POWER LEVEL (db) IN HORIZONTAL DISTANCES OF:			MAX. RIPPLE
		+2.0'	+1.5'	+1.0'	
2.0'	MAX	-1.75	-1.75	-1.75	+0.5
	MIN	-4.25	-2.75	-2.25	-0.5
1.5'	MAX	-0.75	-0.75	-0.75	+0.5
	MIN	-2.50	-2.25	-2.0	-0.25
1.0'	MAX	-1.5	-1.5	-1.5	+0.5
	MIN	-2.75	-2.25	-2.0	-0.5
R 0.0	MAX	-1.0	-1.0	-1.0	+0.5
	MIN	-2.0	-1.5	-1.0	-0.5
1.0'	MAX	-1.0	-1.0	-1.0	+0.5
	MIN	-2.5	-2.25	-2.25	-0.5
1.5'	MAX	-0.5	-0.5	-0.5	+0.75
	MIN	-2.25	-1.75	-1.5	-0.50
2.0'	MAX	-1.75	-1.75	-1.75	+0.5
	MIN	-3.25	-2.25	-2.25	-0.5

RADIATION DISTANCE		TRANSMISSION LENGTH = 26.0'			
		RELATIVE POWER LEVEL (db) IN HORIZONTAL DISTANCES OF:			MAX. RIPPLE
		+2.0'	+1.5'	+1.0'	
2.0'	MAX	-2.25	-2.25	-2.25	+0.5
	MIN	-4.25	-3.25	-3.0	-0.5
1.5'	MAX	-2.5	-2.5	-2.5	+0.5
	MIN	-4.0	-3.25	-2.75	-0.5
1.0'	MAX	-1.5	-1.5	-1.5	+0.25
	MIN	-2.75	-2.25	-2.0	-0.5
R 0.0	MAX	-0.5	-0.5	-0.5	+0.5
	MIN	-2.25	-1.75	-1.5	-0.5
1.0'	MAX	-0.75	-0.75	-0.75	+0.75
	MIN	-2.75	-2.25	-2.0	-0.5
1.5'	MAX	-1.75	-1.75	-1.75	+0.25
	MIN	-2.75	-2.25	-2.0	-0.25
2.0'	MAX	-1.75	-1.75	-1.75	+0.25
	MIN	-3.50	-2.75	-2.75	-0.25

RADIATION DISTANCE		TRANSMISSION LENGTH = 26.5'			
		RELATIVE POWER LEVEL (db) IN HORIZONTAL DISTANCES OF:			MAX. RIPPLE
		+2.0'	+1.5'	+1.0'	
2.0'	MAX	-2.25	-2.25	-2.25	+0.5
	MIN	-4.25	-3.25	-2.75	-0.5
1.5'	MAX	-2.5	-2.5	-2.5	+0.75
	MIN	-4.25	-4.25	-4.25	-1.0
1.0'	MAX	-1.5	-1.5	-1.5	+0.5
	MIN	-2.75	-2.25	-2.0	-0.5
R 0.0	MAX	-0.5	-0.5	-0.5	+0.25
	MIN	-2.25	-1.75	-1.5	-0.5
1.0'	MAX	-1.0	-1.0	-1.0	+0.25
	MIN	-2.75	-2.25	-2.0	-0.5
1.5'	MAX	-2.0	-2.0	-2.0	+0.5
	MIN	-3.25	-3.0	-3.0	-0.5
2.0'	MAX	-1.5	-1.5	-1.5	+0.5
	MIN	-3.5	-3.0	-2.75	-0.5

RADIATION DISTANCE		TRANSMISSION LENGTH = 27.0'			
		RELATIVE POWER LEVEL (db) IN HORIZONTAL DISTANCES OF:			MAX. RIPPLE
		+2.0'	+1.5'	+1.0'	
2.0'	MAX	-2.75	-2.75	-2.75	+1.0
	MIN	-5.0	-4.0	-4.0	-1.25
1.5'	MAX	-3.0	-3.0	-3.0	+0.25
	MIN	-4.5	-3.75	-3.5	-0.5
1.0'	MAX	-2.0	-2.0	-2.0	+0.5
	MIN	-3.25	-2.75	-2.5	-0.5
R 0.0	MAX	-1.0	-1.0	-1.0	+0.5
	MIN	-2.75	-2.25	-2.0	-0.5
1.0'	MAX	-1.5	-1.5	-1.5	+0.5
	MIN	-3.25	-2.75	-2.5	-0.5
1.5'	MAX	-2.5	-2.5	-2.5	+0.5
	MIN	-3.5	-3.0	-3.0	-0.5
2.0'	MAX	-1.75	-1.75	-1.75	+0.5
	MIN	-3.5	-3.0	-2.75	-0.5

Figure 19  
CHAMBER EVALUATION  
FREQUENCY: 3.0 GHz  
TRANSMITTING HORN SECTION: D4  
RECEIVING ANTENNA: Absorber backed dipole

DATE: 8/22/66

NOTES:

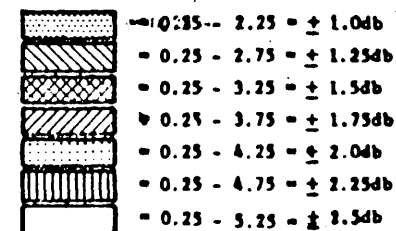

~~SECRET~~

~~SECRET~~

HORIZONTAL DISTANCE		TRANSMISSION LENGTH = 23.0'			
		RELATIVE POWER LEVEL (db) IN HORIZONTAL DISTANCES OF:			MAX. RIPPLE
		+2.0'	+1.5'	+1.0'	
2.0'	MAX	1.75	1.5	1.25	+0.75
	MIN	1.75	1.5	1.25	-0.75
1.5'	MAX	1.5	1.25	1.0	+0.5
	MIN	1.5	1.25	1.0	-0.5
1.0'	MAX	0.5	0.5	0.5	+0.5
	MIN	1.0	1.25	1.0	-0.5
OR 0.0'	MAX	0.5	0.5	0.5	+0.5
	MIN	1.0	1.25	1.0	-0.25
1.0'	MAX	0.5	0.75	0.75	+0.5
	MIN	1.75	1.75	2.0	-0.75
1.5'	MAX	1.75	1.75	1.75	+0.5
	MIN	1.0	1.0	1.75	-0.5
2.0'	MAX	1.0	1.0	1.0	+0.25
	MIN	1.0	0.75	0.5	-0.50

HORIZONTAL DISTANCE		TRANSMISSION LENGTH = 23.5'			
		RELATIVE POWER LEVEL (db) IN HORIZONTAL DISTANCES OF:			MAX. RIPPLE
		+2.0'	+1.5'	+1.0'	
2.0'	MAX	1.75	1.5	1.25	+0.5
	MIN	1.75	1.5	1.25	-0.5
1.5'	MAX	1.5	1.25	1.0	+0.5
	MIN	1.5	1.25	1.0	-0.5
1.0'	MAX	0.5	0.5	0.5	+0.5
	MIN	1.0	1.25	1.25	-0.5
OR 0.0'	MAX	0.5	1.0	1.0	+0.25
	MIN	1.25	1.25	1.75	-0.5
1.0'	MAX	1.25	1.25	1.25	+0.25
	MIN	1.0	0.5	1.25	-0.25
1.5'	MAX	1.5	1.5	1.5	+0.5
	MIN	1.0	1.0	1.0	-0.5
2.0'	MAX	1.5	1.5	1.5	+0.75
	MIN	1.0	1.0	1.0	-0.5

HORIZONTAL DISTANCE		TRANSMISSION LENGTH = 24.0'			
		RELATIVE POWER LEVEL (db) IN HORIZONTAL DISTANCES OF:			MAX. RIPPLE
		+2.0'	+1.5'	+1.0'	
2.0'	MAX	1.75	1.5	1.25	+0.75
	MIN	1.75	1.5	1.25	-0.75
1.5'	MAX	1.5	1.25	1.0	+0.75
	MIN	1.5	1.25	1.0	-1.00
1.0'	MAX	0.5	0.75	0.75	+0.5
	MIN	1.0	1.0	1.75	-0.5
OR 0.0'	MAX	0.5	0.5	0.5	+0.5
	MIN	1.0	1.25	1.5	-0.25
1.0'	MAX	1.25	1.25	1.25	+0.5
	MIN	1.0	0.5	1.25	-0.5
1.5'	MAX	1.5	1.5	1.5	+0.5
	MIN	1.0	1.0	1.0	-0.5
2.0'	MAX	1.0	1.0	1.25	+0.5
	MIN	1.0	1.0	1.0	-0.5

HORIZONTAL DISTANCE		TRANSMISSION LENGTH = 25.0'			
		RELATIVE POWER LEVEL (db) IN HORIZONTAL DISTANCES OF:			MAX. RIPPLE
		+2.0'	+1.5'	+1.0'	
2.0'	MAX	2.75	3.0	3.0	+0.75
	MIN	4.25	4.25	4.0	-0.75
1.5'	MAX	1.75	2.0	1.75	+0.75
	MIN	1.5	1.5	1.25	-0.75
1.0'	MAX	1.0	1.0	1.0	+0.5
	MIN	1.0	1.0	1.0	-0.5
OR 0.0'	MAX	1.0	1.0	1.0	+0.5
	MIN	2.5	2.0	1.5	-0.5
1.0'	MAX	1.75	1.75	1.75	+0.5
	MIN	1.0	1.75	1.75	-0.5
1.5'	MAX	1.5	1.5	1.5	+0.5
	MIN	1.75	1.75	1.75	-0.75
2.0'	MAX	2.5	2.5	2.5	+0.25
	MIN	3.5	3.5	3.5	-0.25

HORIZONTAL DISTANCE		TRANSMISSION LENGTH = 26.0'			
		RELATIVE POWER LEVEL (db) IN HORIZONTAL DISTANCES OF:			MAX. RIPPLE
		+2.0'	+1.5'	+1.0'	
2.0'	MAX	-2.75	-2.75	-2.75	+0.75
	MIN	-4.5	-4.5	-4.5	-0.75
1.5'	MAX	1.75	2.25	1.75	+0.5
	MIN	1.75	1.75	1.75	-0.5
1.0'	MAX	1.0	2.0	1.0	+0.5
	MIN	1.0	1.0	1.0	-0.5
OR 0.0'	MAX	1.5	1.75	1.5	+0.5
	MIN	1.75	1.75	1.75	-0.5
1.0'	MAX	1.5	1.5	1.5	+0.5
	MIN	1.5	1.5	1.5	-0.5
1.5'	MAX	1.75	1.75	1.75	+0.5
	MIN	1.0	1.5	1.5	-0.5
2.0'	MAX	-2.75	-2.75	-2.75	+0.5
	MIN	-5.0	-4.25	-4.25	-1.0

HORIZONTAL DISTANCE		TRANSMISSION LENGTH = 26.5'			
		RELATIVE POWER LEVEL (db) IN HORIZONTAL DISTANCES OF:			MAX. RIPPLE
		+2.0'	+1.5'	+1.0'	
2.0'	MAX	-2.5	-2.5	-2.5	+0.75
	MIN	-4.5	-4.0	-4.0	-0.5
1.5'	MAX	2.25	2.25	2.25	+0.75
	MIN	-3.5	-1.5	1.5	-0.50
1.0'	MAX	1.75	1.75	1.75	+0.5
	MIN	1.75	1.75	1.75	-0.5
OR 0.0'	MAX	1.5	1.5	1.5	+0.75
	MIN	1.5	1.5	1.5	-0.75
1.0'	MAX	1.5	1.5	1.5	+0.75
	MIN	1.5	1.5	1.5	-0.75
1.5'	MAX	1.75	1.75	1.75	+0.75
	MIN	-4.25	-1.75	-1.75	-0.75
2.0'	MAX	-2.75	-2.75	-2.75	+0.5
	MIN	-4.75	-4.75	-4.0	-0.5

HORIZONTAL DISTANCE		TRANSMISSION LENGTH = 27.0'			
		RELATIVE POWER LEVEL (db) IN HORIZONTAL DISTANCES OF:			MAX. RIPPLE
		+2.0'	+1.5'	+1.0'	
2.0'	MAX	-2.0	-2.0	-2.25	+0.5
	MIN	-3.25	-3.0	-3.0	-0.5
1.5'	MAX	-1.5	1.5	-1.5	+0.75
	MIN	-3.5	-1.0	-2.75	-0.75
1.0'	MAX	2.00	2.00	2.00	+0.75
	MIN	1.0	1.5	1.25	-0.75
OR 0.0'	MAX	1.00	1.00	1.25	+0.5
	MIN	1.25	1.0	1.0	-0.5
1.0'	MAX	1.75	1.75	1.75	+0.5
	MIN	1.0	1.75	1.75	-0.5
1.5'	MAX	1.75	1.75	1.75	+0.75
	MIN	-4.25	-1.0	-1.0	-0.50
2.0'	MAX	-2.75	-2.75	-2.75	+0.75
	MIN	-5.0	-4.5	-4.0	-0.75

Figure 20

CHAMBER EVALUATION

FREQUENCY: 3.25 GHz

TRANSMITTING HORN SECTION: D3

RECEIVING ANTENNA: Absorber backed dipole

DATE: 8/22/66 8/23/66

NOTES:

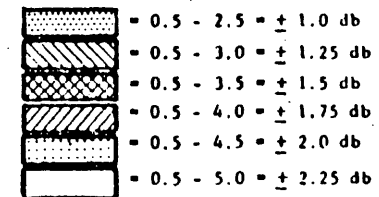

~~SECRET~~

~~SECRET~~

CAL NCE		TRANSMISSION LENGTH = 23.0'			
		RELATIVE POWER LEVEL (db) IN HORIZONTAL DISTANCES OF:			MAX. RIPPLE
		+2.0'	+1.5'	+1.0'	
2.0'	MAX				
	MIN				
1.5'	MAX	-1.75	-1.75	-1.75	
	MIN	-2.5	-2.5	-2.25	
1.0'	MAX	-1.0	-1.0	-1.0	
	MIN	-1.75	-2.0	-1.5	
R 0.0	MAX	-0.5	-0.5	-0.5	+125
	MIN	-1.25	-1.5	-1.0	-125
1.0'	MAX	-1.0	-1.0	-1.0	+125
	MIN	-1.75	-1.75	-1.25	-125
1.5'	MAX	-1.5	-1.5	-1.5	
	MIN	-2.25	-2.25	-1.75	
2.0'	MAX				
	MIN				

CAL NCE		TRANSMISSION LENGTH = 23.3'			
		RELATIVE POWER LEVEL (db) IN HORIZONTAL DISTANCES OF:			MAX. RIPPLE
		+2.0'	+1.5'	+1.0'	
2.0'	MAX	-2.25	-2.25	-2.25	
	MIN	-2.75	-3.5	-2.50	
1.5'	MAX	-1.75	-1.75	-1.75	
	MIN	-2.25	-2.25	-1.75	
1.0'	MAX	-1.0	-1.0	-1.0	
	MIN	-2.25	-1.75	-1.25	
R 0.0	MAX	-0.5	-0.5	-0.5	+0.125
	MIN	-1.75	-1.5	-1.0	-0.125
1.0'	MAX	-0.75	-0.75	-0.75	+125
	MIN	-2.25	-1.75	-1.25	-125
1.5'	MAX	-1.5	-1.5	-1.5	
	MIN	-2.0	-2.0	-1.75	
2.0'	MAX		-2.0	-2.0	
	MIN		-2.25	-2.25	

CAL NCE		TRANSMISSION LENGTH = 24.0'			
		RELATIVE POWER LEVEL (db) IN HORIZONTAL DISTANCES OF:			MAX. RIPPLE
		+2.0'	+1.5'	+1.0'	
2.0'	MAX				
	MIN				
1.5'	MAX	-1.75	-1.75	-1.75	
	MIN	-2.5	-2.5	-2.0	
1.0'	MAX	-1.0	-1.0	-1.0	
	MIN	-2.5	-2.0	-1.5	
R 0.0	MAX	-0.75	-0.75	-0.75	
	MIN	-2.0	-1.75	-1.25	
1.0'	MAX	-1.0	-1.0	-1.0	+0.125
	MIN	-2.5	-2.0	-1.5	-0.125
1.5'	MAX	-1.5	-1.5	-1.5	
	MIN	-2.25	-2.25	-2.0	
2.0'	MAX				
	MIN				

CAL NCE		TRANSMISSION LENGTH = 23.0'			
		RELATIVE POWER LEVEL (db) IN HORIZONTAL DISTANCES OF:			MAX. RIPPLE
		+2.0'	+1.5'	+1.0'	
2.0'	MAX				
	MIN				
1.5'	MAX	-2.25	-2.25	-2.25	
	MIN	-2.0	-2.25	-2.5	
1.0'	MAX	-1.0	-1.0	-2.0	
	MIN	-3.0	-2.5	-2.25	
R 0.0	MAX		-1.25	-1.25	
	MIN		-2.25	-1.75	
1.0'	MAX	-1.5	-1.5	-1.5	+0.125
	MIN	-2.25	-2.25	-2.0	-0.125
1.5'	MAX	-2.0	-2.0	-2.0	
	MIN	-3.0	-2.5	-2.25	
2.0'	MAX				
	MIN				

CAL NCE		TRANSMISSION LENGTH = 26.0'			
		RELATIVE POWER LEVEL (db) IN HORIZONTAL DISTANCES OF:			MAX. RIPPLE
		+2.0'	+1.5'	+1.0'	
2.0'	MAX				
	MIN				
1.5'	MAX			-2.25	
	MIN			-2.50	
1.0'	MAX			-2.25	
	MIN			-2.50	
R 0.0	MAX			-1.75	
	MIN			-2.00	
1.0'	MAX			-1.0	+125
	MIN			-2.25	-125
1.5'	MAX			-2.25	
	MIN			-2.5	
2.0'	MAX				+125
	MIN				-125

CAL NCE		TRANSMISSION LENGTH = 26.5'			
		RELATIVE POWER LEVEL (db) IN HORIZONTAL DISTANCES OF:			MAX. RIPPLE
		+2.0'	+1.5'	+1.0'	
2.0'	MAX				
	MIN				
1.5'	MAX				
	MIN				
1.0'	MAX				
	MIN				
R 0.0	MAX				
	MIN				
1.0'	MAX				
	MIN				
1.5'	MAX				
	MIN				
2.0'	MAX				
	MIN				

CAL NCE		TRANSMISSION LENGTH = 27.0'			
		RELATIVE POWER LEVEL (db) IN HORIZONTAL DISTANCES OF:			MAX. RIPPLE
		+2.0'	+1.5'	+1.0'	
2.0'	MAX				
	MIN				
1.5'	MAX				
	MIN				
1.0'	MAX				
	MIN				
R 0.0	MAX				
	MIN				
1.0'	MAX				
	MIN				
1.5'	MAX				
	MIN				
2.0'	MAX				
	MIN				

Figure 21  
CHAMBER EVALUATION





FREQUENCY: 3.25 GHz

TRANSMITTING HORN SECTION: D3

RECEIVING ANTENNA: Standard Gain  
Horn (Narda Model 44)

DATE: 8/23/66

NOTES:

-  = 0.5 - 2.5 = ± 1.0 db
-  = 0.5 - 3.00 = ± 1.25 db
-  = 0.5 - 3.5 = ± 1.5 db
-  = 0.5 - 4.0 = ± 1.75 db

SECRET

SECRET

RADIATION DISTANCE		TRANSMISSION LENGTH = 23.0'			
		RELATIVE POWER LEVEL (db) IN HORIZONTAL DISTANCES OF:			MAX. RIPPLE
		+2.0'	+1.5'	+1.0'	
2.0'	MAX	+0.5	-0.5	+1.5	+0.75
	MIN	-2.75	-2.25	-1.75	-0.5
1.5'	MAX	0.5	-0.5	+1.5	+0.75
	MIN	-2.5	-2.0	-1.75	-0.75
1.0'	MAX	+0.75	-0.75	+1.0	+0.75
	MIN	-2.5	-2.5	-1.75	-0.75
RADIATION DISTANCE 0.0'	MAX	+0.0	+0.5	+1.0	+0.5
	MIN	-2.25	-1.5	-1.5	-0.5
1.0'	MAX	+0.0	+0.0	+0.0	+0.5
	MIN	-1.75	-1.75	-1.75	-0.75
1.5'	MAX	+0.25	+0.25	+0.25	+0.5
	MIN	-2.25	-1.75	-1.5	-0.5
2.0'	MAX	+0.0	+0.0	+0.0	+0.5
	MIN	-1.7	-1.5	-1.5	-0.5

RADIATION DISTANCE		TRANSMISSION LENGTH = 23.5'			
		RELATIVE POWER LEVEL (db) IN HORIZONTAL DISTANCES OF:			MAX. RIPPLE
		+2.0'	+1.5'	+1.0'	
2.0'	MAX	+1.0	-1.0	-1.0	+1.0
	MIN	-3.0	-3.25	-3.25	-1.0
1.5'	MAX	0.75	-0.75	+1.0	+0.75
	MIN	-3.0	-1.0	-3.0	-0.75
1.0'	MAX	+1.5	-1.5	+1.5	+0.5
	MIN	-3.5	-3.0	-2.75	-0.75
RADIATION DISTANCE 0.0'	MAX	+0.0	+0.0	+0.0	+0.5
	MIN	-3.5	-1.5	-1.0	-0.5
1.0'	MAX	+0.0	+0.0	+0.0	+0.75
	MIN	-2.0	-1.25	-1.25	-0.75
1.5'	MAX	+0.0	+0.0	+0.0	+0.5
	MIN	-1.0	-1.0	-1.0	-0.5
2.0'	MAX	+0.25	+0.25	+0.25	+0.5
	MIN	-2.0	-1.75	-1.75	-0.5

RADIATION DISTANCE		TRANSMISSION LENGTH = 24.0'			
		RELATIVE POWER LEVEL (db) IN HORIZONTAL DISTANCES OF:			MAX. RIPPLE
		+2.0'	+1.5'	+1.0'	
2.0'	MAX	+1.0	-1.0	-1.0	+0.75
	MIN	-3.0	-2.75	-2.25	-0.75
1.5'	MAX	+1.0	-1.0	-1.0	+0.5
	MIN	-3.0	-2.75	-2.75	-0.5
1.0'	MAX	+1.0	-1.0	-1.0	+0.75
	MIN	-3.5	-2.75	-2.5	-0.5
RADIATION DISTANCE 0.0'	MAX	+1.25	-1.25	-1.25	+0.5
	MIN	-3.5	-2.5	-2.25	-0.5
1.0'	MAX	+0.25	+0.25	+0.25	+0.5
	MIN	-2.75	-1.5	-1.5	-0.5
1.5'	MAX	+0.25	+0.25	+0.25	+0.25
	MIN	-1.5	-1.5	-1.5	-0.5
2.0'	MAX	+0.5	+0.5	+0.5	+0.5
	MIN	-1.75	-1.75	-1.75	-0.5

RADIATION DISTANCE		TRANSMISSION LENGTH = 25.0'			
		RELATIVE POWER LEVEL (db) IN HORIZONTAL DISTANCES OF:			MAX. RIPPLE
		+2.0'	+1.5'	+1.0'	
2.0'	MAX	+1.0	-1.0	-1.0	+1.0
	MIN	-3.25	-2.75	-2.75	-0.75
1.5'	MAX	+1.5	-1.5	-1.5	-1.0
	MIN	-3.75	-3.25	-3.0	+1.0
1.0'	MAX	+1.25	-1.25	-1.25	+0.5
	MIN	-3.0	-2.75	-2.75	-0.5
RADIATION DISTANCE 0.0'	MAX	+1.50	-1.50	-1.50	+0.5
	MIN	-3.0	-2.5	-2.5	-0.5
1.0'	MAX	+0.75	+0.75	+0.75	+1.0
	MIN	-3.0	-2.5	-2.0	-1.0
1.5'	MAX	+0.75	+0.75	+0.75	+0.5
	MIN	-2.5	-1.75	-1.75	-0.5
2.0'	MAX	+0.5	+0.5	+0.5	+1.0
	MIN	-2.5	-1.75	-1.75	-1.0

RADIATION DISTANCE		TRANSMISSION LENGTH = 26.0'			
		RELATIVE POWER LEVEL (db) IN HORIZONTAL DISTANCES OF:			MAX. RIPPLE
		+2.0'	+1.5'	+1.0'	
2.0'	MAX	+1.75	-1.75	-1.75	+0.75
	MIN	-3.5	-3.5	-3.5	-0.75
1.5'	MAX	+1.75	-1.75	-1.25	+0.75
	MIN	-3.0	-3.5	-3.0	-1.0
1.0'	MAX	+1.75	-1.75	-1.75	+0.75
	MIN	-3.0	-3.0	-3.0	-0.50
RADIATION DISTANCE 0.0'	MAX	+1.75	-1.75	-1.25	+0.5
	MIN	-3.0	-2.75	-2.25	-0.5
1.0'	MAX	+1.0	-1.0	-1.0	+0.75
	MIN	-2.75	-2.75	-2.25	-0.75
1.5'	MAX	+1.0	+0.0	-1.0	+0.5
	MIN	-2.5	-2.5	-3.0	-0.5
2.0'	MAX	+1.5	+1.5	+1.5	+0.75
	MIN	-2.75	-2.75	-2.75	-0.75





RADIATION DISTANCE		TRANSMISSION LENGTH = 26.5'			
		RELATIVE POWER LEVEL (db) IN HORIZONTAL DISTANCES OF:			MAX. RIPPLE
		+2.0'	+1.5'	+1.0'	
2.0'	MAX	+2.25	-2.25	-2.25	+1.0
	MIN	-3.25	-4.25	-4.25	-1.0
1.5'	MAX	+2.5	-1.5	-1.5	+0.75
	MIN	-3.5	-3.0	-3.0	-0.5
1.0'	MAX	+1.75	-1.75	-1.75	+0.5
	MIN	-4.0	-3.0	-3.0	-1.0
RADIATION DISTANCE 0.0'	MAX	+1.75	-1.25	-1.25	+0.5
	MIN	-2.75	-2.75	-2.5	-0.25
1.0'	MAX	+1.5	-1.25	-1.25	+0.5
	MIN	-2.5	-2.5	-2.25	-0.5
1.5'	MAX	+0.75	+0.75	-0.75	+0.5
	MIN	-2.5	-2.25	-1.75	-0.5
2.0'	MAX	+1.5	+1.25	+1.5	+0.75
	MIN	-1.0	-3.0	-3.0	-0.75

RADIATION DISTANCE		TRANSMISSION LENGTH = 27.0'			
		RELATIVE POWER LEVEL (db) IN HORIZONTAL DISTANCES OF:			MAX. RIPPLE
		+2.0'	+1.5'	+1.0'	
2.0'	MAX	+2.0	-2.0	-2.0	+0.5
	MIN	-3.25	-3.25	-3.25	-0.5
1.5'	MAX	+2.0	-2.0	-1.0	+0.75
	MIN	-3.5	-3.0	-3.0	-0.75
1.0'	MAX	+2.5	-1.75	-1.75	+0.5
	MIN	-3.5	-3.5	-2.75	-0.5
RADIATION DISTANCE 0.0'	MAX	+2.25	-1.25	-1.25	+0.5
	MIN	-2.75	-2.5	-2.5	-0.5
1.0'	MAX	+1.5	-1.0	-1.0	+0.5
	MIN	-2.5	-2.5	-2.5	-0.5
1.5'	MAX	+0.5	+0.5	-0.5	+0.75
	MIN	-2.5	-2.25	-2.25	-0.75
2.0'	MAX	+1.5	+1.5	+1.5	+0.5
	MIN	-1.5	-2.75	-2.75	-0.5

Figure 22  
CHAMBER EVALUATION  
FREQUENCY: 3.45 GHZ  
TRANSMITTING HORN SECTION: D2  
RECEIVING ANTENNA: Absorber backed dipole

DATE: 8/22/66

NOTES:

-  = +0.25 - 2.25 = ± 1.25 db
-  = +0.25 - 2.75 = ± 1.5 db
-  = +0.25 - 3.25 = ± 1.75 db
-  = +0.25 - 3.75 = ± 2.0 db
-  = +0.25 - 4.25 = ± 2.25 db

~~SECRET~~

L R		TRANSMISSION LENGTH = 23.0'			
		RELATIVE POWER LEVEL (db) IN HORIZONTAL DISTANCES OF:			MAX. RIPPLE
		+2.0'	+1.5'	+1.0'	
2.0'	MAX	1.0	0.5	0.0	+0.5
2.0'	MIN	-1.5	-2.0	-2.5	-0.75
1.5'	MAX	1.5	1.0	0.5	+0.75
1.5'	MIN	-1.0	-1.5	-2.0	-0.75
1.0'	MAX	2.0	1.5	1.0	+0.5
1.0'	MIN	-0.5	-1.0	-1.5	-0.5
0.0	MAX	2.5	2.0	1.5	+0.25
0.0	MIN	0.0	-0.5	-1.0	-0.5
1.0'	MAX	3.0	2.5	2.0	+0.25
1.0'	MIN	-1.0	-1.5	-2.0	-0.25
1.5'	MAX	3.5	3.0	2.5	+0.25
1.5'	MIN	-1.5	-2.0	-2.5	-0.25
2.0'	MAX	4.0	3.5	3.0	+0.5
2.0'	MIN	-2.0	-2.5	-3.0	-0.5

L R		TRANSMISSION LENGTH = 23.5'			
		RELATIVE POWER LEVEL (db) IN HORIZONTAL DISTANCES OF:			MAX. RIPPLE
		+2.0'	+1.5'	+1.0'	
2.0'	MAX	1.0	0.5	0.0	+0.5
2.0'	MIN	-1.5	-2.0	-2.5	-0.5
1.5'	MAX	1.5	1.0	0.5	+0.5
1.5'	MIN	-1.0	-1.5	-2.0	-0.5
1.0'	MAX	2.0	1.5	1.0	+0.5
1.0'	MIN	-0.5	-1.0	-1.5	-0.5
0.0	MAX	2.5	2.0	1.5	+0.5
0.0	MIN	0.0	-0.5	-1.0	-0.75
1.0'	MAX	3.0	2.5	2.0	+0.5
1.0'	MIN	-1.0	-1.5	-2.0	-0.25
1.5'	MAX	3.5	3.0	2.5	+0.5
1.5'	MIN	-1.5	-2.0	-2.5	-0.5
2.0'	MAX	4.0	3.5	3.0	+0.25
2.0'	MIN	-2.0	-2.5	-3.0	-0.25

L R		TRANSMISSION LENGTH = 24.0'			
		RELATIVE POWER LEVEL (db) IN HORIZONTAL DISTANCES OF:			MAX. RIPPLE
		+2.0'	+1.5'	+1.0'	
2.0'	MAX	1.0	0.5	0.0	+1.0
2.0'	MIN	-2.0	-2.5	-3.0	-0.75
1.5'	MAX	1.5	1.0	0.5	+0.5
1.5'	MIN	-1.5	-2.0	-2.5	-0.5
1.0'	MAX	2.0	1.5	1.0	+0.5
1.0'	MIN	-1.0	-1.5	-2.0	-0.5
0.0	MAX	2.5	2.0	1.5	+0.25
0.0	MIN	0.0	-0.5	-1.0	-0.25
1.0'	MAX	3.0	2.5	2.0	+0.25
1.0'	MIN	-1.0	-1.5	-2.0	-0.50
1.5'	MAX	3.5	3.0	2.5	+0.25
1.5'	MIN	-1.5	-2.0	-2.5	-0.25
2.0'	MAX	4.0	3.5	3.0	+0.5
2.0'	MIN	-2.0	-2.5	-3.0	-0.5

L R		TRANSMISSION LENGTH = 25.0'			
		RELATIVE POWER LEVEL (db) IN HORIZONTAL DISTANCES OF:			MAX. RIPPLE
		+2.0'	+1.5'	+1.0'	
2.0'	MAX	1.0	0.5	0.0	+0.75
2.0'	MIN	-2.0	-2.5	-3.0	-1.0
1.5'	MAX	1.5	1.0	0.5	+0.75
1.5'	MIN	-1.5	-2.0	-2.5	-0.75
1.0'	MAX	2.0	1.5	1.0	+0.5
1.0'	MIN	-1.0	-1.5	-2.0	-0.25
0.0	MAX	2.5	2.0	1.5	+0.5
0.0	MIN	0.0	-0.5	-1.0	-0.5
1.0'	MAX	3.0	2.5	2.0	+0.5
1.0'	MIN	-1.0	-1.5	-2.0	-0.75
1.5'	MAX	3.5	3.0	2.5	+0.5
1.5'	MIN	-1.5	-2.0	-2.5	-0.75
2.0'	MAX	4.0	3.5	3.0	+0.5
2.0'	MIN	-2.0	-2.5	-3.0	-0.5

L R		TRANSMISSION LENGTH = 26.0'			
		RELATIVE POWER LEVEL (db) IN HORIZONTAL DISTANCES OF:			MAX. RIPPLE
		+2.0'	+1.5'	+1.0'	
2.0'	MAX	1.0	0.5	0.0	+0.75
2.0'	MIN	-2.0	-2.5	-3.0	-0.75
1.5'	MAX	1.5	1.0	0.5	+0.75
1.5'	MIN	-1.5	-2.0	-2.5	-0.75
1.0'	MAX	2.0	1.5	1.0	+0.75
1.0'	MIN	-1.0	-1.5	-2.0	-0.50
0.0	MAX	2.5	2.0	1.5	+0.75
0.0	MIN	0.0	-0.5	-1.0	-0.75
1.0'	MAX	3.0	2.5	2.0	+0.75
1.0'	MIN	-1.0	-1.5	-2.0	+0.50
1.5'	MAX	3.5	3.0	2.5	+0.5
1.5'	MIN	-1.5	-2.0	-2.5	-0.5
2.0'	MAX	4.0	3.5	3.0	+0.5
2.0'	MIN	-2.0	-2.5	-3.0	-0.75

L R		TRANSMISSION LENGTH = 26.5'			
		RELATIVE POWER LEVEL (db) IN HORIZONTAL DISTANCES OF:			MAX. RIPPLE
		+2.0'	+1.5'	+1.0'	
2.0'	MAX	1.0	0.5	0.0	+0.75
2.0'	MIN	-2.0	-2.5	-3.0	-0.75
1.5'	MAX	1.5	1.0	0.5	+0.5
1.5'	MIN	-1.5	-2.0	-2.5	-1.0
1.0'	MAX	2.0	1.5	1.0	+0.5
1.0'	MIN	-1.0	-1.5	-2.0	-0.5
0.0	MAX	2.5	2.0	1.5	+0.5
0.0	MIN	0.0	-0.5	-1.0	-0.5
1.0'	MAX	3.0	2.5	2.0	+0.75
1.0'	MIN	-1.0	-1.5	-2.0	-0.50
1.5'	MAX	3.5	3.0	2.5	+0.5
1.5'	MIN	-1.5	-2.0	-2.5	-0.5
2.0'	MAX	4.0	3.5	3.0	+0.5
2.0'	MIN	-2.0	-2.5	-3.0	-0.5

L R		TRANSMISSION LENGTH = 27.0'			
		RELATIVE POWER LEVEL (db) IN HORIZONTAL DISTANCES OF:			MAX. RIPPLE
		+2.0'	+1.5'	+1.0'	
2.0'	MAX	1.0	0.5	0.0	+0.75
2.0'	MIN	-2.0	-2.5	-3.0	-0.75
1.5'	MAX	1.5	1.0	0.5	+0.5
1.5'	MIN	-1.5	-2.0	-2.5	-0.5
1.0'	MAX	2.0	1.5	1.0	+0.75
1.0'	MIN	-1.0	-1.5	-2.0	-0.75
0.0	MAX	2.5	2.0	1.5	+0.5
0.0	MIN	0.0	-0.5	-1.0	-0.5
1.0'	MAX	3.0	2.5	2.0	+0.5
1.0'	MIN	-1.0	-1.5	-2.0	-0.75
1.5'	MAX	3.5	3.0	2.5	+0.5
1.5'	MIN	-1.5	-2.0	-2.5	-0.5
2.0'	MAX	4.0	3.5	3.0	+0.5
2.0'	MIN	-2.0	-2.5	-3.0	-0.5

Figure 23  
CHAMBER EVALUATION

FREQUENCY: 3.8 Ghz  
 TRANSMITTING HORN SECTION: D1  
 RECEIVING ANTENNA: Absorber  
backed dipole

DATE: 8/23/66

NOTES:

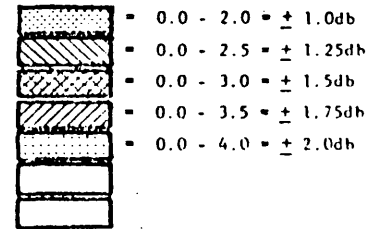

~~SECRET~~

~~SECRET~~

~~SECRET~~

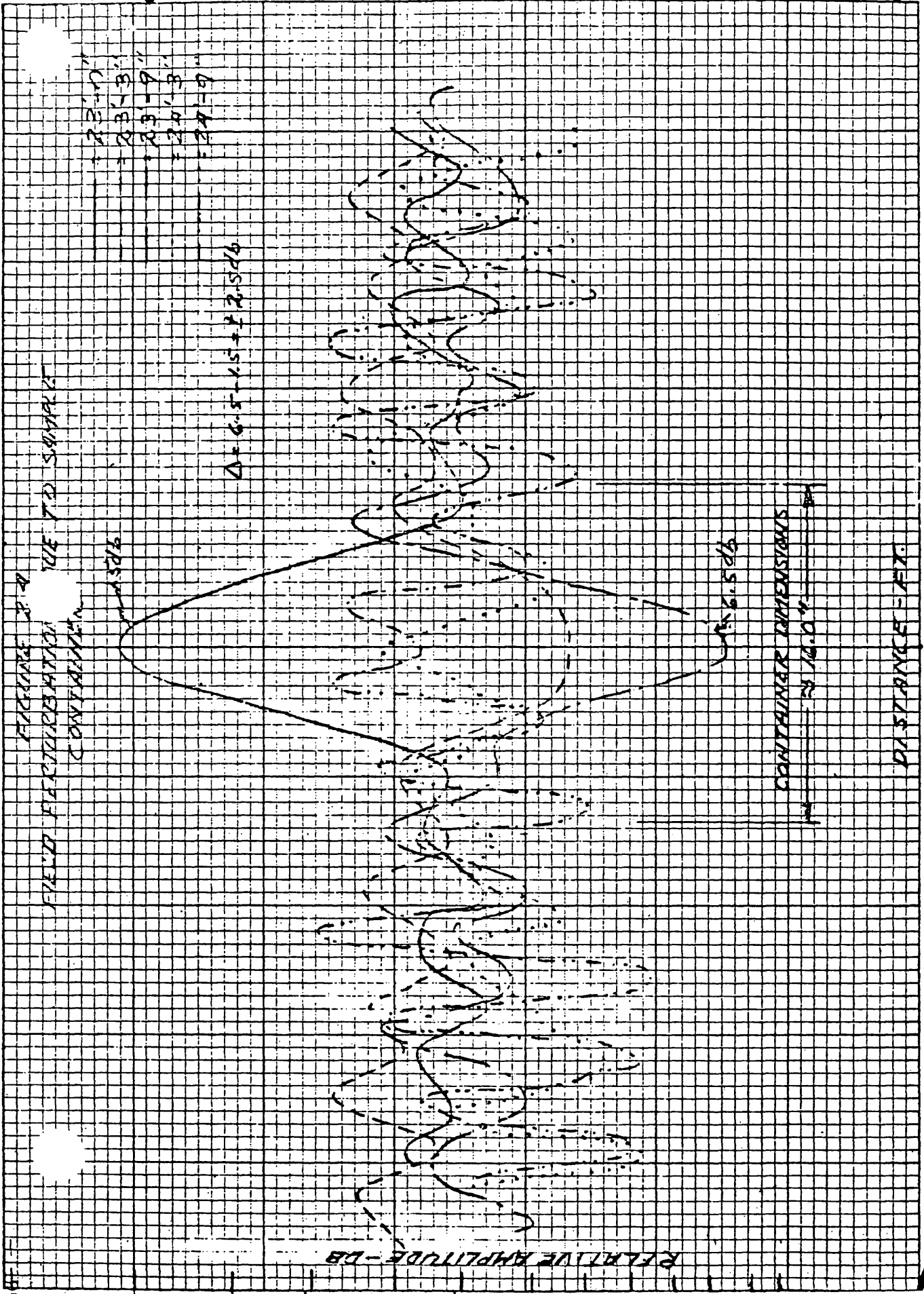

1.0 0 1.0 2.0

FIGURE 8-9  
SPEED PERTURBATION  
CONTAINER DIMENSIONS

~~SECRET~~

APPENDIX A

Transmitting Horn, Design and Test Results

INTRODUCTION

The anechoic chamber specifications originally called for a four foot cubic quiet zone; however, it was determined that a quiet zone 3' wide x 2' high x 1' deep would be suitable for two test samples in containers side-by-side. With a minimum transmitted power of 200 watts, a power density of  $2 \text{ mw/cm}^2 \pm 1.0 \text{ db}$  was required in the quiet zone. To allow for a margin of safety, a uniform illumination (within  $\pm 1.0 \text{ db}$ ) in a 4'W x 3'H x 2'D quiet zone was the design goal for the transmitting horn antenna.

A conical transmitting horn antenna design was chosen because it has an H plane to E plane beamwidth ratio close to that required (4 to 3), without the narrower beam in the intercardinal planes associated with the pyramidal horn antenna.

Because gain and beamwidth vary with the wavelength, the horn design incorporates "add-on" sections for the various incremental bandwidths. This is discussed further under beamwidth considerations. The first section includes a built-in rectangular to circular transition obviating the need for a separate waveguide transition. Figure 5 in the main section of this report is an illustration of the transmitting horn.

BEAMWIDTH CONSIDERATIONS

The geometry for the horn illumination of the quiet zone is shown in the following sketch.

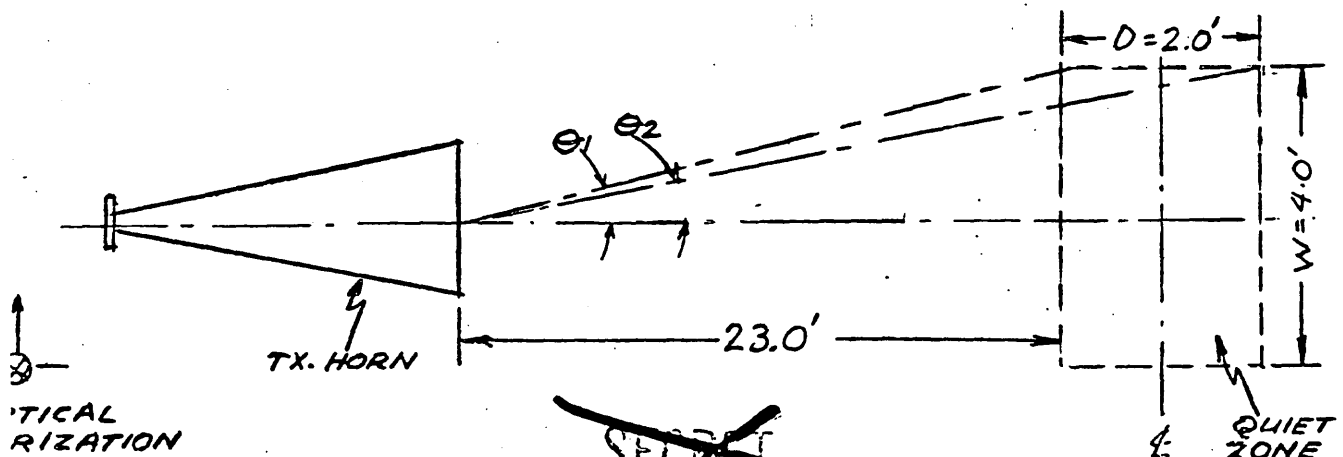

The chamber specifications called for a maximum of .5 db (± .25 db) change in amplitude due to reflections from the walls. This value, added to the .75 db (± .37 db) change in amplitude due to the change in transmission length ( $\frac{1}{R^2}$  loss), dictated that the change in amplitude due to the beamwidth of the transmitting horn could not exceed .75 db in order to meet the design goal of ± 1.0 db change in power density in the quiet zone volume. From the above sketch, then, the .75 db beamwidth is  $2 \theta_2 = 2 \tan^{-1} \frac{2}{25} = 9.2^\circ$ . From the figure in reference 3, the ratio of the .75 db beamwidth to the 3 db beamwidth is .5. Thus,

$$\frac{\theta_H(.75 \text{ db})}{\theta_H(3 \text{ db})} = .5 \quad \theta_H(3 \text{ db}) = \frac{\theta_H(.75 \text{ db})}{.5} = \frac{9.2}{.5} = \underline{\underline{18.4^\circ}}$$

The S-Band frequency range from 2 to 4 GHz was divided into eight increments, each representing approximately 10% of the band, in order to keep the beamwidth (and gain) nearly constant. To compensate for this ten percent bandwidth, the design beamwidth was increased by ten percent, resulting in a desired H plane 3 db beamwidth of  $20^\circ$ .

The horn aperture diameter in wavelengths ( $D/\lambda$ ) was determined from the approximate expression from the H plane beamwidth <sup>(4)</sup>.

$$\theta_H(3 \text{ db}) \approx \frac{70}{D/\lambda}$$

For  $\theta_H(3 \text{ db}) = 20^\circ$ ,  $D/\lambda = 3.5$ . Starting at 2.0 GHz, the approximate 10% incremental frequencies, wavelengths, and the diameter of the horn section computed from  $D/\lambda = 3.5$  are shown in Table A1. Also shown in this table are the lengths of the various sections computed from the geometry in the following sketch.

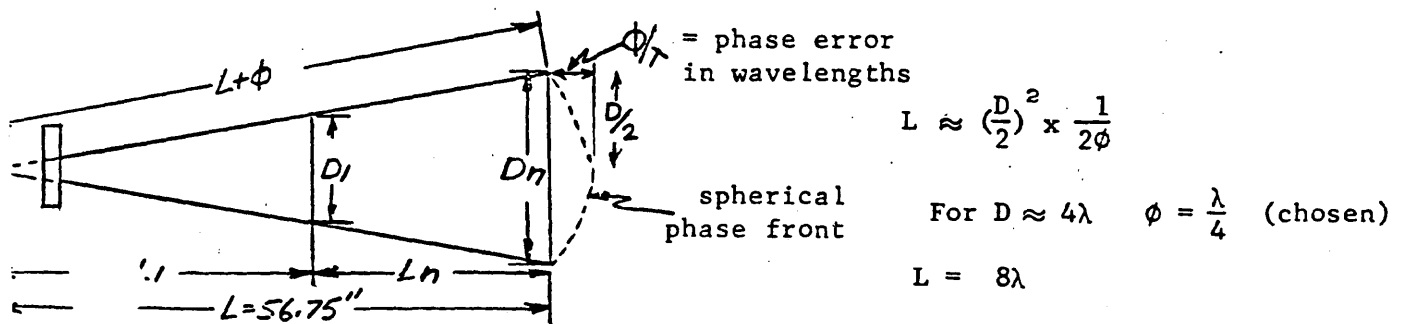

(3) The Microwave Engineers Handbook and Buyers Guide 1966, Page 174.  
 (4) Antennas J. D. Kraus McGraw Hill 1950, Page 381



Thus  $L \approx 8\lambda$  determined the lengths of the various sections as tabulated.

TABLE AI  
Horn Dimensions

Freq.	$\lambda$ (in.)	Diameter (in.) $D = 3.5\lambda$	Section Designation	$L_n$ (in.)
2.00	5.8	20.00	D8	21.5
2.20	5.35	18.75	D7	17.5
2.45	4.80	16.75	D6	14.0
2.70	4.35	15.25	D5	10.5
2.95	4.00	14.0	D4	7.50
3.20	3.70	13.0	D3	5.25
3.55	3.35	11.75	D2	2.25
3.90	3.05	10.75	D1	0

The recommended frequency range for S-Band WR 284 waveguide is 2.6 to 3.95 GHz, therefore horn sections larger than D6 may not be required. However, should higher power densities be needed (over smaller areas) horn sections D7 and D8, and two additional sections, D9 and D10 were constructed. The diameters for D9 and D10 are 22.5 "and 24.5", and the lengths are 26.75" and 31.75" respectively, based on the same criteria as the other sections.

GAIN REQUIREMENTS

The above analysis assumes an aperture with sufficient gain to provide a power density of  $2 \text{ mw/cm}^2$  for a minimum of 200 watts of transmitted power. Reference 5 gives the gain of a conical horn as  $G \text{ (db)} = 10 \log \left( \frac{4\pi A}{\lambda^2} \right) - L$ , where L is the loss term (in the reference figure) versus the phase deviation at the aperture edge. For the selected phase deviation of  $\lambda/4$ ,  $L = 1.5 \text{ db}$ ; and for  $D/\lambda = 3.5$

$$G = \left( \frac{\pi D}{\lambda} \right)^2 - 1.5 \text{ db} = 20.85 - 1.5 \doteq 19.4 \text{ db}$$

(5) Antenna Engineers Handbook H. Jasik, Ed. McGraw Hill (1961) Chap 10-4

The power density is

$$P_d = \frac{P_r}{A_r} = \frac{P_T G_T}{4\pi R^2} \quad \text{where } P_T = 200 \text{ watts (min)}$$

$$G_T = 19.4 \text{ db} = 87$$

$$R = 24 \text{ ft}$$

$P_d = 2.6 \text{ mw/cm}^2$ , which is adequate.

MEASURED VERSUS CALCULATED VALUES

The calculated gain (above) was 19.4 db at the design frequencies, which included a 1.5 db loss due to efficiency and phase error. The measured gains at the design frequencies are tabulated below along with the difference between the measured and calculated gain ( $\Delta G$ ).

TABLE A2

Measured versus Calculated Gain

Horn Section	Design Frequency	Measured Gain	Calculated Gain	$\Delta G$
D1	3.9	20.3	19.4	+0.9
D2	3.55	20.0	19.4	+0.6
D3	3.20	19.7	19.4	+0.3
D4	2.95	19.7	19.4	+0.3
D5	2.7	19.6	19.4	+0.2
D6	2.45	19.4(est)	19.4	+0.0

From this table, it can be seen that the measured gain is very slightly higher than calculated. This is due in part to the beamwidth being slightly narrower than the design value; and in part to the phase deviation at the aperture edge being less than  $\lambda/4$ , and consequently, the loss due to phase error and efficiency being slightly less than the 1.5 db allotted.

Table A3 below compares the measured and calculated 3 db beamwidths, which again are in good agreement. These values indicate that the expression for the H plane 3 db beamwidth is more nearly  $\theta_H (3 \text{ db}) \approx \frac{68}{D/\lambda}$  and for the E plane  $\theta_E \approx 55/D\lambda$ .

TABLE A3

Measured versus Calculated E & H Plane Beamwidths

Horn Section	Frequency (GHz)	Measured H Plane 3dbB.W (Degrees)	Calculated $\theta_H (3db) = \frac{70}{D/\lambda}$	Measured E Plane 3dbB.W (Degrees)	Calculated $\theta_E (3db) = \frac{60}{D/\lambda}$
D1	3.9	18.9	20°	15.8	17°
D2	3.55	19.3	20°	15.7	17°
D3	3.2	19.7	20°	15.7	17°
D4	2.95	19.6	20°	15.5	17°
D5	2.7	19.5	20°	15.5	17°
D6	2.45	19.5	20°	15.5	17°

~~SECRET~~  
 SECRET

## APPENDIX B

### Sleeve Dipole Antenna

A dipole was chosen as the field probe antenna for the chamber evaluation in order to observe virtually all of the reflections from the walls (and the ceiling and floor), which contribute to the perturbation of the field in the chamber. The sleeve (or skirt) dipole design was selected because of its natural configuration for an upright power monitor of a vertically polarized field, and because of its ease in construction utilizing the APL 5-spline semirigid coaxial cable which was available; the dipole probe tip simply screws into the cables hollow center conductor. The dipole is illustrated in figure B1. This figure gives the pertinent design dimensions which were arrived at empirically using the basic tenets set forth by Silver<sup>(6)</sup>.

Figure 13, in the main section of this report, illustrated the fixed monitor version of the sleeve dipole used as a power monitor in the chamber.

Figure B2 illustrates the "gooseneck" version used to evaluate the chamber.

The VSWR of both versions is shown in figure B3. These values include the mismatch from the Type N to 5-spline cable transition. A surprising feature of these dipoles is that the VSWR was less than 2:1 from 2.6 GHz to 11.4 GHz (the limits of the then available equipment).

---

(6) Microwave Antenna Theory and Design S. Silver, Ed.  
MIT Rad Lab Series, Vol 12 McGraw Hill (1949) Chap 8.2

~~SECRET~~

AT

Hopkins University  
PHYSICS LABORATORY  
Spring, Maryland

MRT-4-045  
QM-66-071

OPERATIONAL PROCEDURE FOR  
PROJECT PANDORA MICROWAVE  
TEST FACILITY

Prepared by  
E. V. Byron  
October 1966

ABSTRACT

This report describes the operational procedure for the Project Pandora microwave test facility. It is intended primarily for non-microwave oriented technical personnel to enable them to operate the facility with a minimum of training. Included is the Turn-On, Turn-Off Procedure, the procedure for measuring transmitted power and power density, and a description of the power monitors.

TABLE OF CONTENTS

<u>Section</u>	<u>Title</u>	<u>Page</u>
I.	Introduction	1
II.	Equipment Operation	1
	A. Preliminary Turn-On Procedure	2
	B. Operational Turn-On Procedure	3
	C. Turn-Off Procedure	4
III.	Procedure for Selecting Horn Sections, and Power for Desired Power Density	5
	A. Design Frequency Range for "Expandable" Conical Horn	5
	B. Horn Section for a Reduced Quiet Zone	6
IV.	Microwave Power Monitor	7
	A. Monitor No. 1	7
	B. Monitor No. 2 and Alternate Monitor No. 1	8

LIST OF ILLUSTRATIONS

<u>Figure No.</u>	<u>Title</u>	<u>Page</u>
1	Pandora Microwave Equipment Racks	9
2	Pandora Microwave Equipment - Functional Block Diagram	10
3	Power Density per Watt Transmitted for Each Horn Section	11
4	High Power Monitor - Meter Reading versus Transmitted Power	12
5	Received Power Density-Monitor Channel Number 1	13
6	Table of Horn Section Aperture Diameter	14



## I. INTRODUCTION

This report describes the operational procedure for the Project Pandora microwave test facility. It is intended primarily for non-microwave oriented technical personnel, to enable them to operate the facility with a minimum of training. Section II of this report delineates the basic turn-on, turn-off procedure for the equipment. Section III describes the procedure for determining which of the "add-on" sections of the expandable conical horn to use, and the power requirements for a desired power density. Section IV describes the power monitors in the microwave anechoic chamber.

The microwave equipment for Project Pandora is assembled in the four equipment racks illustrated in figure 1. Rack No. 1 contains the Spectrum Analyzer R.F. and Display sections. Rack No. 2 contains the auxiliary low-power microwave generation and modulation equipment. The equipment in this rack is not interconnected (nor is the spectrum analyzer). Rack No. 3 contains the primary low power microwave generation and modulation equipment, and the necessary monitoring and recording equipment. Rack No. 4 contains the high power microwave amplifier and power supplies. The interconnection of these two racks, with the "expandable horn" transmitting antenna in the anechoic chamber, is shown in figure 2 which is a functional block diagram of the microwave system.

## II. EQUIPMENT OPERATION

The following instructions pertain to the operation of the equipment assembled in equipment racks 3 and 4 with reference to figures 1 and 2.

Note: For operation of the various individual pieces of equipment, refer to the manufacturers' operation manuals which are available at the test facility.

A. Preliminary Turn On Procedure

Note: Connect the proper transmitting horn section for the required frequency and power density as outlined in Section III of this procedure.

1. Equipment Rack Number 4

- a. Turn on water supply. Pressure should be between 15 and 50 psi.
- b. Turn on low voltage A.C. power supply. Set Heater Voltage to 6.3 volts.
- c. Turn on D.C. power supply (solenoid power). Set to 33 volts.

Note: Under no circumstances should the solenoid be operated without water cooling or permanent damage will result. If the over current light is energized, the door interlock is open or there is insufficient water pressure or solenoid current.

- d. Set the Cathode Voltage switch on the high voltage power supply to the Burn-in position and turn on the high voltage.

Note: There is a 3 minute delay before the high voltage comes on. Allow 15 minutes warm-up.

2. Equipment Rack Number 3

- a. Turn on A.C. power to rack number 3.
- b. Turn the Grid Control on the Alfred 5-6868, 10 watt TWT amplifier to -250 volts. Turn Helix Control completely CCW.
- c. Turn HP692C Sweep Oscillator to Standby position.
- d. Turn on power to all equipment, allow 15 minute warm-up.

- e. Zero all HP431C power meters. For maximum accuracy, the power meters should be "re-zeroed" periodically. Refer to the HP431C instruction manual.
- f. Turn Sweep Oscillator Output Attenuator and TWT Output Attenuator completely CW (max. attenuation).
- g. Set HP692C to desired frequency and connect for desired modulation.

Note: Refer to the instruction manuals of the HP692, HP8403A, and the HP3300A for the possible modulation options and their settings. If the auxiliary low power R.F. generation and modulation equipment is to be used, refer to the appropriate instruction manuals for possible interconnections and operating instructions.

- h. Turn HP692C to Operate position.

B. Operational Turn On Procedure

1. Equipment Rack Number 4

- a. Set Cathode Voltage switch to the .1/3.3KV position and observe high voltage and current meters.

Note: Do not allow high voltage to exceed 3250 volts and the current to exceed 560 ma.

- b. If necessary, adjust high voltage screwdrive adjustment for high voltage meter reading of 3250 volts.  
DO NOT EXCEED 560 MA. CURRENT.

2. Equipment Rack Number 3

- a. Turn Helix Control on Alfred 5-6868 TWT completely CW.
- b. Turn Grid Control on Alfred 5-6868 TWT completely CW.

- c. Adjust Sweep Oscillator Output Attenuator for maximum power output as observed on TWT Monitor Power Meter. Lock in position.
- d. Adjust TWT Output Attenuator for the required transmitted power as observed on the TWT Monitor Power Meter. Lock in position.

Note: The transmitted power required for a desired power density can be determined from figure 3 and Section III of this procedure.

The transmitted power can be determined from the meter reading and figure 4; (High Power Monitor, - Meter Reading vs. Output Power).

DO NOT EXCEED 250 WATTS TRANSMITTED POWER FOR EXTENDED PERIODS OF TIME WITH THE INITIAL TUBE SUPPLIED.

- e. Set the monitor switches on the monitor switch panel to connect the desired function to be monitored to the strip chart recorder. The normal setting of these switches is TWT Monitor to the recorder channel No. 2, and Monitor Channel No. 1 to recorder channel No. 1.
- f. Connect "Available Inputs" to the scope or the HP415 as required.

C. Turn Off Procedure

1. Equipment Rack Number 3

- a. Turn 10 W TWT Output Attenuator max. CW (max. attenuation).
- b. Turn Sweep Oscillator Output Attenuator max. CW.
- c. Turn Grid Control on Alfred 5-6868 10 Watt TWT to -250 volts. Turn Helix Control completely CCW.

- d. Turn HP692C Sweep Oscillator to Standby position.
  - e. Rack power may now be turned off.
2. Equipment Rack Number 4
- a. Set the Cathode Voltage switch on high voltage power supply to Burn-in position.
  - b. Turn off high voltage.
  - c. Turn off low voltage A.C. power supply.
  - d. Turn off D.C. power supply.
  - e. Turn off water supply.

III. PROCEDURE FOR SELECTING HORN SECTION AND OUTPUT POWER FOR DESIRED POWER DENSITY

A. Design Frequency Range for "Expandable" Conical Horn

The microwave facility was designed such that a suitable quiet zone - minimum dimension, 3' wide by 2' high by 1' deep for two "test samples" side by side - would be illuminated uniformly a  $\pm 1.0$ db power variation in the quiet zone was the design goal. The quiet zone, as discussed in this report, starts at a transmission length of 23.0 feet and is symmetric about the chambers horizontal and vertical axis. These quiet zone dimensions, therefore, set the beamwidth characteristics of the transmitting horn; and a conical transmitting horn with "add-on" section was designed to give maximum gain with the required beamwidth over the S-Band frequency range. Under these conditions, figure 3 shows the "design frequency range" for the appropriate sections ( $D_1$  through  $D_6$ ). This figure is a plot of power density (in  $\text{mw}/\text{cm}^2$ ) per watt transmitted -  $P_d/W$  - versus frequency, for each of the horn sections. It can be seen that, for the design frequency ranges,  $P_d/W$  is  $1.6 \times 10^{-2} \frac{\text{mw}/\text{cm}^2}{\text{watt}} \pm 10\%$ .

Thus, for 250 watts transmitted, the power density in the quiet zone is  $4.0 \text{ mw/cm}^2 \pm 10\%$ .

1. To determine specifically the transmitted power required for a desired power density (at a given frequency in the design range):

a. Determine Pd/W for the known frequency and horn section from figure 3.

b. Solve:  $\text{Pd/W} \times \text{Power} = \text{Power density}$

$$\text{Power} = \frac{\text{Power density}}{\text{Pd/W}}$$

c. Example: At 3.0 GHz, a power density of  $2 \text{ mw/cm}^2$  is required. (Horn Section D<sub>4</sub>)

$$\text{Pd/W} = 1.58 \times 10^{-2} \text{ from figure 4.}$$

$$\text{Power} = \frac{2}{1.58 \times 10^{-2}} = 126 \text{ watts}$$

2. To determine power density from a known transmitted power:

a. Determine Pd/W for the known frequency and horn section from figure 3.

b. Solve:  $\text{Power density} = \text{Pd/W} \times \text{Power}$

c. Example: At 3.5 GHz, 200 watts are transmitted (Horn Section D<sub>2</sub>).

$$\text{Pd/W} = 1.56 \times 10^{-2} \text{ from figure 3.}$$

$$\text{Power density} = 1.56 \times 10^{-2} \times 200 = 3.13 \text{ mw/cm}^2$$

#### B. Horn Section for a Reduced Quiet Zone

To increase the versatility of the test facility, additional "add-on" horn sections were designed to uniformly illuminate successively smaller quiet zone volumes with increased gain. The determination of the quiet zone volume is dependent upon the beamwidth of the various sections and is beyond the scope of this report. Suffice it to say that, at the upper end of the frequency band (3.95 GHz) horn section D<sub>10</sub> will essentially illuminate uni-

formly a quiet zone large enough for a single test sample - 1.5'W x 1'H x 1'D. At this frequency,  $D_{10}$  gives the maximum power density obtainable for the system. As the frequency is decreased, horn section  $D_{10}$  will uniformly illuminate a proportionately larger volume with reduced gain.

1. The power required for a desired power density can be determined as in A1 above.

a. Example: 10 mw/cm<sup>2</sup> power density is desired at 3.95 GHz (Horn Section  $D_{10}$ )

$$\text{Power} = \frac{\text{Power Density}}{\text{Pd/W}}$$

$$\text{Pd/W} = 3.83 \times 10^{-2} \text{ from figure 3}$$

$$\text{Power} = \frac{10}{3.83 \times 10^{-2}} = 260 \text{ watts}$$

#### IV. MICROWAVE POWER MONITORS

In addition to the high power TWT monitor, there are 3 power monitors in the anechoic chamber. Two of these, Monitor #1, a standard gain horn, and Monitor #2, a sleeve dipole, are connected to the HP431C power meters in rack number 3. These two monitors may be switched to the Mosley 7100B strip-chart recorder (see figure 2). The third monitor, alternate monitor number 1, is a sleeve dipole and has an available output as shown in figure 2.

##### A. Monitor Number 1

Monitor number 1, the standard gain horn, is the primary "down stream" power density monitor. Power readings on the Channel No. 1 power meter can be converted to power density at the point of measurement with reference to figure 5.

Note: It must be reemphasized that this monitor, in conjunction with figure 5, measures the power density at the point where the monitor is placed in the chamber, and not the power density at the center of the quiet zone as determined in Section III.

B. Monitor Number 2 and Alternate Monitor No. 1

These monitors are available to measure relative power density and for the observation of signal waveforms at any point in the chamber.

By placing monitor number 2, with its alternate monitor line connected, at a point of known power density (previously determined as in Section III or IV A above), and placing alternate monitor number 1, at any other point in the chamber; a gross measurement of power density can be made by observing the relative readings. Due to the nature of the chamber reflections, the power density measured in this manner can be in error by  $\pm 2$  db; however, as a "gross" power density measurement technique, these monitors are useful since they are lightweight and easily movable.



RACK ARRANGEMENT OF PANDORA MICROWAVE EQUIPMENT

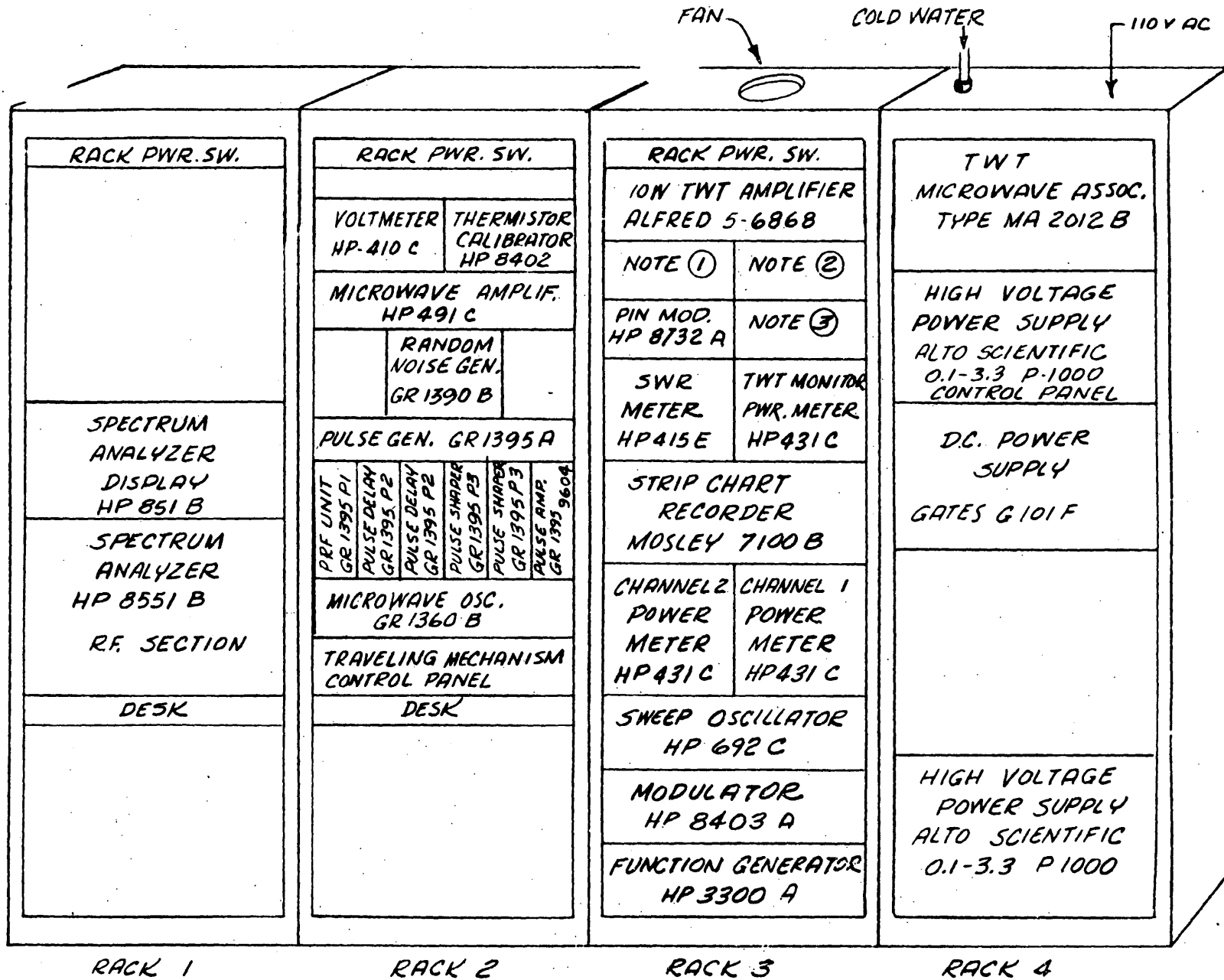

NOTE ① PANEL CONTAINS SWITCHES WHICH CONNECT VARIOUS MONITORED FUNCTIONS TO THE STRIP CHART RECORDER. BEHIND PANEL, BAND PASS FILTER (HP 8431 A), 20 db DIRECTIONAL COUPLER (HP 797D), 10db FIXED ATTN. (WEINCHEL 1-10N), XTAL DETECTOR (HP 423A).

NOTE ② ALFRED 5-6868 OUTPUT VARIABLE ATTENUATOR (NARDA 792).

NOTE ③ HP 692C SWEET OSC. OUTPUT VARIABLE ATTENUATOR (NARDA 792)

PANDORA MICROWAVE EQUIPMENT  
FUNCTIONAL BLOCK DIAGRAM  
FIGURE 2

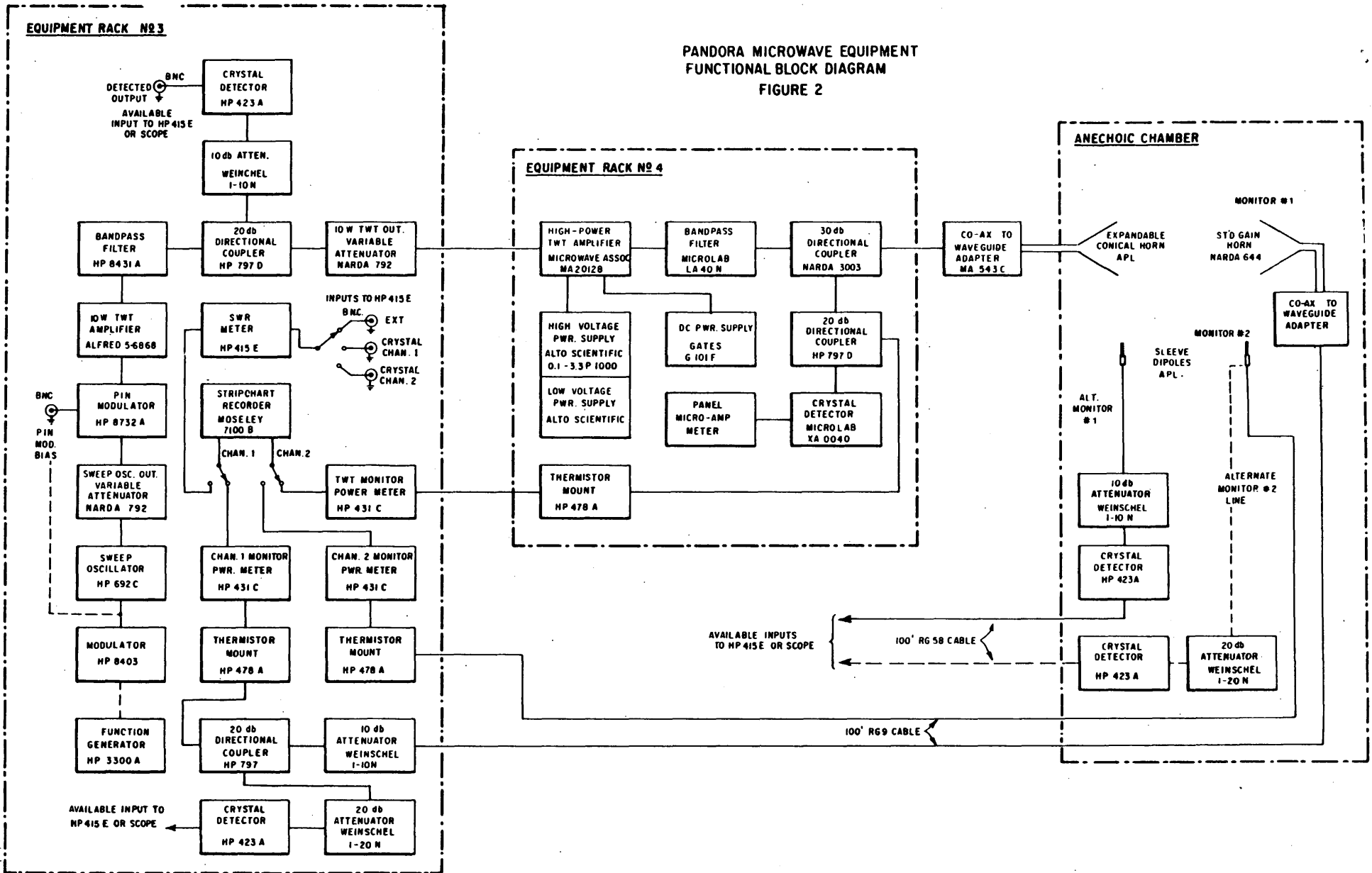
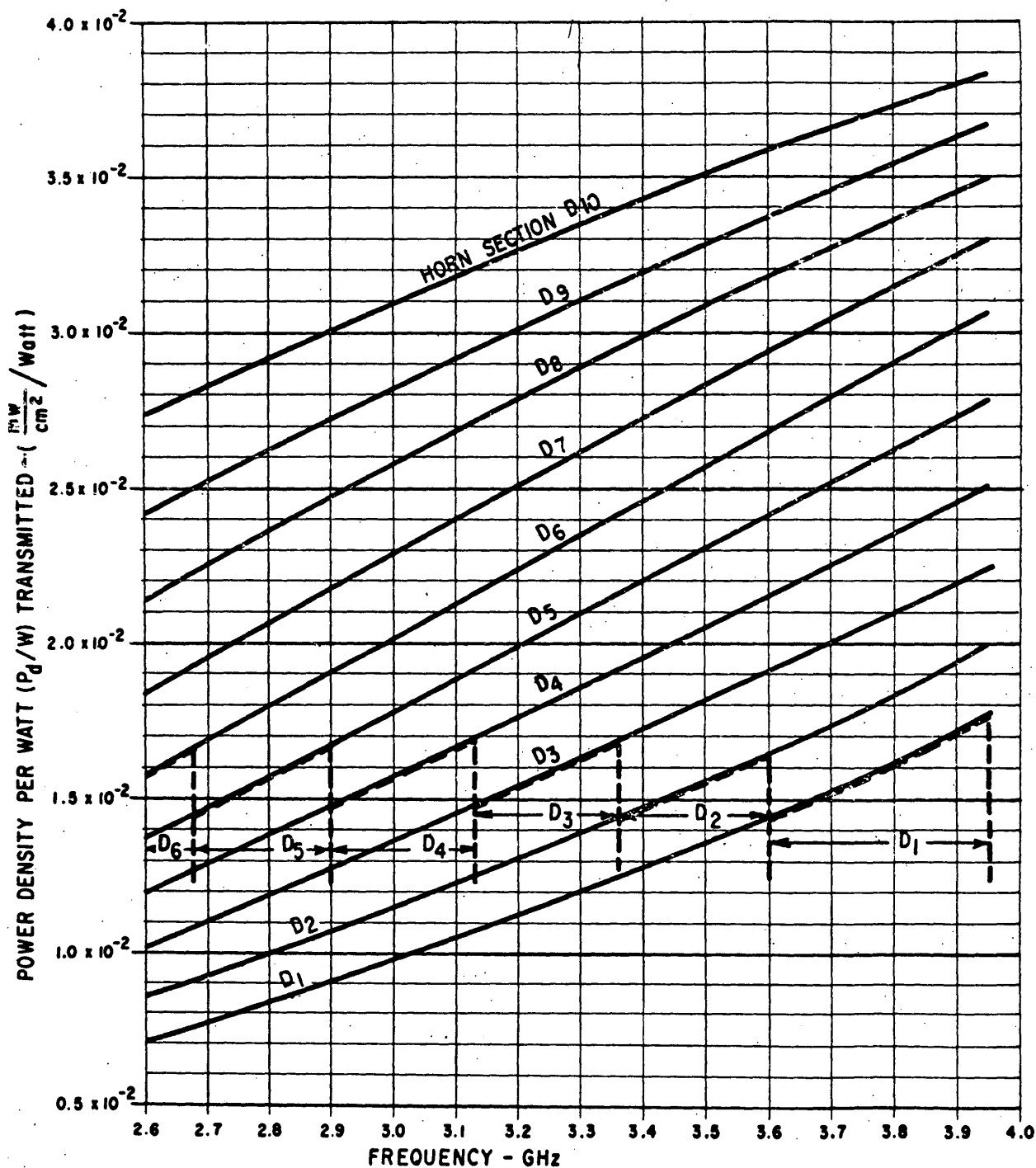
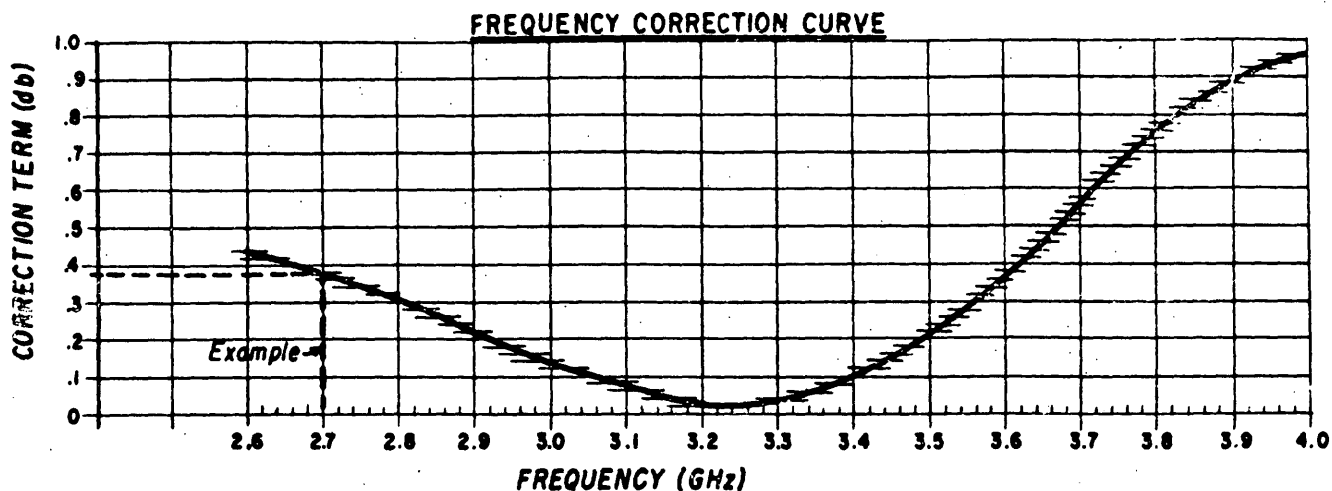

Fig. 3 POWER DENSITY PER WATT TRANSMITTED FOR EACH HORN SECTION



ARROWS SHOW FREQUENCY RANGES FOR EACH HORN SECTION

Fig.4 HIGH POWER TWT MONITOR - METER READING Vs TRANSMITTED POWER



**TO MEASURE TRANSMITTED POWER:**

ADD CORRECTION TERM TO TWT MONITOR POWER METER READING.

Example: AT 2.7 GHz, THE CORRECTION TERM = .38

POWER METER READING = 2.00

CORRECTED METER READING 2.38 dbm  $\approx$  140 Watts  $P_T$

**TO SET TRANSMITTED POWER:**

SUBTRACT CORRECTION TERM FROM CORRECTED METER READING WHICH CORRESPONDS TO DESIRED POWER. ADJUST POWER TO OBTAIN THIS VALUE ON TWT MONITOR POWER METER.

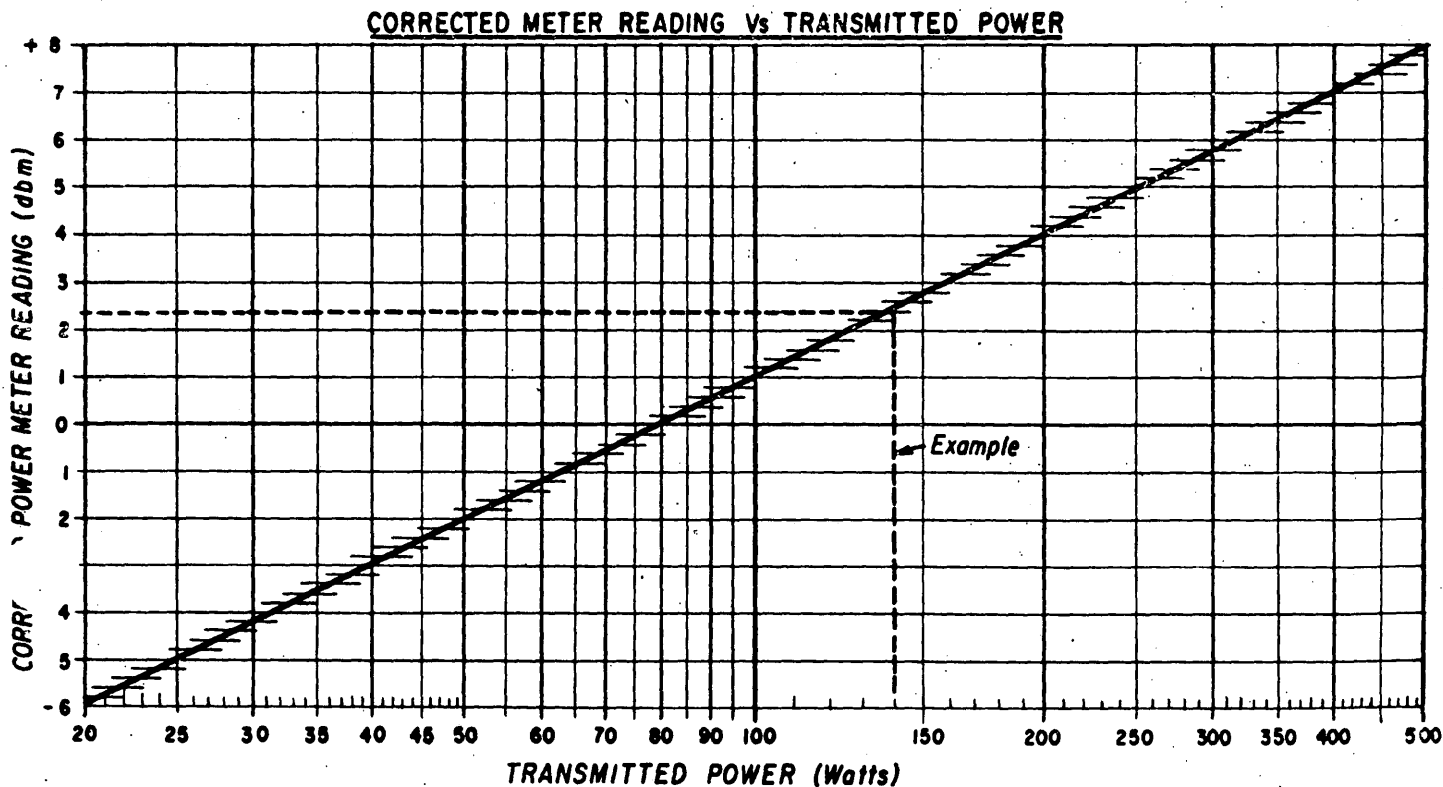

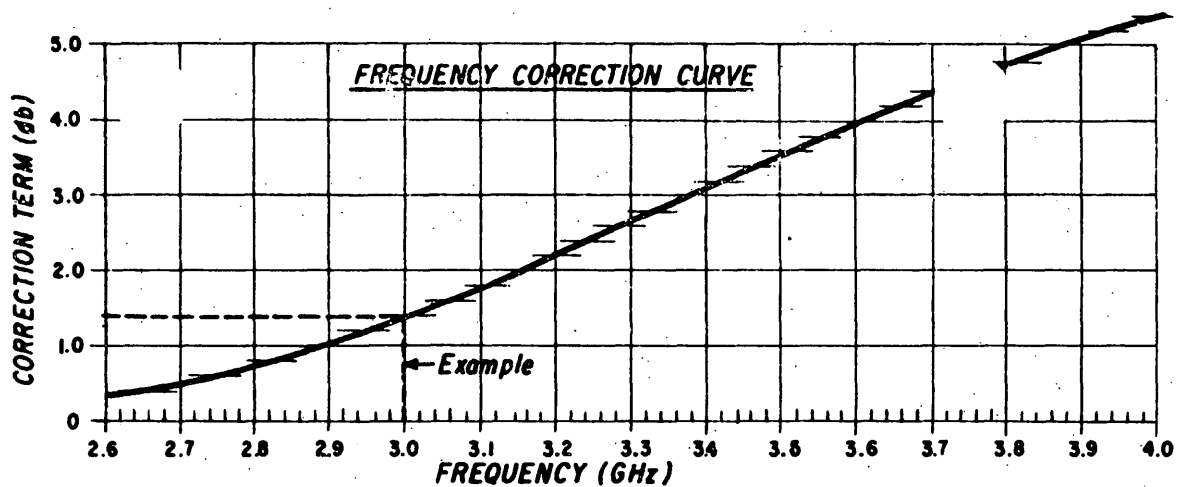

**TO MEASURE POWER DENSITY:**

ADD CORRECTION TERM TO METER READING

Example: AT 3.0 GHz, CORRECTION TERM = 1.4 db  
 METER READING = 3.0 dbm  
 CORRECTED METER READING = 4.4 dbm  
 4.4 dbm  $\approx$  3.0 Milliwatts/cm<sup>2</sup>

**TO SET POWER DENSITY:**

SUBTRACT CORRECTION TERM FROM METER READING WHICH CORRESPONDS TO REQUIRED POWER DENSITY. ADJUST POWER TO OBTAIN THIS VALUE ON MONITOR CHANNEL NO 1 POWER METER.

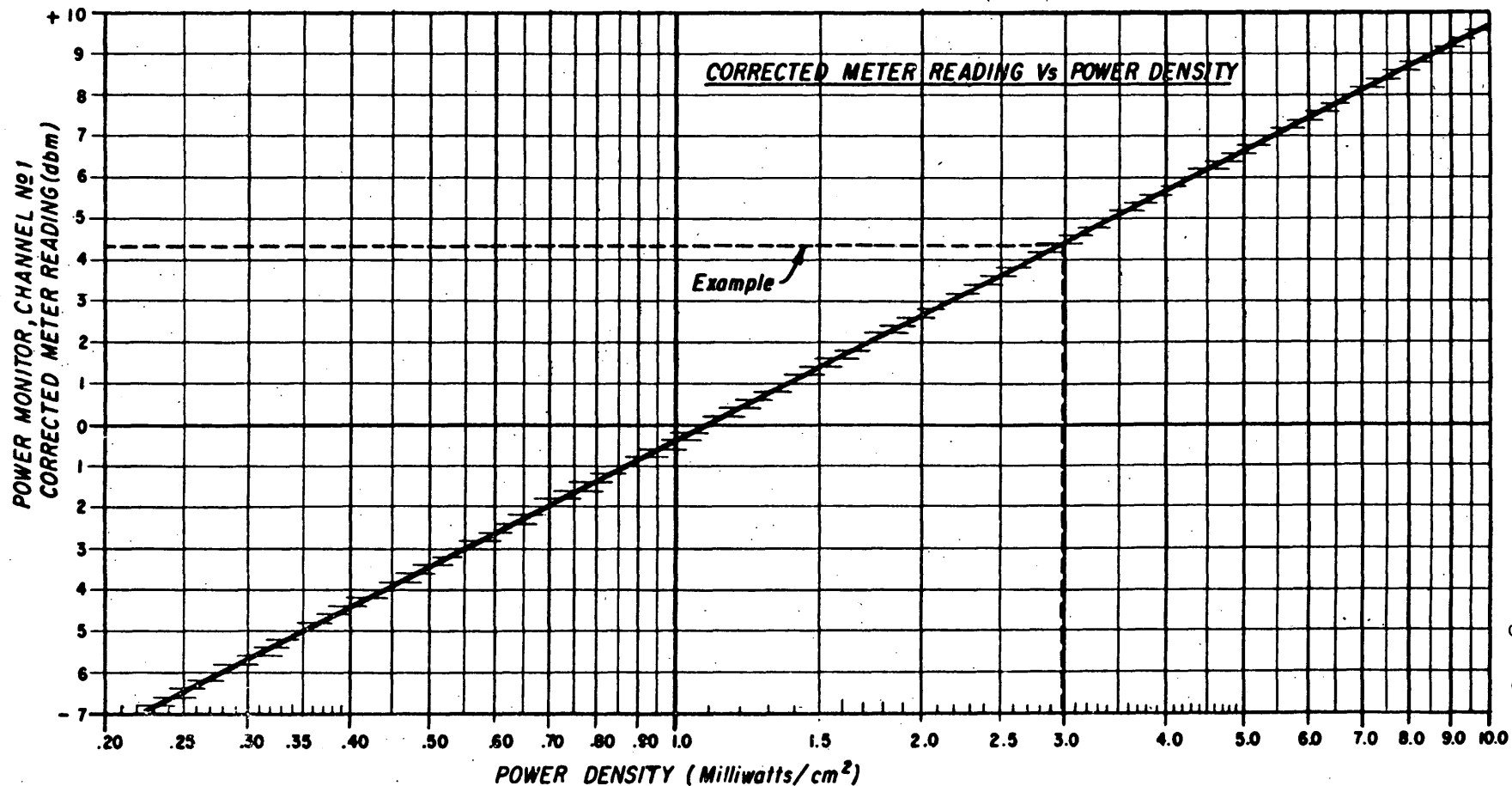

FIGURE 6

Horn Section Dimension

<u>Horn Section</u>	<u>Diameter (inches)</u>
D <sub>1</sub>	10.75
D <sub>2</sub>	11.75
D <sub>3</sub>	13.00
D <sub>4</sub>	14.00
D <sub>5</sub>	15.25
D <sub>6</sub>	16.75
D <sub>7</sub>	18.25
D <sub>8</sub>	20.00
D <sub>9</sub>	22.25
D <sub>10</sub>	24.5

External Distribution:

P. Tamarkin

R. S. Cesaro/5

H. M. Grove

R. W. Beard

F. Koether

J. Sharp

Internal Distribution:

R. E. Gibson/2

A. Kossiakoff

A. M. Stone

J. W. Follin/2

J. L. Queen

T. C. Cheston

E. V. Byron

Archives/2

MRT-4 File



External Distribution:

P. Tamarkin	Copy No. 1
R. S. Cesaro	2
R. S. Cesaro	3
R. S. Cesaro	4
R. S. Cesaro	5
R. S. Cesaro	6
H. M. Grove	7
R. W. Beard	W/o enclosures
F. Koether	W/o enclosures

~~SECRET~~  
~~SECRET~~