

LN190-91

CHINESE JOURNAL OF SOMATIC SCIENCE, July 1990, pp. 32-35

INVESTIGATION INTO THE "FORCE" IN PARAPSYCHOLOGICAL WRITING

BY: Huang Jinggen, Yu Xinghai and Shao Laijing

(Fudan University)

ABSTRACT

This article discusses use of a mechanical balance, a thermobalance and piezoelectric crystal to study the "force" in parapsychological writing. Within the scope of measurements during the experiment, no measurable "force" was observed during parapsychological writing. The authors discuss the results in the light of wave and particle dualism of matter.

"Parapsychological writing" is one form of human paranormal ability which has been demonstrated by a large number of experiments (1-5). "Parapsychological writing" includes a number of complex parapsychological phenomenon including moving the writing instrument, breaking through spacial barriers and thought directed writing. These paranormal phenomenon cannot be explained using modern scientific knowledge. However, the recording of paranormal phenomena, especially of the accumulation of data on experiments conducted using strict scientific methods must eventually approach and disclose the truth about this unknown realm. In "parapsychological writing" is there a "force" which corresponds to the movements of the "writing"? This is a major topic in the thoroughgoing research into parapsychological writing. The authors used a mechanical balance, a thermobalance and piezoelectric crystal to investigate the force in parapsychological writing. We discovered that it was a type of "imaginary force" that accompanies the movements of parapsychological writing. Within the parameters of measurement in the experiment, there was no common physical measurable quality.

THE EXPERIMENTS

1. THE MECHANICAL BALANCE

The balance was a semiautomatic TG328B balance. It has a glass cover. Its lower limit is 0.1 mg. On the left hand plate of the balance we placed a plastic film canister. Inside the film canister we placed a square of white paper. The lid to the film canister was open just a crack. On the right hand plate of the balance we placed a weight piece of equal weight so the balance would be kept level with the pointer at the zero marking (see

LN190-91

illustration one). After observing for five minutes, there was no movement in the pointer. However, it would move if one less or one more mg weight piece would be added. On a concrete platform outside the balance cover we placed a fountain pen. The test subject was Little Ji. The experiment required that she use her thought to "write" or "draw" on the paper in the film canister with a black ink fountain pen. She was to concentrate her thoughts on this to the exception of everything else. We conducted a total of nine experiments, of which three were successful. Each experiment lasted for 15 to 25 minutes. The words and drawings were all black like the ink in the fountain pen used in the experiment. In the three successful experiments, two had clear characters and drawings (see illustration two) and the other had fairly blurry circles and dots. Neither of two observers saw the mechanical balance move at all, demonstrating that the film canister was not under any observable "outside force".

ILLUSTRATION ONE: DIAGRAM OF THE MECHANICAL BALANCE

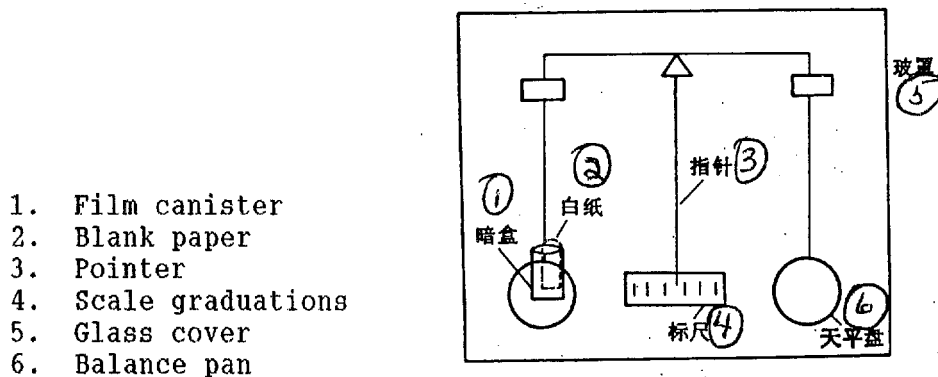
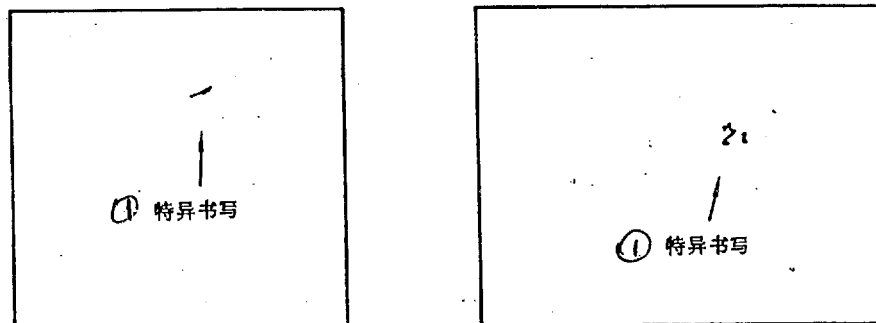

ILLUSTRATION TWO: RESULTS WITH MECHANICAL BALANCE



A. 8 MAY 1989

12 MAY, 1989

1. Parapsychological writing

LN190-91

2. THE THERMOBALANCE

A thermobalance is an instrument which gives a continuous recording of the relationship between mass and temperature. Normally, the procedure is to control the temperature by heating or cooling the sample material or to maintain the sample at a constant temperature. In our experiments, the temperature was constant at room temperature, and the lowest measurable unit was 0.05 mg. Illustration three shows a diagram of the arrangement. In the experiment a blank piece of tape was stuck to the crucible arm, the arm was covered with a glass tube to keep air currents from affecting the experiment. The test subject, Little Ji, sat at the edge of the table 0.5 meters from the balance with her back to the instrument. On the table we placed a fountain pen (to discriminate colors we used fountain pens with blue and green ink). The experiment required that the subject use her thoughts to "write" on the white tape with the fountain pen. During the experiment, those administering the experiment always observed the progress of the experiment from the side, and the automatic recorder drew the weight/time graph. Ten experiments were conducted in all, and three of these were successful. Each experiment lasted approximately 20 minutes. The "writing" was always dots and the same color as the ink used in the fountain pens in the experiment. On one occasion the "writing" was green, and on two occasions it was blue.

ILLUSTRATION THREE: DIAGRAM OF THERMOBALANCE ARRANGEMENT

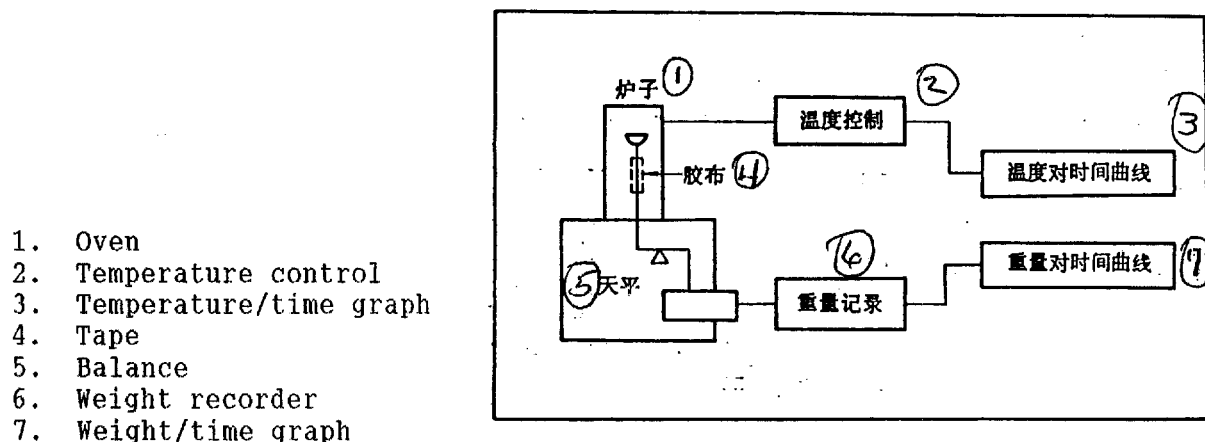

1. Oven
2. Temperature control
3. Temperature/time graph
4. Tape
5. Balance
6. Weight recorder
7. Weight/time graph

Illustrations four and five show the dots "written" on the tape mentally by Little Ji. The automatic recorder weight/time graph came out as a straight line. There was no change in weight, demonstrating that there was no function of "force" in the "parapsychological writing".

LN190-91

ILLUSTRATION FOUR: RESULTS OF THE THERMOBALANCE EXPERIMENT. 20 MARCH, 1989
THE "PARAPSYCHOLOGICAL WRITING" DOT WAS BLUE

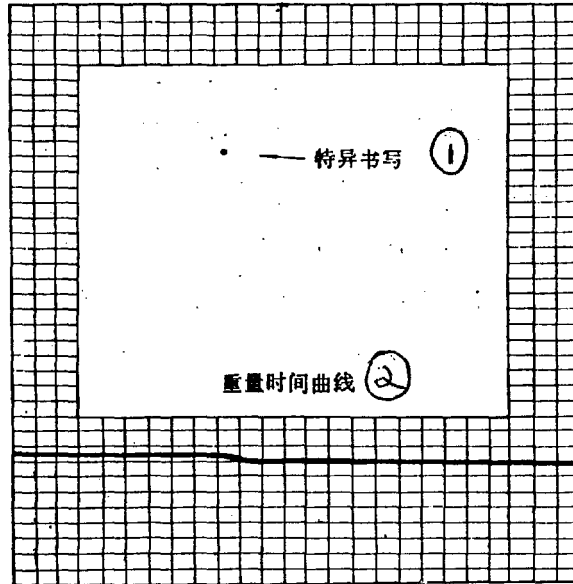
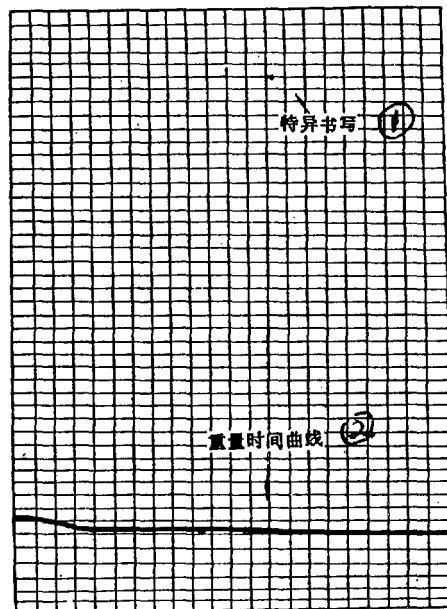

ILLUSTRATION FIVE: RESULT OF THERMOBALANCE EXPERIMENT 18 APRIL, 1989
THE "PARAPSYCHOLOGICAL WRITING DOT WAS GREEN.



1. Parapsychological writing
2. Weight/time graph

LN190-91

3. THE PIEZOELECTRIC CRYSTAL

The arrangement for the experiment was as shown in illustration six. The experiment was conducted using four subjects with parapsychological abilities in turn. A square piece of blank paper was stuck to a piezoelectric ceramic strip in a paper box (in some of the experiments, double faced carbon paper was inserted between the piezoelectric crystal and the blank paper). The experiment required the subjects to use their thoughts to write a line or character on the blank paper. In the ten successful experiments, there was no electrical signal transmitted by the piezoelectric detector (see illustration seven), demonstrating that the piezoelectric sensor was not able to detect the force of the "parapsychological writing" no difference could be detected either when the fountain pen was "present" or "not present" on the piezoelectric crystal.

ILLUSTRATION SIX: DIAGRAM OF ARRANGEMENT OF PIEZOELECTRIC CRYSTAL EXPERIMENT

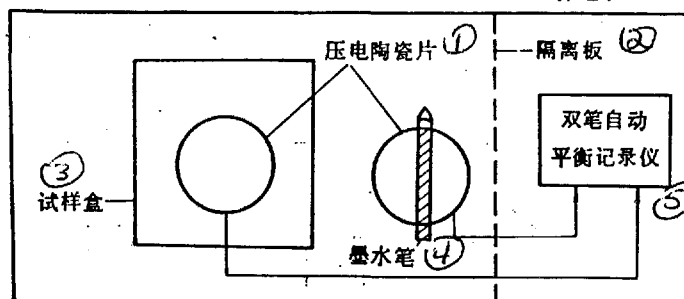

1. Piezoelectric crystal
2. Isolation board
3. Sample box
4. Fountain pen
5. Double line automatic balance recorder

We suspected that the subjects with parapsychological abilities might be able to transmit some kind of signal energy during the parapsychological writing experiment that would cause the a break in the signal given off by the piezoelectric crystal. Therefore, we used two piezoelectric plates glued together. One plate transmitted a low frequency alternating current signal, and the other plate was used for the parapsychological writing. The signal was the superimposition of the two individual signals. If the electrical signal was cut off, there would be a break in the low frequency signal on the recorded graph. However, this never happened. Therefore, such suspicions were eliminated.

LN190-91

ILLUSTRATION SEVEN: PIEZOELECTRIC CERAMIC EXPERIMENT.
THE "PARAPSYCHOLOGICAL WRITING" IS A HORIZONTAL LINE, BUT THE
PIEZOELECTRIC PLATE DID NOT GIVE OFF ANY SIGNAL

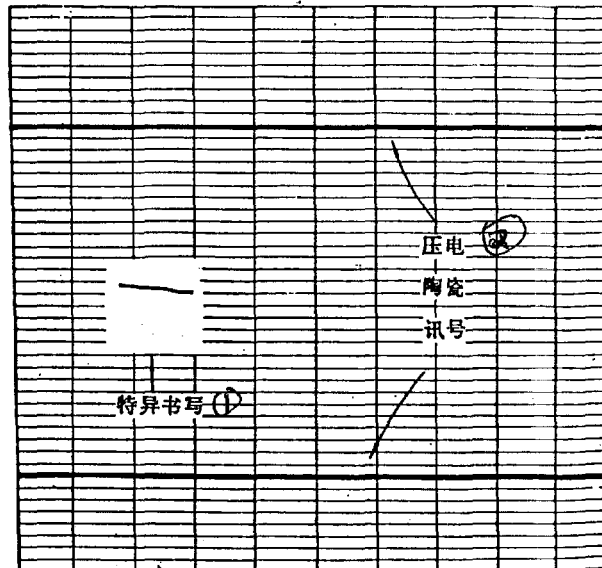

1. Parapsychological writing
2. Piezoelectric ceramic signal

DISCUSSION

The results of the experiments with the mechanical balance, thermobalance and piezoelectric crystal are combined in table one. From these experiments we can reach the following conclusions. 1. There is no observable "external force" functioning in "parapsychological writing" or 2. If an "external force" is playing a role, then it occurs extremely quickly so the recorder or the balance does not have time enough to react. We used our hand and paper to test the experiment instruments maximum speed (about five mg over 0.1 second), and the instruments were always able to record or react to the stimulus. Therefore, if there actually is a "external force" at work in "parapsychological writing" it works over a time of less than 0.1 second. However, considering that prior to the subjects with parapsychological abilities completing the "parapsychological writing", they must still go through the process of "moving the pen" and "breaking through the spacial barrier", and it seems that the possibility is not very great that all these actions are not detectible or "recordable" because they happen too quickly. Therefore, we lean toward the conclusion that there is no "external force" at work in "parapsychological writing".

The actions "moving the pen", "breaking through spacial barriers" and "effortless writing" in the process of "parapsychological writing" cannot be explained using current knowledge. We envisage that "wave and particle

LN190-91

dualism of nature" may be one way to explain it. First, we hypothesize that: If, just as microscopic particles such as photons, electrons and neutrons have dual wave and particle natures, so do macroscopic bodies (such as matter) have dual wave and particle natures, then such matter waves could be viewed as the macroscopic layer de Broglie wave, and according to the principles of quantum physics, only moving particles have "wave" characteristics. Thus, here we hypothesize that macroscopic matter at rest also has a wave nature. This first of all, already is a change to the concepts of quantum physics. Presently, there is no experimental basis for such a change. There is only a hypothesis, a hypothesis to explain the phenomenon of paranormal abilities.

TABLE ONE: COMBINED RESULTS FROM THE EXPERIMENTS WITH THE MECHANICAL BALANCE, THERMOBALANCE AND THE PIEZOELECTRIC CRYSTAL

	Number of experiments	Number of successful experiments	Contents of parapsychological writing	Force function
Mechanical balance	9	3	Symbols and horizontal lines	None
Thermobalance	10	3	Dots	None
Piezoelectric crystal	More than 20 times	10	Symbols and horizontal lines	None

It is currently generally believed that "persons with paranormal abilities" can only manifest "paranormal phenomenon" when they enter a "functional state." If the state which normally exists were called the "basic state", then the "functional state" could be called the "state of excitation". We hypothesize that the "state of excitation" is not a single state but a multiplicity of states, and the person with paranormal abilities carries out "paranormal actions" under different "states of excitation." That persons with paranormal abilities transmit "thought waves" of different frequencies under different "states of excitation." When these "thought waves" come into resonance with the "matter waves" of the object being used, the "matter waves" dispersed by the matter in a condensed state being used will be greatly increased from their original very small amount. When the person with paranormal abilities conducts "parapsychological writing", from what they tell us, they first use their thoughts to imagine the "pen" and when

LN190-91

the "pen" appears in their "mind", they imagine the object on which the pen is to write (paper, tape, etc). Finally, the "pen" will suddenly write or make a mark on the paper or tape in their minds with a flash and the process is over. There are also times when the person will use thought to image the paper or tape and then to imagine the "pen", and finally the flash described above. Generally, the person need only see the objects in the mind and finally to have the "flash, and the experiment is usually a success. We feel that the thought imagining of the person with paranormal abilities is the process of entering the "state of excitation". When the "imagined" object appears in the "mind", the wave band of the "state of excitation" which the subject has entered is in resonance with the "matter wave" of the object being imagined. With different objects being imagined, the subjects enters different "states of excitation. Only when the object being imagined appears in the mind of the subject is there any possibility of success. It would seem that the corresponding resonance of the "thought waves" of the "state of excitation" and the "matter waves" might be an major condition for "paranormal abilities" to occur. Because of the resonance, the "matter waves" will be much stronger, and using the "pen" for example, after the "pen" waves have been greatly intensified, they will pass through the "spacial barrier" and "act" on the blank paper or tape. Only when this type of "force" has reached a certain intensity will the "pen" be able to make a mark on the blank paper. This is the final "flash" in the mind of the person with paranormal abilities. However, this final "flash" may also be hypothesized to be the person with paranormal abilities entering a new "state of excitation", The "thought waves" of this "state of excitation" could cause the "pen's" "matter waves" to and the "paper's" "matter waves" in the subjects mind to produce an effect and result in "writing" being produced on the paper (this situation is similar to the effect of a catalyst in chemistry). Because the effect is produced in the form of waves, it would not have any measurable mass, and although there would be signs of "writing" left behind, it would not manifest any quantity of "force".

The discussion above, is actually only an hypothesis, and our purpose is to throw out some initial ideas to attract others' opinions and to open up the avenue of new thinking.

The discussion portion of this work was accomplished with the participation of comrades Yan Yuanzhuang, Fang Linhu, Zhou Yingqi, Zeng Siding and Ni Dexiang who all provided their valuable opinions. We take this opportunity to express our appreciation.

BIBLIOGRAPHY

1. Joint Testing Group for Somatic Paranormal Abilities, "Research in Somatic Paranormal Abilities", 1(1983)19.
2. He Qingnian and others, *ibid*, 2(1984)58
3. Shao Guangda, *ibid*, 1,2(1985)17
4. Zhang Ming and others, *ibid*, 1,2(1987)9
5. Weng Taimeng and others, *ibid*, 1(1989)14



DEFENSE INTELLIGENCE AGENCY
WASHINGTON, D. C. 20301



TRANSLATION

REQUESTER DT-S	TRANSLATOR'S INITIALS ST	TRANSLATION NUMBER LN190-91	DATE COMPLETED 13 Apr 91	ENCL(S) TO IIR NO.
LANGUAGE Chinese	GEOGRAPHIC AREA (If different from place of publication) PRC			
ENGLISH TITLE OF TRANSLATION Investigation into the "Force" in parapsychological writing			PAGE NOS. TRANSLATED FROM ORIG DOC. 32-35	
FOREIGN TITLE OF TRANSLATION				
AUTHOR(S)		FOREIGN TITLE OF DOCUMENT (Complete only if different from title of translation)		
PUBLISHER		DATE AND PLACE OF PUBLICATION PRC, July 1990		
COMMENTS				
TRANSLATION				