



DEFENSE INTELLIGENCE AGENCY
WASHINGTON, D. C. 20301



TRANSLATION

REQUESTER DT-S	TRANSLATOR'S INITIALS ST	TRANSLATION NUMBER LN190-91	DATE COMPLETED 22 Mar 91	ENCL(S) TO I R NO.
LANGUAGE Chinese	GEOGRAPHIC AREA (If different from place of publication) People's Rep. of China			
ENGLISH TITLE OF TRANSLATION Chinese Journal of Somatic Science			PAGE NOS. TRANSLATED FROM ORIG DOC. All	
FOREIGN TITLE OF TRANSLATION Zhongguo Renti Kexue				
AUTHOR(S)		FOREIGN TITLE OF DOCUMENT (Complete only if different from title of translation)		
PUBLISHER			DATE AND PLACE OF PUBLICATION PRC, July 1990	
COMMENTS				

TRANSLATION

Duplication

REMARKS
ON COPY

CHINESE JOURNAL OF SOMATIC SCIENCE
[ZHONGGUO RENTI KEXUE]

FIRST ISSUE, JULY, 1990

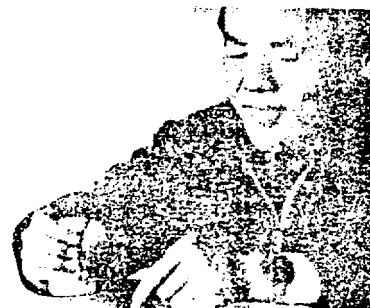

ILLUSTRATION 9.1

FRAME ONE: THERE ARE TWO TABLETS ON THE TABLE, BOTTLE HELD IN RIGHT HAND

ILLUSTRATION 9.2

These are frames two and 2.5 milliseconds later. Slightly above the bottom of the bottle there is two-thirds of a tablet.

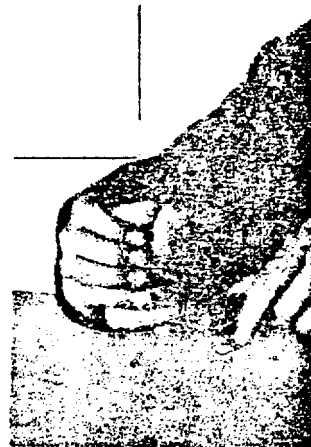

ILLUSTRATION 9.3

Frame three. The tablet is completely free of the bottle.



ILLUSTRATION 9.4

Frame four: Tablet continues to drop, but has not hit the table yet.

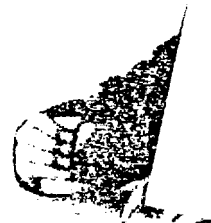

SOMATIC SCIENCE (SCIENCE OF THE HUMAN BODY)

Somatic science is the science of man in his cosmic environment. In the language of systems science, the human body is considered to be an open complex giant system. Here "open" refers to the human body environment and "giant" means the number of constituent elements number in the billions and billions. "Complex" means there are also many different types of constituent elements and there are a great number of interactions among the different elements. Somatic science thus differs in its basic viewpoint from the classical reductionist physiology. This indicates that somatic science is different from botany and biology, and also separates somatic science from what is commonly called life sciences.

"Somatology" is an old term. Here, its meaning is limited to the basic science and technology of somatic science. It is also a synthesis of classical physiology, modern psychology, psychophysiology, neuroscience, the scientific elements of Chinese traditional medicine and Qigong (Transcendental meditation) and other related subjects such as ESP and PK. The quasi-stable states of the human body system such as walking, sleeping and Qigong are called the somatic Eigen state.

For a philosophy of somatic science, the anthropic principles of Robert H. Dicke and Branden Carter, which were derived from cosmological considerations, can be extended to the microscopic scale to include the quantum theory of measurement and quantum epistemology and to the macroscopic scale to include the fundamental principles of Chinese traditional medicine.

CHINESE JOURNAL OF SOMATIC SCIENCE

FIRST ISSUE (JULY 1990)

TABLE OF CONTENTS

REMARKS ON THE FIRST EDITION
BY: Zhu Runlong, Zhu Yiui.....5

SPECIAL PAPERS

SOMATIC SCIENCE - IMPORTANT FRONTIERS LEADING TO BREAK-THROUGHS
IN MODERN SCIENCE.....9

BREAK-THROUGHS OF CURRENT SCIENCE
The Chinese Society of Somatic Science (CSSS).....9

THE HUMAN BODY - CONCEPTS AND METHODS OF OPEN COMPLEX GIANT SYSTEM
BY: Chen Xin.....19

EXPERIMENTAL RESEARCH

RESEARCH IN THE BREAK THROUGH OF SPACIAL OBSTACLES
BY: Song Kongzhi and others.....41

INVESTIGATION INTO THE "FORCE" OF PARAPSYCHOLOGICAL WRITING
BY: Huang Jinggen and others.....59

HYPOTHESIZING AND EXPLORING

EVIDENCE OF THE EXISTENCE OF ABNORMAL STATES OF MATTER
BY: Wu Banghui.....67

CONFERENCE REPORT

SPEECH TO SECOND RESEARCH CONFERENCE OF CSSS
BY: Zhang Zhenhuan.....71

THE SECOND RESEARCH CONFERENCE OF THE CSSS
BY: Qin Yue.....

COMMENTS ON NEW BOOKS (REVIEW OF "FOUNDING OF SOMATIC SCIENCE")
BY: Rong Wen.....80

TRANSLATED DIGEST

STUDIES OF THE HUMAN SUPER-PERCEPTION FUNCTION IN RUSSIA
TRANSLATED BY: Li Huang.....84

INFORMATION AND TRENDS

THE CHINESE MEDICINE SYSTEMATIC THEORY COMMITTEE ANNOUNCES
SYMPOSIUM TO BE HELD IN NEAR FUTURE
BY: Zhong Xuan.....

READING GUIDE
BY: The Editorial Department.....

CHIEF EDITOR: Zhu Runlong
ASSOCIATE EDITOR: Zhu Yiyi

REMARKS ON THE FIRST EDITION

BY: Zhu Runlong and Zhu Yiyi

"THE CHINESE JOURNAL OF SOMATIC SCIENCE" has made its appearance. Please allow us to extend our sincerest regards to the readers on behalf of the editorial department.

"THE CHINESE JOURNAL OF SOMATIC SCIENCE" is jointly sponsored by the Chinese Society for Somatic Science and the Shanghai Communications University. The editorial department is located in the Shanghai Communications College Publication House. In addition to the editorial department, we have established a strong editorial committee, and all members of the editorial committee and advisors are well known individuals in the field of somatic science. With the support from this type of editorial committee, we believe the reader can draw his own conclusions about the "prestige" of this magazine.

ON THE NAME OF THE MAGAZINE: "THE CHINESE JOURNAL OF SOMATIC SCIENCE" naturally assume the task of reporting developments in human somatic science. Human somatic science is a scientific discipline which only came of age in the last ten years and especially in the last recent years. Compared to the many other mature scientific disciplines, it is extremely young. Despite this, it has the most vitality of all the scientific disciplines. Through the research over these years, everyone is relatively familiar that human somatic science is a science that studies the human body, this extremely open, complex giant system. It is a branch of science which studies the functional states of the human body in an objective environment (macrocosm and microcosm), and studies the structure and actions of man and his environmental system. Without a doubt, its leading principle is the Thought of Chairman Mao and the philosophy of dialectical materialism as well as the human universal view of Marxism. Its leading scientific theory is a systematic theory which unites the global concept and the reduction theory argument. Its methods are "comprehensive integral methods" combining quantitative and integral methods proposed by Comrade Qian Xuelin in the First Issue of 1990 of "NATURE MAGAZINE" for the study of the complex giant systems.

As for the specific scope of study of somatic science, it can generally be divided into the three aspects of system theories of Qigong (Transcendental meditation), paranormal abilities and Chinese medicine which have historically been excluded from the halls of science. After the entry of Western medicine, Chinese medicine has been viewed as "unscientific". Qigong (transcendental meditation) has been called "superstition". Many Communist Party members have been expelled from the Party for practicing Qigong. Of course, following liberation, Chinese doctors and Chinese Medicine have been called a "treasure", and have been supported. There have been major improvements in their circumstances. Following the "ten years of chaos", Qigong has also been reinstated and its prestige restored, making great strides. However, research

into human paranormal abilities was given a bad name following the Third Plenary Session of the Eleventh Central Committee. As of 1982 there were still some papers lashing out against it on the front pages. Although there have been some changes, to this day it has not yet been set right. Therefore, in the eyes of many people it is connected to "magic and "sorcery." From this the importance of public opinion can be noticed.

It is just because of this circumstance that it has been difficult to publish and circulate publicly THE CHINESE JOURNAL OF SOMATIC SCIENCE. After the first All-China Conference on Human Paranormal Abilities Scientific Discussion was convened in Shanghai in February of 1980, the delegates to the conference had the NATURE MAGAZINE compile and mimeograph the "Human Paranormal Abilities Newsletter" as a way of exchanging information. At the end of that year, the "Human Paranormal Abilities Newsletter begun to be printed by letterpress. In May of 1983 The Chinese Communist Party Propaganda Department agreed and the Shanghai Municipal Party Committee Propaganda Department approved the printing of the magazine RESEARCH IN HUMAN PARANORMAL ABILITIES. However, it was approved for internal distribution only. In May of 1987, the Chinese Society of Somatic Science was established with the approval of the State Science Commission. It was not until April of 1989 that, with the approval of the State Science Commission, an agreement was reached for the formal publication and public distribution of THE CHINESE JOURNAL OF SOMATIC SCIENCE. However, due to a number of technical problems, it was not until May of this year that we officially received a publication permit. In summary, in order that the CHINESE JOURNAL OF SOMATIC SCIENCE could be presented to the readers as early as possible, many comrades have put forth a great deal of effort.

Actually, the earliest proposal for publishing and publicly distributing this periodical was made by Comrade Qian Xuelin. In May of 1986, he made this suggestion to the representatives at the academic discussions of the first session of the Chinese Society of Somatic Sciences. After that, Comrade Qian Xuelin continued to press for publication and performed a great deal of work in this regard. Comrade Qian Xuelin also personally wrote the English Language introduction for this issue. Therefore, Comrade Qian Xuelin not only is an author and reader of this magazine he is actually a publicly recognized academic leader in the realm of somatic science. His keen insight and fine writing has pointed out the direction of research in somatic science. Naturally he has also lead the direction of the publication of this journal.

THE CHINESE JOURNAL OF SOMATIC SCIENCE is an academic magazine. It is primarily targeted at readers who are college graduates. If they feel that major breakthroughs in somatic science research could lead to a new scientific revolution and a second renaissance, then the targeted readership will be even broader. This concerns almost everyone. Therefore, anyone who has an interest in this scientific discipline can become a reader of this magazine.

Since somatic science is a scientific discipline, it is naturally primarily based on scientific experiments. For this reason, this magazine will

primarily publish the reports of experiments. We enthusiastically welcome the comrades engaged in somatic science research to send us a draft of such experiments. On the other hand, science cannot be divorced from theoretical thought, and the developing form of theoretical thought is the hypothesis. Any hypothesis goes through continuous testing, revisions and improvement until it finally becomes theory. Therefore, we also welcome papers expressing the opinions of comrades on somatic science. In the face of such a difficult subject as somatic science, it is easy for people to be reminded of the fable about the blind man rubbing the elephant. He rubs a leg and says it is a column. He rubs its trunk and says it is a hose. He rubs an ear and says it is a fan. He rubs its tail and says it is a whip. Even this is much better than not rubbing it at all and not saying what it is.

This magazine will generally have the following sections: Reports on experiments, hypotheses and exploration, inquiries and controversies, philosophical research, translation of foreign articles, articles by persons with paranormal abilities, book reviews, summaries, personalities, conferences, new books, letters to the editor, and readers guide. Of course new sections will continue to appear in the magazine. Their specific contents will be seen by the reader and I will not waste time talking about it here.

Another mission of this magazine is to carry out exchanges with the rest of the world. Although the scientific discipline of somatic science does not exist outside of China, there are Psi research or Parapsychology research which are close to the same thing. Also ESP and PK share many similarities. Through exchanges with others carrying out the same work, we can broaden our vision and it can give us ideas and even promote somatic research in China. The target of somatic science research is "open", the growth of somatic science itself should be "open" in order to give it vitality. Working in isolation waiting for something to happen is arrogance and conservatism which will result in falling behind - there are too many examples to mention - ranging on the large scale to nations and peoples to the small scale to individual events and persons.

Finally, I want to talk about our philosophy. As editor-in-chief of a magazine such as this, I feel that I am not able to do all the things I would like to. This is not an attempt at humility, I often feel as if I am walking on eggshells. This is because my knowledge and talents as well as experience and abilities do not seem to be enough to tackle such an unprecedentedly difficult scientific question as somatic science. What can I do? There is nothing to be done but to double my efforts and learn as I go. I remember four years ago when Comrade Qian Xuelin personally sent me a note urging us to work hard to study the philosophy of Marxism. The past four years I have not dared to ease up, and through my studies I feel I am a lot stronger. Naturally I still do not dare to compare myself with "experts in Marxism." As for somatic science, I must also conscientiously study and accept new thoughts, new matters, new concepts in order not to continue to elevate myself. In summary, we feel that in this realm, we must first study hard and second we must work hard. We must make more of a contribution, rely on the leaders, rely on the masses, and strive to do a good job with this magazine.

Somatic science is a new scientific discipline. Research is more difficult than anything attempted before. Mastering all of its scientific contents and mysteries will not be accomplished overnight. Starting out from this concept, this magazine is only one record. It is only a printed record faithfully following the journey along the route of somatic science. After several years, turning back to look at what has happened, perhaps our efforts will cause a number of knowledgeable persons to laugh at our efforts. However, we are convinced, that there will be other things we will have done that will pass the test of time and stand up to the test of history, and will light the way to guide those who follow us as they advance. This is also the basic task of THE CHINESE JOURNAL OF SOMATIC SCIENCE and the guiding principle of this magazine.

In summary, THE CHINESE JOURNAL OF SOMATIC SCIENCE is the property of all the researchers in somatic science and all the readers concerned with developments in this scientific discipline. It is our hope that everyone will work hard to break new ground and cultivate the garden that is this magazine, so it will blossom with the flowers of somatic science and may contend among the hundreds of other flowers in the garden of Chinese science, staying always in bloom and never to wither and die.

SOMATIC SCIENCE - IMPORTANT FRONTIERS LEADING TO BREAKTHROUGHS
IN MODERN SCIENCE

THE CHINESE SOCIETY OF SOMATIC SCIENCE

Today, on account of the rapid developments in science and technology, people await even greater breakthroughs in science in technology. Somatic science as a major part of modern science and technology which is just starting to come into its own, may well be one of the most promising frontiers which could lead to this type of major breakthrough.

THE RISE OF SOMATIC SCIENCE IN CHINA

The study of somatic science already has a ten year history in China. This journey has already been strange.

In March of 1979 there was a report in the Sichuan Daily that in Dazu County of Sichuan province a child named Tang Yu had been found that could recognize written characters through use of his ears. This appeared in the strange happenings column of the Chinese Periodical SPRINGTIME OF SCIENCE, immediately leading to widespread interest among scientific workers as well as people from all fields of life. In February of 1980, at the first all-China scientific symposium on such phenomena that convened in Shanghai, there were 14 different people with paranormal abilities attending the conference. Of these 14 persons, 13 were children and one was a adult. They successfully demonstrated their ability to recognize characters through use of their ears in front of all those assembled in the hall.

After that, a number of scientific workers throughout China - most of whom were of a doubting mind - wanted to carry out their own experiments to verify this phenomenon. More and more scientific workers became involved in the exploration and study of these phenomena. A series of new discoveries continued to be made. Province after province discovered a group of persons with paranormal abilities. A large amount of empirical facts were repeatedly demonstrated in a number of places, providing proof of the validity of paranormal abilities and how widespread they were. Researchers in areas all over China continued to discover that many persons with these weird abilities not only recognized characters through strange channels, but could also "see through solid objects", were capable of "telepathy", could conduct "mental telepathy", and could even read "residual information" left on a persons body resulting from past activity. This illustrates that research into human paranormal abilities can bring us into contact with a scientific arena which is rich, unique and is very worthy of research concerning the control, release, transmission, receptivity and processing of information.

After October of 1980, there was another new startling experimental development. Paranormal abilities research teams in Yunnan, Haerbin, Beijing and Anhui separately discovered several even more mystifying phenomenon not only concerning the paranormal recognition of information, but also concerning the process of the act of paranormal abilities. During this period, there were a number of experiments called "psychokinesis" experiments where the subject with paranormal abilities would turn the hands of watches, bend metal, break matches, pluck off twigs, move items and a number of actions which required a definite effort to be done (such as unscrewing, unlocking a lock, and unbuttoning a button) as well as cause exposure of sealed unexposed film, and "spontaneous combustion" of some flammable materials with the wave of a hand, without touching the materials in the experiment. Successes in these experiments followed one after the other. Thus, the occurrence of a series of strange phenomena which science could not explain attracted a large number of scientists from many fields to a new field of scientific exploration attempting to identify and to explain these phenomena. In 1981, at the time the Second all-China scientific symposium on paranormal abilities was convened in Chongqing, there were already hundreds of scientists in this field carrying out many very important observations, experiments and research.

What happened to research into paranormal abilities for a period of time following 1982 is common knowledge. The research in many areas and at many units was forced to stop. Those research activities which continued were carried out under conditions of extreme difficulty. A large number of serious scientists who had entered the arena of paranormal research with an attitude of "doubt" began to look for validity in the experiments with more self-awareness and attempted to establish various types of strict physical conditions in the design of the experiments to ensure the realization of this type of validity. At the present time, a number of scientists are conducting extremely difficult theoretical explorations to search for a scientific explanation to these phenomena.

Almost simultaneous with the discovery of paranormal abilities was a resurgence of "Qigong" (transcendental meditation in China). Especially important in this is the fact that people were no longer just using Qigong as a body building exercise and martial arts training, but a number of scientists, including several who were conducting scientific research into paranormal abilities, also began to conduct scientific research into Qigong. They discovered very quickly that there were a great number of similarities between Qigong and paranormal abilities. Many of the phenomena studied in these two were closely related to the doctrine of energy channels in Chinese medicine and even to the overall theories of Chinese medicine. Some persons of insight began to realize that there might be a very profound inherent connection between paranormal abilities, Qigong and Chinese medicine. If we open our eyes a little more and, on one hand, make full use of modern science and technological knowledge available and methods to conduct experimental and theoretical research of paranormal abilities and Qigong, while on the other hand use the foundation of modern science and technology to fully absorb and

digest the abundant inheritance of Qigong and Chinese medicine over many thousand of years of Chinese history, then it would be possible to tie the research into the three phenomena together. From this it might possible to uncover the secret of the complex giant system of the human body; this most highly developed product of the natural world and of natural evolution. Therefore, as was pointed out by Comrade Qian Xuelin, "Chinese medicine, Qigong and paranormal abilities are all tied together. They form a single complete scientific field." (MAKE FURTHER EXPLORATIONS OF THE PATH TO SOMATIC SCIENCE). "Somatic science must consider at least these three aspects."¹ Thus somatic science was formally born on the Chinese mainland.

In May of 1987, the State Science and Technology Commission approved the establishment of the Chinese Society of Somatic Science. This undoubtedly signifies the social recognition and support of this field of scientific research.

SOMATIC SCIENCE IS A MAJOR PART OF THE SYSTEM OF MODERN SCIENCE AND TECHNOLOGY

What is somatic science?

The target of somatic science research, obviously, is the human body. However, the way somatic science understands the human body, or the angle from which somatic research views the human body is the development of traditional physiology and other sciences to a higher plane. From the viewpoint of somatic science, the human body first of all is a single system, and is an extremely complex system. Its component parts, such as biological molecules and cells come in many types and forms. There are all different types of interrelated functions. At the same time, it is also a large scale system larger than the ordinary large-scale system. We call it a "giant system".

Second, as everyone knows, the human body is a living biological organism. The basic conditions for its existence are that it must maintain interaction with its outside environment and the entire universe. Therefore, this system of the human body is also open. It is one open giant system. Naturally, in the natural world, many organisms are also open complex systems. However, man is different from other organisms. The most important difference is that man has thought, and this type of thought has not been detected in any other organisms. Thought is the highest level of human activity. Thought can have a reaction on the human body. It can have a reaction on the next several levels and even lower levels of activity. Therefore, overall, the human body as the subject of somatic science research, is a complex, open thinking giant system. In other words, somatic

¹ QIAN Xuelin and Chen Xin NATURE MAGAZINE, 11, 5 (1988) 331

science studies and views the human body as a complex, open, thinking giant system.

In order to find out about this complex giant system of the human body, somatic science uses systems scientific methodology. Somatic science uses systems scientific methodology for the most basic description of the giant system of the human body which is the functional state manifested in total at a given time. We call these "functional states." The human body functional state is a quasi-stable one, which is when the corresponding space which the system occupies is correspondingly stable. Even though it is relatively stable, it is not fixed and unchanging. The human body functional state can be regulated, changed from one quasi-stable state to another quasi-stable state. Regulation of the human body functional state can be accomplished through three different channels. The first of these channels is the exchange of matter or energy with the outside such as food, air, or medicine. The second channel is the exchange of information with the outside such as electromagnetic waves, sound waves, etc. The third channel is the thought action produced by the human brain. Thought is the highest stage of action of the human body. It can react on relatively lower levels of action. Therefore, man's own thought is an extremely important method of regulating his own functional state.

Actually, Chinese medicine, Qigong and paranormal abilities all involve special functional states of the human body giant system, and also involve the regulatory process of the human body functions.

Chinese medicine advocates "recognize the state and decide upon a treatment" Here word "state" refers to the functional state and not "symptom" (which is another Chinese character with the same pronunciation). Chinese medicine diagnosis uses the hands to collect and recognize the "host of symptoms". However, it denies input from the eye and goes through "host of symptoms" to grasp and identify the functional state of the patient. The treatments of Chinese medicine generally do not act directly on the seat of the ailment, but regulate the functional state of the patient's body. The use of these treatments or ways of regulating, the abnormal ailment state of the patient is adjusted to a normal healthy state. Because the human body has a certain ability to resist germs, toxins and to eliminate the cause of disease, if the functional state is regulated to a normal healthy state, the disease will disappear.

Qigong and paranormal abilities are both only manifested after the human body enters into a certain special functional state. When masters of Qigong are practicing they must enter quiet, which means they must enter a special functional state - the Qigong functional state. Those with paranormal abilities have to enter a special functional state - the paranormal abilities state. However, in general, Qigong masters have all practiced for long periods of time, so they can enter the Qigong functional state relatively easily and at will. From the viewpoint of systems science, for the Qigong master or the person with paranormal abilities to proceed from an ordinary

normal state to the Qigong functional state, or the paranormal functional state, both cause their body's somatic giant system to leap from a relatively level ordered structure to a type of higher level ordered structure. This has already been observed in experiments. Under the Qigong functional state, the entropy value or the RR interval of the brain and pulse dropped, and the ordered level increased.

Comrade Qian Xuelin has pointed out, "as for the open, complex giant system which is the human body, it is extremely important to study its functional states, to include several human body functional states which have a paranormal nature. As early as the scientific symposium in Chongqing in 1981, he formally pointed out the concept of "somatic functional states".² Now, the use of a persons overall functional state to describe the various functional characteristics of the somatic giant system is not only a type of scientific hypothesis, but an extremely hopeful direction of research which is already supported by scientific facts. Since 1984, a number of comrades at the Space Medicine Engineering Institute used multidimensional data analysis methods to combine the measured changes in the multiple biological indexes into change points that could represent the states of the overall system of the human body to determine the location of each of the variable groups in multidimensional phase space. They have already discovered the target point and target loop of such functional states of the human body as waking, sleep, alertness and Qigong. In this manner, they have found objective observable indexes for somatic functional state research.

Now, we can have a more clear understanding of the concept of "somatic science: the human body is a thinking, open, complex giant scale system. The characteristics of the somatic giant scale system with somatic functional states (including several special somatic functional states). Somatic functional states can switch from one quasi-stable state to another quasi-stable state through material, energy or information exchange with the outside and through thought regulation of the body itself. Somatic science is the study of the functional states of man as a conscious, open giant scale system in an objective environment, the regulation and changes of the functional states. Somatic paranormal abilities, Qigong and Chinese medicine (broadly speaking, it should be termed traditional medicine, and should include the medicine of all the Peoples of China, such as Tibetan medicine and Mongolian medicine) as well as all other phenomena and processes connected to functional states of the somatic giant-scale system should fall within the category of somatic science research.

Somatic science uses the concepts and theories of system science to study the human body and is not in opposition to biological, physiological or modern medicine research, but makes full use of the newest achievements of these sciences. It is guided by the philosophy of Marxism, so all valuable

² Qian Xuelin, NATURE MAGAZINE, 4,7 (1981) 482

knowledge of the human body can be enhanced on the basis of system science and combined to actually achieve a whole concept and reduction concept, and can unify the dialectics of Chinese medicine and of modern medicine. It is just for this very reason that we will be able to scientifically grasp the macroscopic functional states of the somatic system and understand the various microscopic action structure and mechanisms of the various functional states of the human body and thus learn the "what" and "why."

In this manner, somatic science will become a major part of the body of modern science and technology. Comrade Qian Xuelin believes that somatic science should stand among the other eight major disciplines of science - natural science, social science, mathematical science, system science, military science, the science of thought, behavioral science and the theory of literature and art. These nine major scientific fields including somatic science form a complete body of modern science.³

THE SCIENTIFIC FUTURE AND THE PHILOSOPHIC SIGNIFICANCE OF SOMATIC SCIENCE

Does assuming that somatic science is one of the major modern scientific fields is placing somatic science in too high a position? To answer this question it is necessary to properly evaluate and recognize the future of research in somatic science.

As of today there are still many persons who completely deny the scientific nature of somatic science. The most important "evidence" that they present is that the empirical facts on which somatic science is based, especially facts concerning somatic paranormal abilities, seem to be irreconcilable and contradictory with the scientific knowledge which they now have. Therefore, they will not accept and are not even willing to conduct practical experiments to test the existence of these facts.

Here, we are actually touching upon a question of extraordinary importance. This question is: can science only accept and study those facts which are completely compatible with what is already known and fully explained by the available knowledge and which in any way threatens the "foundation" of what is already known? If science is limited to the scope of what is already known in its research of those few "facts", which must ensure that the old knowledge will not be "discarded", what advancements can there be in science? Could there be any revolution in scientific development? If scientific research does not consider "whether or not certain facts actually exists" but only considers "whether or not certain facts should exist" and furthermore use the compatibility of certain facts with what is already known as the basis of determining if those facts should exist, then is practice being used to verify theory or is theory being used to describe the permissible scope of practice?

³ Qian Xuelin, PHILOSOPHY AND RESEARCH, 3 (1982) 19

As everyone knows, a large number of major breakthroughs in science just happened to be preceded by the discovery of "abnormal" empirical facts. The difficulty of theory to explain the energy distribution of black hole radiation and the negative results of the Michaelson - Moeller "ether transfer" experiments were both "abnormal" facts for classical physics prior to the end of the 19th century. If the logic of those who oppose somatic science were to be followed, then men would always be satisfied with the "foundation" of Newton mechanics and would not "cast it off", and there would never have been the quantum theory, quantum mechanics and relativity mechanics. Even more, the philosophy of Marxism long ago reached a scientific conclusion from the theory of knowledge: practice is the only standard for the final test of the truth of theory. The founder of Marxism was very clear on this question, and specifically pointed out: if it is believed that "if anything that will fit into the system of laws and is therefore something we know, is worthy of note; and if it will not fit into the system of laws and is thus something we do not know is not worthy of note, then the things we do not know will all be deemed worthless, and can be ignored. In this way, all science is finished, because science just happens to be the study of things unknown."⁴

Science just happens to be the study of things we do not know. The most important thing in scientific research is to pay attention to the discovery of new empirical facts, especially new empirical facts which contradict old theories. Science continues to advance by continuing to generate and to resolve the contradictions between theory and practice. Actually, modern scientific theory and the modern scientific historical perspective has long ago cast aside that archaic viewpoint that the historical development of science is merely the process of the simple accumulation of knowledge. The development of knowledge has not been limited to the gradually addition of knowledge, but also includes a process of conceptual and theoretical revolution. All scientific theories are based on certain empirical knowledge, framed in the corresponding scientific concepts and the conceptual and logical systems established. When it is possible that additional empirical knowledge continues to be contained within the framework of existing scientific concepts and can still be explained using existing theories, relative stability is maintained in this system of scientific theories. Scientific development is primarily manifested through the expansion of knowledge, increasing the content and perfecting the structure; this is the gradual evolution stage of scientific development. However, once new "abnormal" empirical facts which are no longer compatible with the existing scientific concepts or theories, and cannot be explained using existing knowledge, and these "abnormal" facts have been accumulated to a certain degree, they form a turning point for a scientific revolution -- and a revolution in scientific concepts and theory has arrived.

⁴ Marx and Engles, SELECTIONS FROM MARX AND ENGLES, Volume Five, pp 541

As for whether or not somatic paranormal functions actually exist, the reason many people are doubtful may be because these functions are so far removed from the common knowledge as we have known if for so long, and that it is too difficult to fit them into existing theory. However, the existence of this type of phenomenon has already been verified (the verification of the phenomenon of paranormal functions is not a theoretical question, but is a practical question). These empirical facts form "abnormal" knowledge that can trigger a change in theory, and the rise of somatic science has signalled the coming of a new scientific revolution.

As for revolutions which may occur in modern science, there are a number of discussions on this subject presently underway in foreign countries and in China. Without a doubt, in the progress of modern science, physical sciences have played an extremely major role up to the present day. Life sciences may replace the physical sciences in the next century as the new "leading science". System science is presently expanding its theories and methods into research work in all the scientific fields, providing a way of thinking symbolic of the times for the development of scientific knowledge. It is worth noting that a number of paramount questions which must be resolved by physical science, life sciences, fit perfectly into somatic science research, forming a new area of growth with great promise for breakthroughs.

For example, in the physical sciences the debate of non-determinism in quantum physics began with Einstein and Bohr and has continued for half a century without reaching an answer. In 1980, a Professor at London University, David Bahm, in his paper "Integrality and Hidden Orders" proposed a type of new thesis: that the entire universe is a single system. That all the molecules, atoms and even basic particles of which we are so far aware are nothing more than temporary manifestations within this integral body. In quantum mechanics, the Heisenberg nondeterminate theorem is also a type of surface phenomenon. If we go deeper into levels which our present knowledge is far from reaching, we could discover certain "hidden orders. The December 1983 issue of SCIENTIFIC AMERICAN also published an article which discussed the hypothesis that if quantum mechanics and gravitational field were combined, a basic particle the size of 10^{-13} cm could be much smaller - 10^{-34} cm. At this scale, time would not stop but would pulse. In this way, the "hidden orders" Bahm talks about would appear. His theory is obviously closely connected to system science. From the viewpoint of system theory, the particles we talk about today are actually only "hidden order" self-organized phenomena in this supermicroscopic world. What is especially worthy of note is the connection between somatic science and this theory. Bahm has said himself: "We have not yet completely established this theory. Once it has been established, such paranormal functions as ESP and PK can be explained and will not seem so strange."⁵

⁵ Qian Xuelin, RESEARCH INTO SOMATIC PARANORMAL FUNCTIONS, 3,1-2 (1985)

Also, in biology, the establishment and development of molecular biology has made it possible for us to delve into the molecular level to learn life activities. This is without a doubt a big step forward in science toward the knowledge of the living world. However, the theories and methods that life sciences have used to make this progress are still the basis of achievements in chemistry and biology. As for molecular biology itself, no new scientific concepts or embryonic forms have appeared in molecular biology which would indicate a new era of scientific knowledge. It is only because of the rise of somatic science at present that life sciences has been presented with its greatest challenge. It is especially noteworthy that there have already been experiments which validate the effect of Qigong on large biological molecules, and this has begun to establish a very important connection between somatic science and molecular science - the most exciting field in the life sciences. Somatic science uses the theories and methods of system sciences to study the human body -- the most complex of life forms, as an open, thinking, giant-scale system -- to reveal the macroscopic conditions of the systems it maintains. It also studies the stability of the ordered structures they form as well as the microscopic mechanisms of the system leaping from one stable ordered structure to another ordered structure. It would make possible developments in life sciences that would not only lead to possible breakthroughs in knowledge of life phenomena, but could promote developments in all sciences, changing existing scientific concepts and even the scientific world perspective.

Therefore, there is reason for people to hope that major breakthroughs in modern science will occur in somatic science research. Comrade Qian Xuelin has repeatedly pointed out that "research in somatic science "may lead to a new scientific revolution in the 21st century." It "may also be a greater scientific revolution than those of quantum physics and the theory of relativity in the 20th century." This new scientific revolution will necessarily "lead to a technical revolution which could change the world" and promote a new "cultural renaissance."¹

If somatic science is to complete such a monumental and difficult task, it must undoubtedly "use the philosophy of Marxism - be guided by dialectical materialism. At the same time, the achievements of somatic science research will also deepen and develop the philosophy of Marxism." This is because the problems discussed by somatic science are all closely "connected to the dialectical unification of matter and spirit, objective and subjective, brain knowledge. For such complex questions, "if we do not use the philosophy of Marxism to guide us, we will not be able to avoid errors."¹

¹ QIAN Xuelin and Chen Xin NATURE MAGAZINE, 11, 5 (1988) 331

¹ QIAN Xuelin and Chen Xin NATURE MAGAZINE, 11, 5 (1988) 331

Speaking of the relationship between somatic science and philosophy, it is very easy for people to think back 100 years ago when Engles criticized "materialism." At that time there were a number of scientists who formed "seances" and "occult gatherings" because they were fettered by empiricism. Because they "relied only on empiricism, and were extremely ignorant of thought, they went to extremes in their lack of thought" and even fell into the "extreme fantasy and blind superstition" of mysticism. However, the question is: should those natural phenomena which have been distorted by "idealism" and muddled by various types of quackery be forbidden areas into which science will never step? If this logic were followed, then the ages of ignorance in ancient times before science was even born would still prevail; that is, mankind's knowledge of the entire natural world that "everything had a soul" and "totem worship." Then men would never have had to study further and understand these natural objects and natural phenomena which were worshiped as totems with a spirit. Wouldn't any scientific attempt to study and understand be considered idealism and superstition? We must know that mankind already has a history of many hundreds of years. We do not know how many phenomena (including sunrise and sunset, thunder and lightning and other common natural phenomena) have all been distorted by religious superstition and idealism. If these phenomena were all restricted areas for science, we would forever be unable to overcome superstition. What would we need science for.

Actually, the real task of science is to set right all those facts which have been knocked over by religious superstition and idealism. In order to do this, science should not evade these issues, but must venture into those arenas which have been monopolized by idealistic and religious superstitious phenomena. Only by doing this can science provide a dialectical explanation of these natural phenomena, and not allow them to be considered "supernatural" causes any longer; only then can science take over the areas occupied by religious superstition one at a time, and civilization of mankind can make prosperous strides. If the opposite is done, and the logic mentioned above is followed, the question would be: is science opposing superstition or is it surrendering to superstition in the form of an appeasement. Actually, if it may be said that there is any philosophical significance to the study of somatic science, then its greatest significance lies here: the rise of somatic science is nothing more than a solemn announcement that mankind's knowledge of the open giant-scale system which is his body and its functional states has finally begun to change from the realm of superstition and idealism of the past to the arena of serious scientific study under the guidance of dialectical materialism, and the successes possible here will all become victories of materialism over idealism and victories of the realm of knowledge over the unknown.

THE CONCEPT AND METHODOLOGY OF THE HUMAN BODY AS AN OPEN,
COMPLEX GIANT-SCALE SYSTEM

BY: Chen Xin

Comrade Qian Xuelin believes that in order to do a better job of developing research into somatic science, we must explain that the human body is an open, complex giant-scale system. He said, "Can you ask your hand to write an article? We must stress "comprehensive integration" of the quantitative and qualitative. We must point out that kind of lopsided so-called "scientific methods" are not enough. We must be comprehensive, combining Western medicine, a combination of Western and Chinese medicine, Qigong, paranormal states and all together for our research." I am presently working toward completing that task. I hope this article will be of some purpose for somatic science research and hope even more that others in the same field will provide me with their guidance and instructions.

Up to the present time, mankind has fostered his own intelligence. He has promoted remarkable advances in science and technology and has created uncountable miracles. However, it is regrettable that mankind's understanding and study of himself is still incomplete and not thorough. Although the search for, and comprehension, of life phenomena has reached the molecular level and has made some major advances, it cannot completely understand the complex integral function of the human body. Modern physiology, for example, knows quite a bit about the biological and biochemical changes, and the physical chemistry processes at the cellular level of the brain, but it knows very little about the functions and activities of the brain overall when all these cells are put together to form an integral unit. It is possible to believe that somatic science is a field lagging in modern scientific advancement, but it is also a field with the most vitality.

There are many reasons why this scientific field is lagging behind. One of these reasons is because this field of science studies the human body, and is much more complex than physics, chemistry or electronics. The second reason is because it lacks targeted advanced research technology and methods. The third reason is the most important: this is a field of scientific research that has yet to establish a proper scientific philosophy and methodology. The purpose of this article is to discuss a guiding philosophy and methodology for research in somatic science.

I. THE HUMAN BODY IS AN OPEN, COMPLEX GIANT-SCALE SYSTEM

Many different types of systems exist in the objective world. From different viewpoints, the systems can be divided into different types of categories¹. For example, the natural systems and the man-made systems. The open systems and the closed systems. The active systems and the inert stems.

The life systems and the non-life systems. These methods of categorization are all visual, concentrating on looking at the specific content of the systems. However, it is easy to miss the basic quality of the system. This is an extremely important question in systems research. We believe that the following system of categorization is appropriate. It categorizes systems into simplex systems and giant systems depending on the number of components and subsystems, and the degree of complexity of the relationships between them. Simplex systems refer to those which have few component systems and subsystems, and the relationships between them are relatively simple. If there are a relatively large number of subsystems, as many as dozens or hundreds, then it is a large-scale system. Whether it is a simple system or a large-scale system, to study this type of simple system it is possible to start out from the mutual reactions between the subsystems, and work up to the active function of the composite system. When the number of subsystems is extremely large, numbering in the thousands, hundreds of millions or tens of billions, these systems become giant-scale systems. If the relationships between these extremely large numbers of subsystems is still relatively simple, they are called simple giant-scale systems. The use of direct combination methods to study this type of system is successful. If details are omitted in the function of giant systems composed of hundreds of millions of elements and statistical methods are used to generalize them, it is very successful. This is the monumental achievement of statistical mechanics early in this century. It is the contribution of I Prigogine and Haken.

If there are an extremely large number of different types of systems and there is a layered structure, and the relationship between the systems is very complex and have many different effects on each other, this type of system is called a complex giant-scale system. When there are exchanges between this system and the external environment, it refers to external input and output, therefore it is an open system. This system is an open, complex giant-scale system. No theories or research methods exist for this type of system. There is also no statistical mechanics theory built on the interaction between these subsystems. This question is the key point of discussion of this article, and will be addressed in later sections. This categorization of systems clearly delineates the levels of complexity of systems. It has important significance for research into system science theory and applications.

The human body² has a huge number of subsystems at different levels. It has been calculated that the human body has 3.5×10^{13} individual cells. One cell contains several tens of thousands or even several millions of biological molecules which have to have metabolic systems for survival and functional systems to accomplish the biological functions. Different molecular systems are composed of different cellular systems. Different cellular systems are composed of different organs and physiological systems. Therefore, we may be confident that the entire human body is composed of several hundreds of thousands, millions, hundreds of millions of subsystems of different degrees of complexity, with different functions, and at different levels (physiological and anatomical).

Second, the extreme coordination of its different levels, the detailed regulation control and the high level information procession mechanism systems, allow the human body to be able to carry out completely unified activities. Its subsystems have complexity and uniformity. When these huge numbers of complex subsystems of the human body are conducting overall activities, it is not a simple arithmetic relationship. Between the subsystems, there are complex activities which enhance or slow down, delay or advance, and prioritize and induce. However, they are still unified activities. It is just because they have highly detailed coordinating mechanisms and information processing mechanisms that the activities of the bodies can be unified, and the person can survive and work. For example, the constancy of blood sugar, body temperature, and the internal environment and as well as coordination of mobility all are accomplished through a set of complex biological mechanisms of somatic systems. Such complex coordination and control functions is very difficult to realize in engineering and other systems. It may also be one of the special characteristics which separates it from simple giant-scale systems. Therefore, study of the regulation and control systems mechanisms of the human body could have a major effect on the study of control theory and the automatic control mechanisms.

Third, it has many different types of reaction mechanisms. The relationships between the subsystems of the human body giant-scale system take many different forms. Some are nervous, some are humoral and neurohumoral, and channeling relationships. The different types of subsystems all have their individual type of activities that fulfill their own specific function. As the overall body has required it, the subsystems which form systems have also evolved, such as reaction mechanisms, information transmission, the various movements (conscious and unconscious movements), endocrine, transport, elimination, swallowing, material and energy absorbing and transfer, storage and release, humoral osmosis, blood circulation and overall activity, allowing man to become a comprehensive combination body with many different forms of activity. These multiple type, multiple layer actions are integrated into a single body, and between them there is an interacting mutual coordinating relationship, which is unified in total activities through an extremely complex process.

Fourth, the relationships between the subsystems and the overall body are extremely complex, and the performance of each subsystem can also affect the performance of the overall body, and it is also possible that each subsystem affects the overall body, or affect the overall body by affecting other subsystems. Thus, a human body is an integral unit composed of an extremely large number of subsystems, allowing this system to manifest certain characteristics and functions. Naturally these characteristic manifestation is not that of a single subsystem. From the viewpoint of system functions, this system also is an indivisible integral unit. If the various subsystems are removed, then it will lose its original qualities.

Although the general description provided above of the system which is the human body is incomplete structurally, functionally, behavioral and evolutionary, it is sufficient to explain its complexity and the degree to which it is a giant-scale system. These are the primary characteristics which differentiate it from simple giant-scale systems. Therefore, we have some basis for claiming that the human body is a complex giant-scale system. There are 10^{12} nerve cells in the human brain and an equal number of spongiocytes. The interaction between the nerve cells and between the groups of nerve cells is extremely complex. The human brain can use past information (memory), future information (inference) and information currently being input and the effects of the environment to carry out all sorts of complex reactions to information input.

There is a material, energy and information exchange between the complex giant-scale system of the human body and the surrounding environment, and the universe. It can be stated that man and his environment and the universe form a super giant-scale system.³ The complex giant-scale system of the human body interacts with the world on five levels.⁴

The first level is the investigation of the relationship between man and his world on the level of the universe. This realm has its own basic physical concepts. This is the 100,000 light year yardstick of physics, and the theory of relativity must be used. It may be debated whether there is any relationship between the existence of man and the actual evolution of the universe. The actual nature of the universe is a necessary for the existence of man. If the evolution of the universe did not take this current route, then none of the creatures on the earth, including man, would have been able to appear. The physical parameters of the evolution of the universe and the physical parameters which determine the motion of matter of which we are aware are all necessary for the appearance of man. It may also be said that because man has actually appeared, therefore, the nature of the universe must be so. This illustrates that man is interrelated to the solar system, the Milky Way and the entire universe.

Second is the investigation of the relationship at the level of the macroscopic world. The physics yardstick at this level is 10^2 meters, equal to the size of a football field, and uses the theory of Newton mechanics, thus the investigation of the relationship between man and his environment is at this level (an environment of 10^2 meters). Chinese traditional medicine pays a great deal of attention to macroscopic affects. Modern environmental medicine also is an important part of this. However, it is one-sided, since it only studies the affects of the environment on man and ignores the complex giant-scale system of the human body in relationship with the environment on this macroscopic scale and it lacks system science theories and methods for its research.

Third is the relationship on the level of the microscopic world. This is the investigating of the mutual relationship between man and environment and between man and his universe at the quantum mechanics level. The microscopic

world yardstick is 10^{-10} millimeter and uses quantum mechanics theory. Man's knowledge of the objective world at this scale are the internal nerve cells of man's sense organs and the nerve cells of the brain which process information. Both are quantum mechanics processes on the microscopic scale. This brings the recognition process down to the microscopic level, the quantum mechanics scale, which may be called Quantum Epistemology. On the other hand, the human body can interact with the objective world on his microscopic level which is the quantum mechanics level.

Fourth is the investigation of the interrelationships of man at the submicroscopic level. This level is about the scale of 10^{-34} millimeter.

Fifth is the investigation of relationships with man at the even larger scale above the universe level.

We can see from all this that the human body is not merely a complex giant system, as it also is placed in this super giant-scale system of the universe where it interacts. Therefore, just as Comrade Qian Xuelin from the height of system science fully describes and correctly points out, the human body is an open, complex giant-scale system. Here it should also be pointed out that: (1), A human body by itself is an open, complex giant-scale system. It is also a subsystem of a special complex giant-scale system - the social system. Therefore, the study of this complex giant-scale system can be viewed as the microscopic study of the social system. When treating two or more complex giant-scale systems, the system to be studied should be treated as the primary system and other giant-scale systems should correspondingly be treated as subsystems. At the same time, it is necessary to note their interaction relationships. (2), the human body as a whole is an open, complex giant-scale system. The human brain is also an open, complex giant-scale system. When the human body is overall active, the activities of the human brain and the activities of the other parts of the body cannot be separated. The overall activity is conducted under the uniform coordination of the brain's activity. This situation melds two giant systems into a single body and comprehensively studies the characteristics of the giant system activities of this entity. (3), What we have described, the open, complex giant-scale system of the human body refers to the movement in the material plane, and the human body has spiritual activities. What are the relationships between the giant system movements on the material plane and actions on the spiritual plane. This has already attracted the attention of people of insight around the world. People note that in the modern world, mankind's study of the spiritual plane has advanced more slowly than the study of the material plane. People also realize that if modern science and technology continue to separate spiritual and material aspects and if the modern view of human life continues, a crises for mankind will arise which will require new considerations and evaluations. People must explore the relationships between the spiritual and the material and between the brain and knowledge using scientific methods. Use modern science to rediscover that precious cultural and academic heritage which was lost due to the material developments of recent eras, and restore lost traditions and recent discoveries to establish a new humankind for the future.

We believe that only by using the concepts of dialectical materialism epistemology will enable modern scientific knowledge, social science knowledge, and the thought and spiritual activity generated from interactions between the morals, ideals, beliefs and religions of mankind obtained from the direct or indirect reaction of objective material with the experience of mankind, to actively recognize the objective world and change both the subjective and the objective world. This is the dialectical relationship of the spiritual changing the material and viceversa. This is the major characteristic that makes it different from other giant-scale systems. Therefore, when studying the human body serious attention must be paid to this question.

The concept of the human body as an open, complex giant-scale system is extremely important. (1), It must promote research in somatic science with a new flying leap in leading philosophy and metrology. (2), it must be produce an even clearer, more profound, more thorough understanding of the somatic functions and thus more effectively regulate and improve the somatic functions. (3). It could possibly point out new avenues for materialist scientific research on the brain and knowledge of the spiritual and the material.

II. A DESCRIPTION OF THE CHARACTERISTICS OF THE OPEN, COMPLEX GIANT-SCALE SYSTEM OF THE HUMAN BODY

Over the last 20 years, giant-scale system theory and systems research has already passed through the stage of ordinary systems theory and has come far from the thermodynamics theory stage of thermodynamic balanced dissipation structures and entered the stage of statistical mechanics and coordination. This work demonstrates that complex giant-scale systems can contain many relatively stable functional states⁹. Every degree of freedom in the phase space of a giant-scale system occupies certain coordinates. In this multiple element phased space of the billions of degrees of freedom, the system has points or loops of relative stability, and the system can stop near these points or loops, forming a system functional state. A complex giant-scale system has more than one point or loop, and can, through internal or external effects, enter one point or functional state to another point or functional state. The human body is an open, complex giant-scale system, and it can have functional state coordinates to describe its characteristics and a person's overall functional state. It is a quasi-stable state, it can be regulated. It can be switched from one quasi-stable state to another quasi-stable state. There are many functional states of the human body which are especially important with clear unique characteristics. These often appear in common activities and work. We call these the human body functional state or somatic functional states. We borrow a term from quantum mechanics called the Eigen state. It primarily represents the states of normal waking and normal sleep. All of the human body functional states are quasi-stable states; they can be regulated. The methods of regulation are: first method is the material exchange with the outside world such as medicine, drink or food, breathing air, etc. The scope of materials exchanged is extremely broad. The second method

is information exchange. The information from the outside world can be sound waves or electromagnetic waves. Naturally they are in a complex form. The third method is the thought generated by the human brain. Thought is the highest level of activity of the human body. It can react back on lower levels, and is a major method of regulating the functional states of the human body.

To use the overall functional states to describe the characteristics of the various functional states of the complex giant-scale system which is the human body is no longer just a hypothesis, but is a fact which has already been proven scientifically⁶. Since 1984, professor Yu Hefeng and others of the Space Medicine Engineering Institute have conducted exploratory research on the functional states of the human body. They use multiple dimensional mathematical analytical methods to take the changes in physiological indexes they have measured and combine them into system changing points which can represent the entire body. At each location of multiple dimensional phased space formed by their various changes, the activities reached relative stability at the locations of the target points and target loops.

Recently, associate professor Song Kongzhi of the Space Medicine Engineering Institute used EEG indexes to describe the functional states of the complex giant-scale system of the brain. His experiment was to record the EEG of persons with paranormal abilities and with Qigong abilities, and use various methods to analyze hundreds of brain graphs and different frequency spectrums, selecting significant indexes with large volumes of information such as brain electrical energy, frequency information and structure information combined into an ordered parameter (X) and found its derivative (X') and compiled graphs of the phase planes. From the phase locus it was possible to see the activities at the locations of the target points and target loops had reached relative stability during paranormal function states and Qigong states.

The use of giant-scale system functional states to describe the open, complex giant-scale system of the human body or the human brain gives scientific basis and objective indexes for somatic science research. It is of important significance. This work has just begun. It is a good attempt, demonstrating that the human body and the human brain are open, complex giant-scale systems which may possibly be described by using functional states. It is still necessary to use multiple indexes to quantitatively and qualitatively combine human senses, knowledge and thought for comprehensive analysis. This type of work is very difficult, but is of important significance. It can describe the functional states of the human body or the human brain more accurately.

Because modern medicine has not studied the human body as an open, complex giant-scale system, it naturally has not used the functional state to describe a certain functional state. However, the various physiological and pathological states do exist. Naturally, the study and knowledge of these states is incomplete, and overall quantitative descriptions are lacking.

Therefore, if all the states in modern medicine were described as functional states new problems would be discovered, and progress would be made.

In modern physiology and pathologic physiology there is a famous Selye stress theory. This was a major contribution to medical science. In 1936, Selye first came out with his theory on stress, aggregate diseases of the overall reaction to stress and adaptational diseases. This theory incorporated the laws of the advent and progression of the diseases. The meaning of stress is the sum total of nonspecific common reactions of the body to different stimuli and pressure. Selye believed that the body reacted in two ways to the various internal stimuli and stressors: the first way was to generate a corresponding specific reaction depending on the stressor. At the same time, the other way was that the body would always generate corresponding nonspecific reactions no matter what the stressor - this is called stress. The purpose of stress reaction is to maintain life and to restore function. The overall stress disorder is a common manifestation of the reaction to stress. Reactionary disorders refer to disorders caused by poor reactions or a breakdown of the reaction mechanism. Selye discovered that during stress reactions, there was an increase in the adrenal gland, with an accompanying histological hyperfunction, atrophy of brain lymph tissue, and changes in the blood hemogram in that area (reduction of blood cells, reduction of lymph cells, increase in polymorphonuclear cells) and intestinal ulcers. Overall stress disorder progresses in three stages. (1), The arousal stage. At this stage there is still no reaction. (2), The resistance stage. At this stage the reaction has reached its maximum degree. (3), The degeneration stage. During this stage, the reaction is lost. Selye's theory is recognized throughout the world. The process of the reaction of the body's resistance adaption to the stressor is actually the complex giant-scale system of the body adjusting from a normal functional state to a functional state of resistance to adaptation disorder. We also note that the switch in functional states is a process broken down into three stages with different functional characteristics. If we can study this using the theoretical methods of the functional states of complex giant-scale systems, we would discover many important patterns which would play an even greater role. We can analyze the giant-scale system structure of the complex giant-scale system of the human body during the process of reacting to a certain stressor; the inter-relationship between the subsystems participating; changes on the different microscopic and macroscopic levels; the characteristics of the functions and the regulating mechanism; all would be more complete and reasonable, deepening our understanding of the characteristics of overall activities of the human body giant-scale system. In Western medicine and physiology it has been discovered there are many different functional states: there is the waking functional state, the sleep functional state, the alert functional state, and the adaptive functional states which the mechanism enters under unique conditions in order to survive - such as lack of oxygen and shock. Their characteristics are that they all carry out their adaptive function through systems formed by the body's adaptive mechanisms. Once the adaptive capability is surpassed then a new pathological state is entered. This is the process of switching from a physiological functional state to a pathological functional

state. When switching from one functional state to another functional state, there are three characteristics which be noted. The first characteristic is the functional state process which is divided into several stages and the quasi-stable functional state finally reached. The second characteristic is that because the internal and external factors have different effects, the structure of the complex giant-scale system of the human body, that is the structure of the subsystems, is also different, and there are subsystems causing the major effects comprising the giant-scale system, so naturally the functional states are also different. Therefore, when studying somatic functional states, it is necessary to grasp the major components of the subsystems comprising the giant-scale system. It is necessary to use the theories and basis of physiology, so naturally it is best to cooperate with those working in physiology and medicine. Third is when there are changes in the functional states of the human body, the functions at the microscopic level will also change. This is also a fact which must be considered when doing research into somatic functional states.

Chinese medicine takes note of such environmental factors as climate and geography and makes a composite analysis of the entire body for diagnosing disorders. This is an important theory of Chinese medicine. It is appropriate. However, we believe that from the viewpoint of somatic science, we should use the theories and methods of an open, complex giant-scale system to study Chinese medicine, and to propel Chinese medicine into the road of modern science.

The "symptoms" of Chinese medicine are somatic functional states.⁸ The terms in Chinese medicine do not refer to certain parts of the human body structure but refer to the manifestation of certain functions in the human body giant-scale system. These are macroscopic parameters, not microscopic parameters. The macroscopic parameters of the atmosphere are air pressure, temperature, and entropy. The microscopic parameters of the atmosphere are the nitrogen molecules and the oxygen molecules; these are quantity and momentum. When a certain cellular tissue is damaged and causes a pathological reaction to an organ system, it is called such and such a disease such as heart disease or kidney disease. I feel that this is microscopic parameters or partial parameters of the organ systems, and the overall body reactions this leads to: fever, exhaustion, lack of energy and lowered resistance are the macroscopic parameters. The human body is an integral body. It is a complex giant-scale system. If certain cells or organ systems under go a pathological change, it will necessarily have an effect on other organ systems, leading the compensatory or adaptive reactions in the somatic functions. This is just like the balance and imbalance of the YIN and YANG elements and the order or lack of order in the five internal organs which is manifest on the surface or internally, by hot and cold, or empty or full and such changes in dominance in YIN and YANG. This allows us to look at the macroscopic parameters of the various symptoms and body signs at different levels in the entire body. The "symptom" in Chinese medicine includes signs of disease: symptoms and body signs; causes of disease: six excesses and seven emotions; location of the disorder: whether the ailment is surface or internal; what organs are

involved; the nature of the disease; hot or cold, positive or negative, surface or internal, YIN or YANG, and the trend and prognosis are all recognized as patterns of disease. It is only in this way that it is possible to have some basis for the treatment of the disease. In this way we can use the theories and methods of the giant-scale system of the human body to bridge the gaps between Chinese and Western medicine. Western medicine uses microscopic changes in the cellular tissue and organs to study the overall reaction to treat the disease. Chinese medicine uses the macroscopic reaction of the overall reaction to study the microscopic changes to treat the disease. The two stress different aspects. They each have their good points and their shortcomings. Western medicine stresses the diagnosis of the cause of the disease as extremely important. It believes that once the cause is found, the disease can be cured, but it ignores the improving of the overall functioning of the body and the resistance to disease. Chinese medicine, on the other hand, stresses the overall body and neglects the diagnosis of the cause of the disease. The two should be dialectically combined, handling different situations differently. As for the terminology and techniques used in Chinese medicine, this is not a real problem. If the contents were made uniform, the terminology could be the same and advancements would naturally be made in methods. The theories of giant-system functional states combines the microscopic and macroscopic changes at different levels into a manifestation of characteristics of the somatic functional state. It is an important theory for uniting Chinese and Western medicines. The description of somatic functional states should include the various levels of the human body, the microscopic and the macroscopic characteristics, and should also include the emotions and conscious state as well as the surrounding environment in observing the changes in the somatic giant-scale system to form somatic functional states. Deep-going research into the theory of functional states can quantify, make more scientific, and modernize the diagnostic process. It can not only accurately diagnose illness, it can also dialectically and dynamically grasp the control parameters of the functional state to treat illness. It can also demonstrate the design of a treatment plan, evaluating and predicting results. This can elevate present day medicine treatment levels to the pinnacle of modern science.

The combination of Chinese and Western medicines has achieved a certain amount of success in China. This is simply from one making up for the shortcomings of the other. The macroscopic diagnosis of illness in Chinese medicine requires the basis of a microscopic mechanism. The Western medicine diagnosis requires the overall treatment of the disease of Chinese medicine. Generally speaking, the attitude toward Chinese medicine is that portion which is compatible with the theories of Western medicine is acceptable, or that it is acceptable to use Chinese medicine to treat patients. Neither of these methods are able to make any new basic advances in medicine. They will lead to any breakthrough. We believe we should use the theories and techniques of modern science to recognize the normal and pathological patterns of the human body and medical treatment, and thus come up with new medical science. It is only in this way that Chinese and Western medicine can be developed along the proper path, obeying the laws of scientific advancement. The validation that

the human body is an open, complex giant-scale system and the use of the theory of somatic functional states are important stages in the renewed total recognition of somatic functions, and they will play a role in promoting the advancement of medical science.

As for so-called balanced medicine, or treatments to lead to a balanced state may well be the somatic functional state regulation or switching effect, so the body undergoes a series of adaptation and resistance steps after invaded or interfered with by internal or external factors, reorganizing the giant-scale system's mechanisms so they have new functions, so the body will switch from a normal functioning state. This so-called restoring the body to a normal balanced state, is actually switching from a normal state to a new functioning state to adapt to the present situation and is not returning to the functional state at the original level.

The Qigong functional state⁹ : By combining the theory of an open, complex giant-scale system and a great deal of experience we can see that the human body can switch from the normal functional state of consciousness to the Qigong state or the Qigong functional state through a variety of techniques. This state is a quasi-stable state. The acknowledgement of the Qigong state includes Qigong into the framework of modern science. This has major significance for the study of Qigong. On the other hand it may be the site of a breakthrough in the study of somatic science. The various techniques of Qigong are steps or methods which may cause a person to enter the functional state of Qigong. There are many techniques, and it is difficult to combine them into one. There are several possibilities for this. One is, are all Qigong states the same? If they are not the same, then which technique will allow entry to what Qigong state? Another is that although there are many different techniques, but do they all eventually enter the same Qigong state? Also there need to be a scientific objective standard for entry to the Qigong functional state. Therefore, the use of Qigong theories and methods to study the control parameters of the Qigong state, and the characteristics of changes of the Qigong state are really leading study of Qigong onto the road of science. In this way, it is also possible to unify all the separate different techniques, and the Qigong characteristics will be easier to be described by objective indicators. What special Qigong has what special function will also be easier to study. Comrade Qian Xuelin also pointed out that Qigong scientific research must start out from phenomenological Qigong studies, setting up phenomenological Qigong studies. This is the first step in the study of Qigong, and it is a necessary step. Phenomenological knowledge is prescientific in nature, but is one step more advanced than empirical knowledge. It is the knowing what happens, but not knowing why it happens. Once we know why it happens, it becomes a modern science in the body of modern sciences. The first step in phenomenological study of Qigong is to qualify and quantify the data on Qigong practitioners and the materials used both objectively and subjectively to establish system models and to describe the Qigong functional state. One step at a time will discover the phenomena of entering the Qigong state, the characteristics of the Qigong state, the

functions of the Qigong state, in order to establish phenomenological Qigong studies, and to search for the mechanism on this basis.

The paranormal functional state¹⁰: In certain states, people can do many things that normal people cannot do such as recognizing characters without the use of sight, moving objects without touching them, removing objects from sealed containers, and putting torn paper back to its original condition. We believe that the human body, this complex giant-scale system open to the universe's super giant-scale system can only manifest this paranormal ability when in a paranormal functioning state. This type of theory places research into paranormal abilities on the basis of the philosophy of dialectical materialism. It specifically falls within the framework of advanced systems science. The study of the patterns of this type of complex strange phenomena can, on this basis, gradually delve into the exploration of its mechanism, avoid taking wrong turns, and falling into the avenue of idealism or mechanical idealism. The use of the theories and methodologies of systems science may allow for more complete study of the various phenomena of paranormal abilities and for the establishment of phenomenological theories to lay the scientific basis for the study of its mechanism. Study paranormal abilities using the theories and methods of functional states, to find the pattern of entering paranormal functional states from a normal functioning state. In order to grasp the control parameters. In this way, mankind may be able control the entry into the so-called paranormal functional state at will. Then there will be a revolutionary change in the capabilities and methods of human activities, with consequences impossible to predict. We feel that the theories and methods of functional states are major changes in the study of human science. The use of these concepts and methods to study the ordinary states of the human body and the paranormal states must result in new contents for human sciences. We should first start by studying the ordinary states of the human body. This is because the most data exists on the ordinary states which can be used for systems research, and at the same time, it is easy to control the body conditions when the body is in an ordinary state, so it is easier to come up with studies of the human body under ordinary states. Use composite integrated methods which are a combination of quantitative and qualitative methods to refine ordinary somatology from the great numbers of various medical programs of Chinese medicine and Western program and normal physiological materials. We can then use ordinary somatic functional states to observe somatic paranormal states, discovering the location of the paranormalities. This is the beginning of the study of somatic paranormal states.

To summarize, the functional states of the complex giant-scale system of the human body are the central task of the study of somatic science¹¹:

(1). Study the patterns and mechanisms of the various functional states of the human body. The functional states of the giant-scale system of the human body have relative stability but they are not forever unchanging, but are constantly changing. They are a state of relative stability. This is the functional state of the human body. Otherwise they could not be called somatic functional states. The so-called stability refers to not changing and has a

certain degree of resistance to interference. Or that is to say when there is interference which causes the giant-scale system to leave its stable state, it can rely on certain functions to return to a stable state. Therefore, the functional states of the giant-scale system of the human body, under certain effects, can switch from one functional state to another type of functional state. The switching process has characteristics which run from gradual change to sudden switching. Every somatic functional state can be described by using state variable space. Also, the stable states of this system must be located at the bottom of a certain place on this potential function. The state variables of the somatic functional states should be macroscopic and microscopic biological and biochemical changes, changes in psychological consciousness and changes in the surrounding environment. When selecting these variables, they should be refined by using mathematical methods so the indexes can represent the characteristics of the functional state to be used to study the mechanisms of the somatic functional states.

(2). Study the differences in the various functional states and deeply recognize the characteristics of the various functional states and their biological and medical significance. First we should begin with the study of ordinary functional state, and after the patterns are found here, then it will be possible to use these to compare with paranormal functional states to detect their special characteristics, which is what makes them special.

(3). Study the switching process of the various functional states. Explore and study the control parameters of switching somatic functional states. As science and technology continue to advance, there will be more and more methods to use to affect the switching of functional states. However, how are we to focus on one certain special functional state to select suitable control mechanism, or to select the input window of switching the functional states. In recent years many different types of treatment devices have appeared, some of which have obvious effects and some have no effect. It may be said that none has been able to alter the somatic pathological function from the viewpoint of the control parameters, and none has looked for the input "windows" for deep-going research, so they have been blind. LEINEI [phonetic] and TUOMU [phonetic] in their catastrophe theory point out¹² changes in the natural world - when there are four or less than four control parameters - are of seven basic forms. They are: overlapping form, pointed form, dovetail form, butterfly form, double curve form, oval and elliptical forms. When the number of control parameters is extended to five, there are many different change models. This theory reminds us that when we are studying changes in the somatic functional state, we should look for the control parameters and their relationship to the change in the type of functional state. If we use the various therapeutic methods, drugs, and treatment means as control parameters, then we need to study the quantitative, qualitative and pathological change effected. This type of theory deepens the study into somatic science and expands the biological and medical contents.

(4). Study the physical, chemical, biological and somatic reactions generated by the various functional states. Somatic science research has

discovered that when the human body is in a certain functional state, it generates various effects (physical, chemical, biological and somatic effects). These are questions unaddressed by classical biological research such as when a Qigong master enters the Qigong state, air is given off, how is it generated, how is it released, what is it made of, what is its function, all of these are important topics for somatic functional state research.

The significance of somatic functional states is wide ranging. It macroscopically and microscopically unifies man and the five layers, expanded, universal, macroscopic, microscopic and submicroscopic within the human body. It deepens and expands the knowledge of the giant-scale system of the human body. It places research in Western medicine, Chinese medicine and the Qigong paranormal functions at the frontier of modern science, and it may become the area of breakthroughs in modern science. It will be able to connect the contradictions between the various theories in Chinese and Western medicine and connect and perfect theory and practice in Western and Chinese medicine, developing a new medical science for the benefit of mankind.

III: THE METHODOLOGY OF SOMATIC SCIENCE

It is impossible to resolve the contents of somatic science research within the framework of modern science. The breakthroughs in somatic science may lead to a new scientific revolution. The history of science reveals that any major scientific revolution in the history of man will lead to major changes and developments in methodology.

Just as we have described above, the human body is an open, complex giant-scale system and is located within the environs of the super giant-scale system of the universe. Therefore, when doing research in somatic science, we cannot study the human body independently, but must investigate the system changes in the super giant-scale system at the five layers formed by man and the universe. Not only must we explore the somatic fields, we must also investigate the fields of the universe. Not only must we investigate the traditional means of energy and information transfer, but we must make special efforts to research the possibility of common bonds between man and the four layers of the universe as well as the effects of different depths of bonds and different layers on the macroscopic and microscopic states, functions and behavior of the integral system of man and the universe. Therefore, when conducting somatic science experiments, all types of physical and dynamic parameters in the universal environment are to be recorded.

When conducting somatic experiments, we should also pay attention to the interactions among the human body - the environment - and the object being tested. The three should be studied as a single system. The experiments of professor Lu Zuming can enlighten us on these questions. Several researchers, when using physical testing methods to study the external air of Qigong, detected a fluctuation in infrared radiation. Therefore, they believed that the external air was low frequency fluctuations regulating infrared radiation. The subsonic sound was believed to be the external air containing infrared radiation and subsonic sound. Strictly speaking, it can only be said that when the external air acts on the infrared detector, the detector generates subsonic sound, and the infrared and subsonic sound is not necessarily the external air. In their first experiment they encased a test tube of ethyl bromide solution in a double kraft paper envelope. After the Qigong master had directed his efforts on this envelope for five to ten minutes, the envelope was opened. They discovered that the solution had faded in color. What caused the solution to fade? Was it that infrared rays had penetrated the kraft paper envelope or was it that it had been heated to over 250 degrees Celsius? Naturally, neither of these was possible. Another of their experiments used a lithium chloride thermal light releasing detector to test the Qigong area. They detected an effect like neutrons. Everyone knows that to radiate an infrared ray, it only requires the energy of one electron-volt. However, for a neutron to be released, it has to break away from the nucleus of the atom, and this requires more than a million electron-volts of energy. How could Qigong generate this much energy? How could this phenomenon be explained? It could be that the external air coming in contact with the universe environment or with the target object generated infrared rays, gamma rays or neutrons. This experiment inspires us to consider the interaction between the human body and the environment (the five levels of the universe) and the target object and the effects generated by such interaction when we conduct somatic experiments.

Another major factor when conducting somatic science experiments is that we must pay attention to the effect of consciousness, that is, we must consider the effect of the tester, and even more so, consider the state of consciousness of the subject. At the same time, we must also consider the state of consciousness of the one inserted into the overall man-universe-object system. Experiments should take note of the state of health, emotional state and state of consciousness of the subject. They should also take note of the tester's mental activities, what is he thinking, especially mental activities that could affect the success or failure of the experiment. All of these should be described and recorded. Man has mental activities. This is the primary basis for the difference between somatic science and life sciences. This is one of the major contents for study in somatic science.

Faced with this open, complex giant-scale system - the human body as the subject of study, there must be some new changes in the research methods in somatic science in order to have an overall knowledge of the human knowledge, find patterns of activity and their mechanisms. We need a new methodology, methods and technical tools. This is very important.

Life sciences research which includes the human body has always used the methods of reduction theory. The reduction theory believes that all complex activities can be reduced by stages to simple activities. The overall activity can be reduced in stages to the actions of the single constituent elements. For example, the biological activities of the human body can be analyzed by stages to structure of activities of the system, organ, tissue, cells, subcellular tissue to the biological molecules and determine the activity function of the entire human body. Then further analyze the characteristic states and behaviors of the genes, atoms, and chains of the molecular structure and function, and these will be determined by the actions of the basic particles of which they are comprised. This sums up all the biological activities of the human body as the functional activities of its most basic elements. The methods of the reduction theory has played an important role in the development of life sciences. It has launched research into genetic codes, biochemistry and biophysics with huge successes which are already being applied in biological engineering, which has made important contributions to mankind. However, the reduction theory still cannot explain the overall functions, still cannot uncover the laws governing the overall activity of the human body. We believe that we should apply the reduction theory from the viewpoint of the integral theory, and on the basis of the reduction theory, perfect the integral theory. This is the study of macroscopic phenomena on a microscopic basis, and deepen the study of microscopic content to research macroscopic phenomena. Stated simply, it is the use of the system theory which dialectically unifies the reduction theory and the integral theory to study somatic functions.¹³

In the past thirty years, because of the advancements of the control theory and the information theory, and their gradual applications in research in the human body, comprehensive methods have begun to be used.¹⁴ Analysis of somatic functions have begun, models of functional activities at the cellular, organ, and system level have been analyzed and applied, which have played a definite role and has been an advancement in biological research methods. However, this method only recognizes a few partial patterns, and cannot recognize activity patterns of the entire body.

In the past twenty years, the dissipation structure advanced in thermodynamics and the synergetics advanced in statistical mechanics have deepened and improved the major ideas and theories in system science. Synergetics is the study of all ordered fixed structural forms and the self-organization process in the movement and development of matter. The use of the principles and methods of dissipation structures and synergetics to process open, simplex giant-scale systems has been successful, solving a number of major problems. Therefore, in the past several years there have been some people who have used the theories and methods of synergetics to conduct research on the functions of partial system organs in the human body, and it seems that this is a step forward. We believe that this can strictly control conditions, and reasonably simplify the characteristics of the activities of the systems of a giant-scale system, allowing the certain organ or system of the human body being studied to approximate a simple giant-scale system, and

then using this theory and method to process and have a clear knowledge of the corresponding realities of the results. This type of methodology may also be considered an advancement for somatic science. However, if we are determined to use these methods of processing simple giant-systems to process an open, complex giant-scale system - the human body, the results will not be successful. This is because this theoretical method is restricted and has applicable limits, and cannot be copied mechanically in disregard of specific conditions.

In addition, there have also been some people who promptly elevated the complex giant-scale system to philosophical heights, saying without any basis that the activities of a system are determined by the subsystems, that the macroscopic is determined by the microscopic, and so on. Some people, without noting that we do not yet have a complete knowledge and grasp of subsystems, insist on the "theory of universal holistic unity, a part contains all information concerning the whole", and "the part is the whole, and the whole is the part, the two are absolutely one and the same," thus using incomplete knowledge to theorize about what they do not know. Such biased so-called scientific methods cannot be successful.

The only method that can currently be used to process an open, complex giant-scale system is that which has been refined, generalized and abstracted on the basis of actual practice by the Chinese system science workers under the guidance of Comrade Qian Xuelin. This is the comprehensive integrated method which combines qualitative and quantitative methods. This method takes the knowledge and experience (usually qualitative) gleaned by all the specialists concerning systems, available data and scientific theory to calculate the mathematical model of the many parameters of a giant-scale system and to repeatedly compare the results with the final theories formed. This type of conclusion is the best possible conclusion at our current stage of knowledge of objective matters, it elevates quantitative knowledge to the level of qualitative knowledge.

The study of the structure of the open, complex giant-scale system of the human body, its functions and behavior, and the patterns of the various control factors for switching between the various functional states must use the composite integrated method which combines qualitative and quantitative methods. This is another major advancement in the path of advancement of somatic science.

Now we will discuss necessary conditions to use this method to study the overall functional state of the open, complex giant-scale system of the human body.

First, collect and store the parameters of the human body while it is in various functional states, to include parameters of the normal states and pathological states, macroscopic and microscopic parameters, and parameters of biological and biochemical changes. For example, the blood pressure, urine and stool parameters of the normal state and the change in parameters for the

different pathological states. Collect these somatic parameters required for the advancement modern scientific to set up data banks for somatic medicine (Chinese and Western medicine) and clinical medicine.

Second, collect parameters on the changes resulting from the physical and ecological environment in which man exists; such parameters as how high temperatures lead to increased pulse rate and perspiration should all be collected and stored, to set up an environmental medicine data bank.

Third, compile specialty systems for scientific theories and empirical knowledge of each of the specialties such as basal and clinical Chinese medicine and Western medicine. This is especially important for the question of application of the empirical knowledge of the various specialties. Actually, this is important knowledge engineering, and is an expression of empirical knowledge and knowledge processing. It is a reasonable way to organize and utilize knowledge engineering. Work in this area is still far removed from actual use, and requires a great deal of effort by specialists. At the present time, this empirical knowledge still cannot be computerized.

Fourth, measure the somatic parameters and the physical parameters of the human body - environment - target object systems during experiments on the different functional states of the human body to collect a great deal of parameters and data. At the present time, many changes of the human body still cannot be measured, and non-destructive measurement of microscopic changes is very difficult. With advancements in technology, we believe that there will be relatively rapid developments in this area. Also, when doing research in somatic science, it is necessary to introduce the parameters of the effect of consciousness. This is very important, but it is also very difficult. At the present time, there is still no objective which can be used to express the consciousness parameters. It is only possible to study the description of subjective feelings. When these basic conditions are met, it will be possible for the open, complex giant-scale system of the human body to be comprehensively analyzed according to this method, and the results repeatedly discussed with specialists in Chinese and Western Medicine, environmental specialists, specialists in physics, and other related specialists as well as those with paranormal abilities and Qigong masters to finally be able to determine the functional states of the human body. This method can be used to study the characteristics of the structure, function and behavior of the open, complex giant-scale system of the human body, grasp the various factors that affect the functional states, uncover the laws governing the switching of the functional states. Viewing the developments of the methodology of science historically, in the 17th century during the renaissance, modern scientific methodology was born, beginning with Galileo to Newton. All subjective elements were discarded and science was founded entirely on experiments. It was believed that this was the only scientific method. However, we have run up against major difficulties, for example, it does not work for the study of human thought. Because the study of thought must rely on mans subjective thinking and reflections, and it is impossible to use the scientific methods to study thought. Newton's is a quantitative method, and subjective thinking and

reflective methods are qualitative methods. In the materialistic society, scientists do not use the methods of the ideas of dialectical materialism, and have placed subjective considerations and reflection on the same level as idealism. Leading the modern scientific metrology in the direction of mechanical materialism, dismissing the role of the subject, forming methods of the reduction theory, cannot observe or conduct experiments on complex problems. Actually, human knowledge of the world is a result of an interaction between both the subjective and the objective. Under the guidance of Comrade Qian Xuelin, workers in China's systems sciences have come up with the comprehensive integration method, which is a combination of the objective and the subjective, for studying the open, complex giant-scale system of the human body, and have demonstrated its effectiveness. The beginning point for answering a question is from a qualitative, confused, restricted perceptual knowledge. A model is compiled using different peoples' different feelings at different times under different times. This model is very complex, and it must be able to determine hundreds of different parameters. It is not just a name used by specialists, but is used to calculate data. It is also used to combine qualitative perceptual knowledge and actually measured data a little bit at a time, and expressing this through the model. This elevation from qualitative to quantitative, from perceptual to the rational is true dialectical materialism. First, it is material, second it is dialectical. This method uses such modern science and technology as computers, artificial knowledge, and knowledge engineering to actually resolve the questions of open, complex giant-scale systems, which are the human body giant-scale system, the geographic giant-scale system, the environmental giant-scale system, and the social giant-scale system. This method will play a major role in the next cultural renaissance. This is another major contribution of China's system science workers.

The overall functional activities of the human body, including the activities of the human brain, is a physical open, complex giant-scale system. It also involves the brain and consciousness, spirit and material, subjective and objective areas of research. The comprehensive integrative method which combines the quantitative and the qualitative is currently the best method for studying this open, complex giant-scale system. It is used to understand the human body with objective and subjective interactions. It can combine unspecific perceptual quantitative knowledge and various data measured by instruments for analysis, so there can be a complete knowledge of the characteristics displayed by the activity patterns of the somatic normal states and pathological states. Actually, modern medicine can determine a great deal of data. Although it is far from enough, methods of performing comprehensive analysis of that data already determined are even more lacking, and large amounts of perceptual empirical data have not been compiled and have not been subjected to comprehensive analysis by modern scientific and technological models. When a doctor is performing diagnosis and treatment in a modern hospital, he must conduct a great many objective physical and chemical examinations. He must learn the patient's primary complaints, and must obtain large amounts of data and information, and then the doctor will perform comprehensive analysis of this material to make his diagnosis and apply

treatment in accordance with the disorder. This is seen all the time. Doctors believe that this is very scientific, and if anyone said that not enough comprehensive analysis was conducted, the doctors would find this difficult to accept. Why, then, is there an admitted difference between clinical specialists and ordinary doctors? What is the difference? The primary difference is that the experienced clinical specialist has had a great deal of practice and has accumulated a great deal of diagnostic and treatment experience. He can very naturally combine this medical case experience with his examination data to perform comprehensive analysis and to discover the primary contradictions, the secondary contradictions of the human body when it is sick, as well as the interrelationships between these contradictions and patterns of changing conditions. In this manner he is able to grasp the patterns of diagnosing ailments. This is the first point. The second point is that for the experienced clinical specialist in order to elevate unclear qualitative empirical data to the quantitative level must use a computer to process the data. This point is also conceded. The third point is that he first determines the data which can represent the normal and pathological functional states of the human body. These are not unspecific, but can be measured. They are not blind, but are targeted data. The fourth point is to establish a complex medical case model combining the theories of Chinese and Western medicine and the practical experience of doctors, and to use advanced techniques such as large computers to carry out comprehensive scientific analysis. The use of these methods of examination and measurement, then it will be possible to immediately complete such medical treatment programs and measures as diagnostic, treatment and prognosis. This will necessarily play an important role in the advancement of health. It will not only be able to locate the clues to normal functional states and pathological functional states of ordinary people, will also be able to find the clues to the functional states of Qigong masters and persons with paranormal abilities. From this viewpoint, the diagnostic and treatment methods and procedures of modern hospitals are still not modernized enough. The comprehensive integration methods of combining the quantitative with the qualitative are important measures in promoting modern medicine. They are an important content of somatic science research. We can foresee that developments in medicine in the 21st century should be medicine with somatic science concepts and methods.

IV: CONCLUSION

In conclusion of this article, we once point out that somatic science is the study of the open, complex giant-scale system of the human body and its objective environment, of the functional states of its macroscopic systems and of the functional states of its microscopic systems, the structure of the systems and the behavior of its systems. It is pointed out in the philosophy of Marxism that there are three layers of knowledge, basic knowledge, technical knowledge, and practical knowledge. The guiding theory of somatic science is the system theory, which is the combination of the integration theory and the reduction theory, and is on the next higher plane. It conscientiously absorbs the philosophies and rationalities of Chinese medicine and the theories and technologies of Western science to advance the study of somatic science. In

(this manner, there are basic changes in the study of somatic science, and this will promote major developments in somatic science.

BIBLIOGRAPHY

1. Qian Xuelin and others, NATURE MAGAZINE, 13, 1 19 90) 1
2. Chen Xin, SCIENCE OF AIR AND MAN, Sino-Japanese cooperative conference, (1988) 45
3. Qian Xuelin and others, ON SOMATIC SCIENCE, PLA Medical Publishing Agency, (1988), 147
4. Qian Xuelin and others, EXPLORATION IN NATURE, 4, (1983), 415
5. Qian Xuelin and others, NATURE MAGAZINE, 4, 7(1988) 483
6. Yu Hefeng, SCIENCE OF AIR AND MAN, Sino-Japanese cooperative conference, (1988), 53
7. Mary F. Asterida, THE PHYSIOLOGY OF STRESS, Human Sciences Press, New York (1985)
8. Qian Xuelin, ON SOMATIC SCIENCE, PLA medical Publishing Agency, (1989) 297
9. Ibid, 282
10. Ibid, 248
11. Chen Xin and others, ON SOMATIC SCIENCE, PLA Medical Publishing Agency, (1989) 176
12. P.T. Sanders, AN INTRODUCTION TO CATASTROPHE THEORY, Cambridge University Press (1988) Translated into Chinese by Ling Fuhua, Shanghai Science and Technology Contributions Press 1983)
13. Qian Xuelin, ON SOMATIC SCIENCE, PLA Medical press, (1989) 10
14. (Japanese), Xiu Tianyong and others, PHYSIOLOGICAL RESEARCH METHODS, Medical Press (1975) 19

ACADEMIC SYMPOSIUM TO BE CONVENED BY COMMISSION ON SYSTEM THEORIES IN CHINESE MEDICINE

The system theories of Chinese medicine are an important component of the modernization of Chinese medicine. It already has a certain foundation in China and has attracted a great deal of wide-spread attention. In order to promote development in the study of the system theories of Chinese medicine and to strengthen ties, the Special Commission on Chinese Medicine System Theories of the Chinese Society of Somatic Sciences is actively organizing a conference and specialty symposium to be convened in Chengdu in the fall of 1990 to discuss the direction and special characteristics of the specialty of system theories in Chinese medicine and to study the system concepts in basic theory in Chinese medicine, especially the concept of man as an open, complex giant-scale system. The contact unit for this conference is Staff Office, Chinese Society of Somatic Sciences, Zhang Ruiyun, Post Office Box 5104, Beijing. Postal code is 100094.

SUBSCRIPTION INFORMATION

The magazine CHINESE SOMATIC SCIENCES was begun in July of 1990. Beginning in 1991, there will be four issues every year (quarterly). Post offices in all areas will handle subscriptions. Anyone desiring to subscribe to this magazine, please note carefully the subscription notifications in the post office. The publication number of this magazine is CN31-1575.

For this first issue of 1990, readers may directly send money to the Circulation Department of the Shanghai Communications University Press to buy it. The address is: 1954 Huashan Road, Shanghai. The Postal code is 200030. We request that units sending money attach a note stating that the money is for the purchase of the CHINESE SOMATIC SCIENCE magazine. You must include your address and postal code.

Editorial Department

RESEARCH INTO PARANORMAL ABILITY TO BREAK THROUGH Spatial BARRIERS

BY: Song Kongzhi, Li Xianggao and Zhou Liangzhong

SUBJECT WITH PARANORMAL ABILITIES: Zhang Baosheng

(AEROSPACE MEDICINE ENGINEERING INSTITUTE)

→ probably
military
operated

ABSTRACT

This article uses strict scientific procedures, one of a kind test samples, videotape and high speed photography to demonstrate the objective existence of the paranormal ability of breaking through spatial barriers. It also shows the physical process of this ability. It demonstrates that through the function of the paranormal ability, the macrobody was able to pass through the wall of a container and be removed, but no visible damage to the wall of the container was detected.

FORWARD:

Breaking through spatial barriers is one type of paranormal ability. The characteristics of this ability is that the person with this paranormal ability is able to remove an object placed in advance in a sealed container without damaging the seal of the container or damaging the container itself.

In China, Li Shuhuang, Zhang Chongqi¹ and eleven others discovered that persons with paranormal abilities were capable of removing such objects as M₃ nuts, nails and bundles of matches from a sealed plastic 35 mm film canister. In the canister lid there was a 1.55 mm hole, but the lid was not opened. Following this, it was discovered by the All-China Paranormal Physical abilities Joint Testing Group² that persons with paranormal abilities were able to remove the target stationary paper from a sealed kraft paper envelope.

¹ Lin Shuhuang, Zhang Chongqi and others, NATURE MAGAZINE, 4,9(1981)652

² Human Paranormal Abilities Joint Testing Group, RESEARCH IN HUMAN PARANORMAL ABILITIES, 1,1(1993)9

Then, Liu Shuhuang, Zhou Binghuang and 17 others³ conducted special research testing on breaking through spatial barriers. They not only demonstrated that persons with paranormal abilities could extract stationery from sealed kraft paper envelopes, but they could also remove insects from glass tubes with sealed caps without any discernable effect on the life or actions of the insect. At the same time, in this experiment, they also conducted an experiment where the subjects removed a sponge which had been dipped in FeCl₃ from a double layer sealed KCNS type paper bag without any visible change of coloring of the test paper. This research opened the way for research into ability to break through spatial barriers and provided a number of preliminary bases of a physical nature for this phenomenon.

On the basis of these experiments, we believed it was necessary to use even stricter methods to conduct further proof of the reality of this ability and that we should observe the process of this breakthrough and the point of penetration in order to demonstrate whether or not there was penetration of the walls of a physical object.

Therefore, the purpose of this experiment was:

1. To use a sample that once damaged could not be restored and to combine this with visual records to further demonstrate the reality of this ability.
2. To use larger and longer objects, and combine this with videotape and especially with high speed photography to observe just exactly where the three dimensional spatial barrier was broken through, and whether or not the penetration of the wall was achieved over a span of time.

MATERIALS AND METHODS USED IN THE EXPERIMENT

I. SAMPLES

1. In order to fully demonstrate the reality of the ability to break through spatial barriers, we designed the following two samples.

A. TEST SAMPLE ONE: We used sealed transparent glass bottles. The bottles were four centimeters in diameter and 12 to 13 centimeters long. Inside these bottles we placed 30 medicine tablets which were colored either red, green or purple. The tablets were 5.5 mm in diameter and three millimeters thick. Different ratios of the numbers of the different colored pills were placed in the different bottles. Each bottle was numbered individually. The numbers of each different colored tablets, the number of the sample, and the serial number of that sample bottle were all marked on the test

³ Lin Shuhuang, Zhou Binghui and others, RESEARCH IN HUMAN PARANORMAL ABILITIES, 1, 3(1983)110

labels using a binary system. The tablets were first placed in the sample bottles and then the top of the bottle was heated and closed to a small slit. Even if the tablets were broken in half there is no way they could be poured out. The sample on the right in illustration one is a sample one.

Illustration 1: To the right is sample one: the sample label gives the type number, the bottle number and the different colors of tablets. The bottle on the right I sample five, the label gives the type number and the bottle number

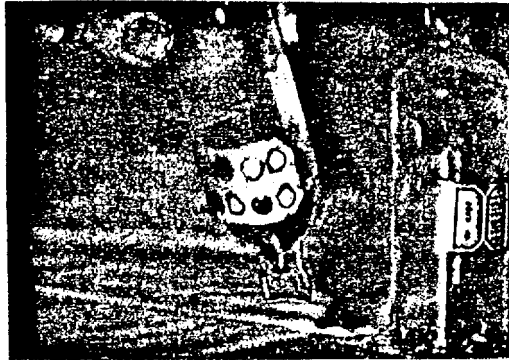

B. TEST SAMPLE FOUR: We use exactly the same type of sealed transparent test bottle as used in Sample one. However, inside were placed 15 plexiglass pieces which were red, yellow and green. The test pieces were 5 X 5 X 1.5 mm squares. The different test sample bottles contained different ratios of the different colored test pieces. Also, there was a Russian letter on each test piece. The fifteen letters formed three Russia words. Each color was a separate word. There was also a serial number on different places on the bottle indicating the serial number of the bottle. For example, four pieces of plexiglass had the Soviet letters S, O, D and A, meaning soda. On another location of S, O, D and A were added 1, 2, 3 and 4. Each test sample bottle held different ratios of the different colored pieces of plexiglass. The test pieces were first placed in the bottles, and the tops of the bottles were heated to form a slit. The test piece could not be pored out through this slit. The sample on the left of illustration one is sample four.

Each sample was one of a kind, so it could not be duplicated. The glass containers could not be put back together if they were broken and the glass was transparent which allowed for better observation.

2. In order to observe just where the objects, that is the objects which were placed into the containers beforehand, broke through the space barrier, and to see what happened to the objects and the container wall when the barrier was penetrated, we designed the following samples.

A. We used unopened CIWUJIA [exact translation unknown. Probably a Chinese over the counter medicine] and XIAOYANLIDANYAO [another over the

counter medicine for reducing fever and to help the gallbladder] bottles. These two medicine bottles are both clear glass and have a cork stopper sealed with wax as well as a plastic screw-on lid. The tablets are disc shaped, one centimeter in diameter and 0.6 centimeter thick at most. The CIWUJIA tablets are yellow sugar coated tablets and the XIAOYANLIDANYAO are blue sugar coated tablets. Each bottle contains 100 tablets. Illustration two shows the CIWUJIA unopened bottle.

Illustration 2: Unopened ciwujia bottle with 100 disc shaped yellow sugar coated tablets. The bottle is sealed with cork sealed with wax and a plastic screw on lid.



B. One-hundred milliliter dropper bottles of GAOSENPUTAOTANG [high ginseng content glucose]. These were 100 ml dropper bottles of GAOSENPUTAOTANG after clinical use. After they were washed clean, five types of capsules and tablets were placed inside the bottles. Three types of tablets were round, being one centimeter in diameter and 0.6 centimeters at the thickest. These included yellow, red, and light brown tablets all which were sugar coated. In addition there were two types of plastic cased capsules 1.5 centimeters long and 0.5 centimeters in diameter. One capsule was half red and half blue and the other capsule was all blue. There were ten of each type, 50 tablets and capsules in all. Then, the bottle was stopped with a rubber stopper, and an aluminum cap was put on with a capper (see illustration three).

Illustration 3: GAOSENPUTAOTANG dropper bottle with fifty tablets and capsules of five different types inside. It is sealed with a rubber stopper and aluminum cap



C. TEST SAMPLE FIVE: The test samples were made by heating and forming clear glass tubes. These tubes were four centimeters in diameter and 20 to 25 centimeters long. The two ends were heated and closed, and three millimeter holes in the side indicated the model number and one millimeter holes in the side indicated the bottle number. Inside the tubes was placed two meter lengths of spiraled enamel insulated wire one millimeter in diameter, the spirals were one centimeter in diameter. One end of the wire was sealed into one end of the glass tube, and the other end was free but welded to an M8 nut (see illustration four).

Illustration 4: Test sample five: clear glass tube containing two meters of 2 mm enamel coated wire, one end of the wire sealed in an end of the tube



D. SAMPLE SIX: This sample was also made by heating and forming clear glass tubes. The tubes were the same size as those in sample five. The two ends were heated and closed. At one end there was a one millimeter hole. There were no holes on the sides of the tubes. Inside the tubes were a 1.5 meter length of shielded wire one millimeter in diameter. One end of the shielded wire was sealed up into the closed end of the test tube (see illustration five).

Illustration 5: Test tube 5: clear glass tube with 1.5 m length of shielded wire inside



E. a 500 ml clear glass dropper bottle with a packet of unexposed photograph paper inside. The packet of photograph paper was connected to a 30 cm length of string and a label with "TEAC" written on. The bottle was sealed with a rubber stopper (see illustration six).

Similar to this sample was a 500 ml clear glass dropper bottle with a FUJIAN tea bag inside as well as an iron tea strainer with a packet of unexposed photography paper inside.

In the experiments using these two types of samples, in addition to ordinary videotaping, we also conducted high speed photography. Thigh sped photography was 200 frames per second, 400 frames per second and 1000 frames per second.

Illustration 6: A 500 ml clear glass bottle with a packet of unexposed photography paper inside



2. PRINCIPLES OF THE EXPERIMENTS

A. Close uninterrupted observation and video recording of the entire process of the experiments was required.

B. The test samples were not given to the paranormal ability subjects prior to the experiment. The samples being tested were not allowed to be taken away. When the experiments were over, whether the experiments succeeded or not, the test samples were all collected and were properly stored.

C. Prior to the experiment and during the experiment, a double blind was maintained for both the person administering the test and the person being tested for the coded test label for the sample.

3. PARANORMAL ABILITY SUBJECTS

Subject Z with paranormal abilities, male, 26 years old. History of tuberculosis, presently completely recovered. Normal physical development.

RESULTS OF THE EXPERIMENTS

1. A total of 50 experiments in the ability to break through of spatial obstacles were conducted. The results are condensed in table one. We can see that of the 50 experiments, 25 were successful, 17 were videotaped and high speed photography was used in six.

TABLE 1: TABLE OF EXPERIMENTS

	Practice runs	Formal experiments	Total
Total number	2	48	50
Successes	1	24	25
Number videotaped		17	17
Number photographed with high speed photography		6	6
Number of successful samples stored	0	21	21

2. EXPERIMENTS DEMONSTRATING VALIDITY

SAMPLE ONE EXPERIMENTS: There were successful results with two bottles which were also videotaped. The results are listed in table two. During both experiments the phenomenon of removal of one half a tablet occurred. This was because when the subject with paranormal abilities was exercising his abilities and exerting energy to shake the bottles, the tablets were broken in two. It should be pointed out that even though they were broken in half, they were still 1.5 mm thick, and could not come out through the slot. Furthermore, the number of tablets outside the bottle added to the number of tablets inside the bottle equalled the number of tablets started with inside the bottle, that is, 30 tablets. The number of tablets of each color outside the bottle plus the number of each color tablet inside the bottle after the experiment came to the corresponding number of each color prior to the experiment. There was no damage to the bottles.

TABLE 2: SUCCESSFUL RESULTS SAMPLE ONE EXPERIMENT

Serial number	Number of tablets				Date the experiment concluded
	Red	Green	Purple	Total	
18 Originally Number removed	10	11	9 1.5	30 1.5	Nov. 16, 1983
1 Originally Number removed	10 1	10 2	10 0.5	10 3.5	Nov. 18, 1983

There were three experiments with sample five. The detailed results are shown in table three. We find from the table that five pieces, D, T, G, Y and T were removed from bottle one. From bottle four, three pieces, O, E, and E were removed. From bottle eight, three pieces, D, O and L were removed. The test pieces removed were the same pieces found missing from the bottles after the experiment, matching the missing pieces' number, color, letter and code. However, the glass bottle was not damaged. See illustration seven.

Illustration 7: First from left is sample bottle one with 15 pieces of plexiglass. Second from left is same bottle but five pieces have been removed. Bottle still contains ten pieces. Third from left is sample bottle eight containing 15 pieces of plexiglass. Fourth from left is the same bottle but three pieces have been removed and the bottle still contains 12 pieces.

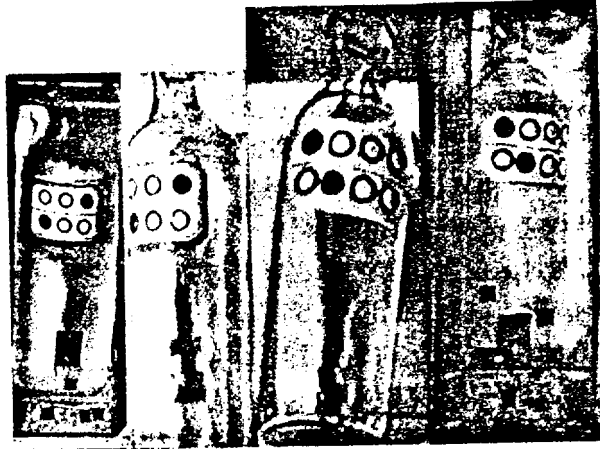

In the experiment described above, the test pieces, coding and double blind as well as the samples, were not given to the subject prior to the experiment, therefore, the test samples could not be prepared beforehand. At the experiment location, the main person administering the test and other testing personnel continuously watched, and also the videotape methods eliminated the possibility of switching bottles. Furthermore, if the bottles were destroyed, it would be impossible to put them back together, eliminating the possibility of taking the container apart. The transparency of the glass ensured that the objects inside could be seen. Under the assurances of these conditions, the results described above completely proves the objects were actually removed from the bottle by the subject using paranormal abilities. This is the ability of breaking through spatial obstacles.

TABLE THREE: SUCCESSFUL RESULTS OF EXPERIMENTS WITH SAMPLE FIVE

Serial number	Plexiglass pieces			No. of pieces	Date experiment completed
	Red	Yellow	Green		
1. Letter and code of piece removed				15 5	10 Dec 83
2. Letter and code of piece removed				15 3	28 Dec 83
3. Letter and code of piece removed				15 3	30 Dec 83

3. OBSERVATION OF THE BREAK THROUGH POINTS

A. The unopened tablet bottle experiment results are shown in table four. Some of the results of the videotaping are shown in illustration eight. These demonstrate that tablets were actually removed from the unopened bottle with its original seal without breaking the bottle. What is especially clear is the CIWUJIA medicine bottle experiment seen with high speed photography of 400 frames per second. (See photographs inside front cover) the photographs show this result. It is a group of continuous frames. In the first frame, there is no tablet visible outside the bottom or side of the glass. In the second frame, slightly outside the bottom of the glass, two-thirds of a tablet is sticking outside the glass. The tablet interfaced with the glass along the side of the bottom of the bottle which can be diagrammed as follow:

ILLUSTRATION 10: DIAGRAM OF TABLET BREAKING THROUGH



TABLE FOUR: RESULTS OF SUCCESSFUL TABLET EXPERIMENTS

Name of medicine	Seal	Size of tablets	Number in unopened container	Number removed	Number remaining	Date completed
CIWUJIA	Unopened original container, cork stopper sealed with wax and plastic screw on lid	Disk shaped 10 mm in diameter and 6 mm thick	100	62		29 Apr 84
XIAOYANLI-DANPIAN	Original unopened container, cork stopper sealed with wax and plastic screw on lid.	Disk shaped, 10 mm in diameter and 6 mm thick	100	44		4 May 84
FIVE DIFFERENT TYPES MIXED TOGETHER	A 100 ml high ginseng content glucose dropper bottle with a rubber and an aluminum cap.	Yellow, red and light brown tablets were 10mm diameter and six mm thick; 10 the blue and red/blue gel capsules were 15 mm long and 5mm in diameter	10 10 10 10 10	5 1 3 5 2	5 9 7 5 8	7 May 84

Frame three, this tablet is already three mm from the bottom of the bottle. The tablet is one centimeter in diameter.

Similar to this was the removal of unexposed photograph paper from the 500 ml dropper bottle and the removal of unexposed photograph paper from the iron tea leaf tube. The unexposed photograph paper was all unexposed. Illustration 11 shows the removal of unexposed photograph paper from a 500 ml bottle as captured on videotape. It is a continuous process, with each frame 40 milliseconds. Beginning with frame four, the photograph paper appears outside the bottle. In frame five it is half in and half out, and the 2.5 X 3.5 cm flat packet is parallel to the surface of the table, cutting through the side of the bottle horizontally. In the sixth frame it is completely removed. This demonstrates the entire process of a solid object breaking through the wall of a container and shows the object half in and half out of the container.

Illustration 11: Videotaped continuous process of removal of unexposed photograph paper through a 500 ml dropper bottle. Each frame is 40 ms.



1: THIS IS FIRST FRAME



2: THIS IS SECOND FRAME



3: This is third frame



4: This is fourth frame. Small portion of unexposed paper appears outside of glass



5: Fifth frame: half of unexposed paper appears outside of glass. other half is inside the glass, darker portion above packet. The 2.5 x 3.5 Packet comes out flat.



6: sixth frame: most of unexposed paper is outside of glass



7: Seventh frame: unexposed
packet of paper already totally
outside the glass

The results of this group of experiments not only demonstrates that the break through point is the wall of the container, but that the break through of the obstacle occurs in a time sequence.

B. RESULTS OF EXPERIMENTS WITH CONTINUOUS TARGET OBJECT SAMPLES

The results of the experiments with samples 5 and 6 are shown in table 5. In the type of sample bottles used in samples six, there is only a 1mm hole in one end of the bottle. The removal of the iron washer with its shielded wire from inside this bottle without damaging the original seal is unquestionably further proof of the reality of paranormal abilities. From the videotape of this experiment it can be seen that the process of the fingers pinching one end of the wire, causing the shielded wire inside the glass to follow the movements of the fingers outside the glass in a shearing motion. As shown in illustration 12, from frame two to frame seven are the continuous video tape results. The space between each picture are four frames. It is possible to see the subject with paranormal abilities pinch the end of the shielded wire between the thumb and forefinger of his right hand. As his fingers move twice, the shield wire inside the bottle appear to make the same movements. Interestingly, although it appears to be making a shearing motion horizontally against the wall of the container, it did not leave any mark on the wall of the container which is visible to the naked eye. This is similar to the tablet breaking through the medicine bottle.

Table 5

Serial number	Target object	Results	Record made	Date completed
Sample V no.12	2mm diameter single strand enamel wire coil	Pulled out three sections	Videotaped	2 Apr 84
Sample 5 no.13	2 m diameter single strand enamel wire coil	Pulled out five sections	Videotape and photograph	10 May 84
Sample six A	1.5 mm single strand shielded wire	Pulled out two sections	Videotaped	25 Apr 84
Sample six B	1.5 mm single strand shielded wire with washer affixed to end	Pulled out four sections and one washer. The wire inside broke into three sections	Videotaped and photographed	28 Apr 84

Illustration 12: Video taped results of the sample six experiment spacing between pictures is four frames

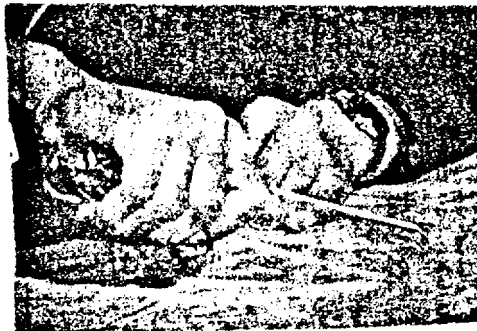

1: This is the sample bottle with the 1.5 M shielded wire inside



2: Frame one. Right thumb and forefinger pinching wire

Frame two: wire moves down in bottle

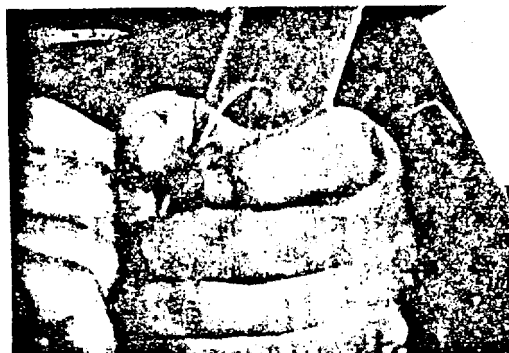

4: Frame three: wire continues to drop in bottle

5: Frame four: wire continues to drop



6: Frame five: wire continues to drop

7: Frame six: wire is coiled up toward the left in the bottle

DISCUSSION.

1. The question of the validity of paranormal ability to break through spatial barriers.

We can see from the results described above that as one of the paranormal abilities, the ability to break through spatial barriers actually exists. The sample bottles type one and type four were glass which had been heated to form the mouth almost shut. If these bottles were broken, they could not be put back together, any breakage would be irreversible. Furthermore, each sample had a unique serial number and the target objects were of different colors, and there were different numbers of each different color. The target objects also had russian letters and codes as well as dots. Each sample had thorough video

taping equipment from all angles, ensuring their individual characteristics formed during heating. The information totalled together forms one of a kind samples. It would be impossible to copy these samples. In addition, prior to the experiment, the subject had no contact with the test samples and had no ideal of the form or coding of the target objects. The test subject only came in contact with the samples at the experiment site. Therefore, first, copy of samples was impossible, so switching of containers became meaningless. Second, the glass bottles could not be broken. Third, the samples could not leave the testing site, and there was always someone watching the testing site, and at key times there were video taping or high speed photographing of the tests. Under such conditions, the number, color, serial number and coding of tablets or plexiglass pieces on the experiment table exactly matched those in the sample bottles. This allows us to only reach one conclusion: that the tablets and pieces of plexiglass were passed through the walls of the container.

Also, in the experiment with the sample six bottles, there was only a one mm small hole in one end of the glass bottle and the shielded wire in the bottle was one mm in diameter. This type of one mm shielded wire has many frays at the end (shielded wire is formed from braiding fine metal wires). Even if we used our hand to directly pinch this end of the wire so it would go through a hole the same size, it would be a difficult task. However, this wire was placed inside a glass tube, and there was a 7 mm iron washer there as well. Without breaking the glass bottle, three to five sections were removed and the washer appeared on the outside. The shielded wire on the inside was broken and there were several sections of sections of wire three to ten mm long and the washer was gone. Without a doubt this proves that the shielded wire and the washer passed through the wall of the container to the outside of the container. However, the glass was not broken. Therefore, it could only have been a type of paranormal ability that caused to be outside the glass. We should explain that this type of experiment had a high degree of one of a kind. Because of the thickness and length of the samples, the method of securing the wire inside, and the closing of both ends all had their own special characteristics that would be difficult to duplicate. Furthermore, the samples were very long and it would be difficult to switch them undetected. In addition, there were videotaping procedures, ensuring the strictness of the experiments.

2. CONCERNING THE POINT OF BREAKING THROUGH

In these experiments, we can see fairly clearly the phenomenon of the target objects passing through the walls of the container. This phenomenon tells us:

A. The breaking through point cannot be a hole in the container, a slit in the container or the edges of the seal but is directly through the wall of the container. In the experiments with clear glass containers and relatively small target objects, we can also see them become larger during the process of the target objects passing through. Also, in the experiments where the container and the transparent target object were all relatively large, we could

see the target objects being both inside and outside the container, the changes and the cutting through phenomena.

B. The targets passed through the walls of the containers at different speeds. In the experiment with the CIWUJIA bottles, it took around 2.5 milliseconds for two-thirds of a tablet one centimeter in diameter to pass through the wall of the container. The average speed was $V = 7\text{mm}/2.5 \text{ ms} = 2.8$ meters per second.

Assuming that they passed through at a uniform speed, the speed would be at this level. Somewhat slower than the speed at which an athlete runs.

The removal of the unexposed photographic paper packet from the 500 ml dropper bottle took more than 10 milliseconds, or a speed of 30 cm/second.

For pulling shielded wire or enamel wire from a glass tube, the speed could be even slower, or stop for several seconds.

Therefore, we can see from these experiments that the speed at which solid target objects pass through spatial barriers can be very slow, speeds slow enough to be followed by the human eye. However there were also changes. We reason that often we are not able to see the processes because the walls are too thin. These are granular shaped target objects passing through thin walls in a number of milliseconds. High speed cameras or slow motion video cameras can show the visible time progression. This more clearly proves the objective reality of the paranormal ability of breaking through spatial barriers.

C. In the process of the experiments the walls of the containers have to have a slit, small hole or stopper for the experiment to succeed. The objects cannot be removed from a completely closed container. However, in these experiments we discovered that the point at which the objects pass through the spatial barrier is not at the slit, the hole or between the wall and the stopper, but is in the wall of the container. What then, is the significance of the slit, hole or border between the stopper and the wall of the container? Is it a psychological requirement or a physical requirement? This is something that requires further study.

CONCLUSIONS

From the analysis of the video tapes and high speed photographs of 25 successful experiments in breaking through spatial barriers by a young subject with paranormal abilities, we have proved the existence of one type of paranormal ability - the ability to pass through spatial barriers, that the pass through point can be the wall of the container, and furthermore, that the passing through the walls occurs over a period of time.

APPRECIATION: During the process of these experiments we were aided by chairman Zhang Zhenhuan and comrade Qian Xuelin. We received guidance from Office Chief Chen Xin and Associate Professor Wang Xiubi. We were directly assisted by comrades Zhai Yanxiang, Jiang Gongzhi, Chen Zhiming, Liu Yuezi, Tian Huilai, Liu Min, Cheng Meiyu, Liu Hu, Li Chenxiang, Wei Yanfang and Yao Wenlan. We would like to show our appreciation to all these individuals here.

INVESTIGATION INTO THE "FORCE" IN PARAPSYCHOLOGICAL WRITING

BY: Huang Jinggen, Yu Xinghai and Shao Laijing

(Fudan University)

ABSTRACT

This article discusses use of a mechanical balance, a thermobalance and piezoelectric crystal to study the "force" in parapsychological writing. Within the scope of measurements during the experiment, no measurable "force" was observed during parapsychological writing. The authors discuss the results in the light of wave and particle dualism of matter.

"Parapsychological writing" is one form of human paranormal ability which has been demonstrated by a large number of experiments (1-5). "Parapsychological writing" includes a number of complex parapsychological phenomenon including moving the writing instrument, breaking through spatial barriers and thought directed writing. These paranormal phenomenon cannot be explained using modern scientific knowledge. However, the recording of paranormal phenomena, especially of the accumulation of data on experiments conducted using strict scientific methods must eventually approach and disclose the truth about this unknown realm. In "parapsychological writing" is there a "force" which corresponds to the movements of the "writing"? This is a major topic in the thoroughgoing research into parapsychological writing. The authors used a mechanical balance, a thermobalance and piezoelectric crystal to investigate the force in parapsychological writing. We discovered that it was a type of "imaginary force" that accompanies the movements of parapsychological writing. Within the parameters of measurement in the experiment, there was no common physical measurable quality.

THE EXPERIMENTS

1. THE MECHANICAL BALANCE

The balance was a semiautomatic TG328B balance. It has a glass cover. Its lower limit is 0.1 mg. On the left hand plate of the balance we placed a plastic film canister. Inside the film canister we placed a square of white paper. The lid to the film canister was open just a crack. On the right hand plate of the balance we placed a weight piece of equal weight so the balance would be kept level with the pointer at the zero marking (see illustration one). After observing for five minutes, there was no movement in the pointer. However, it would move if one less or one more mg weight piece would be added. On a concrete platform outside the balance cover we placed a fountain pen. The

test subject was Little Ji. The experiment required that she use her thought to "write" or "draw" on the paper in the film canister with a black ink fountain pen. She was to concentrate her thoughts on this to the exception of everything else. We conducted a total of nine experiments, of which three were successful. Each experiment lasted for 15 to 25 minutes. The words and drawings were all black like the ink in the fountain pen used in the experiment. In the three successful experiments, two had clear characters and drawings (see illustration two) and the other had fairly blurry circles and dots. Neither of two observers saw the mechanical balance move at all, demonstrating that the film canister was not under any observable "outside force".

ILLUSTRATION ONE: DIAGRAM OF THE MECHANICAL BALANCE

1. Film canister
2. Blank paper
3. Pointer
4. Scale graduations
5. Glass cover
6. Balance pan

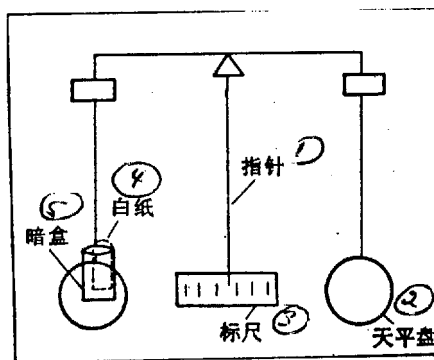
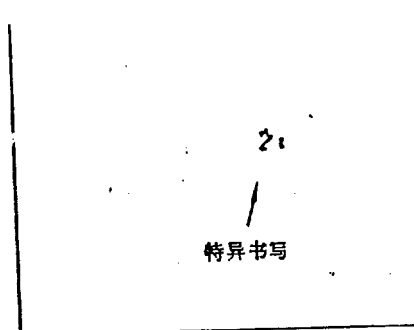
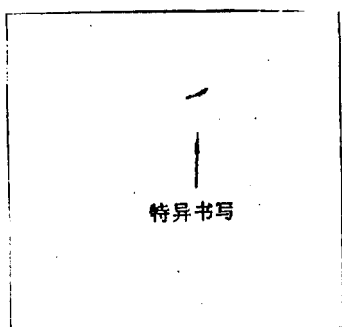

ILLUSTRATION TWO: RESULTS WITH MECHANICAL BALANCE



A. 8 MAY 1989

12 MAY, 1989

1. Parapsychological writing

2. THE THERMOBALANCE

A thermobalance is an instrument which gives a continuous recording of the relationship between mass and temperature. Normally, the procedure is to control the temperature by heating or cooling the sample material or to maintain the sample at a constant temperature. In our experiments, the temperature was constant at room temperature, and the lowest measurable unit was 0.05 mg. Illustration three shows a diagram of the arrangement. In the experiment a blank piece of tape was stuck to the crucible arm, the arm was covered with a glass tube to keep air currents from affecting the experiment. The test subject, Little Ji, sat at the edge of the table 0.5 meters from the balance with her back to the instrument. On the table we placed a fountain pen (to discriminate colors we used fountain pens with blue and green ink). The experiment required that the subject use her thoughts to "write" on the white tape with the fountain pen. During the experiment, those administering the experiment always observed the progress of the experiment from the side, and the automatic recorder drew the weight/time graph. Ten experiments were conducted in all, and three of these were successful. Each experiment lasted approximately 20 minutes. The "writing" was always dots and the same color as the ink used in the fountain pens in the experiment. On one occasion the "writing" was green, and on two occasions it was blue.

ILLUSTRATION THREE: DIAGRAM OF THERMOBALANCE ARRANGEMENT

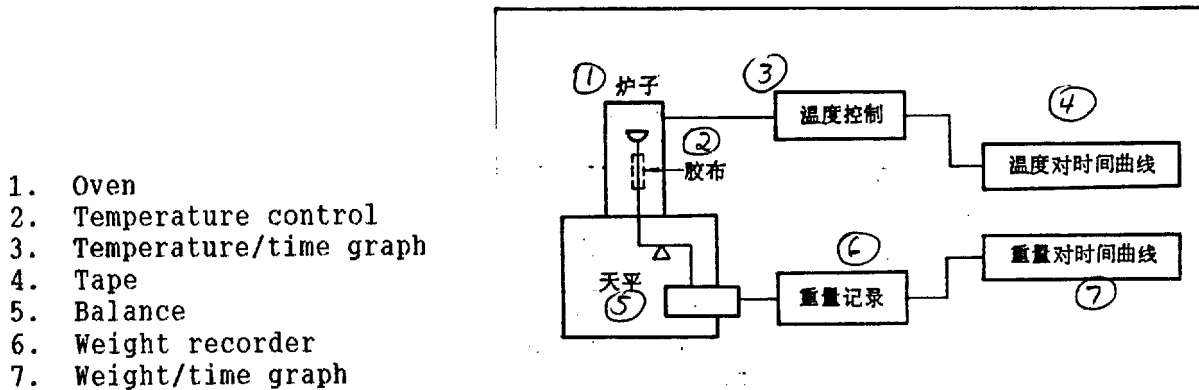

Illustrations four and five show the dots "written" on the tape mentally by Little Ji. The automatic recorder weight/time graph came out as a straight line. There was no change in weight, demonstrating that there was no function of "force" in the "parapsychological writing".

ILLUSTRATION FOUR: RESULTS OF THE THERMOBALANCE EXPERIMENT. 20 MARCH, 1989
THE "PARAPSYCHOLOGICAL WRITING" DOT WAS BLUE

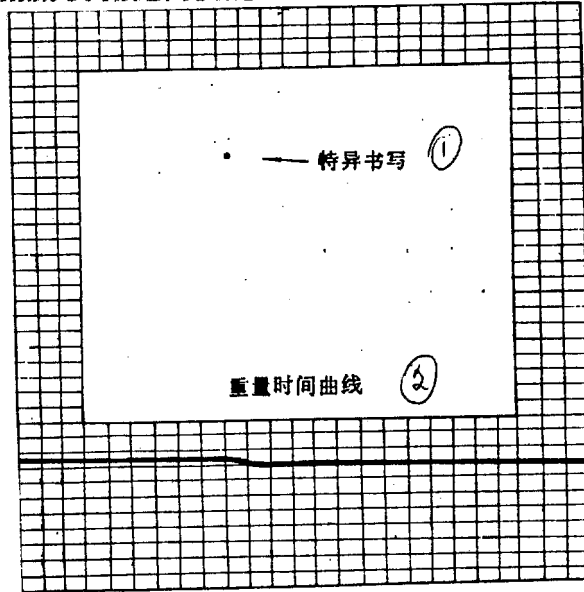
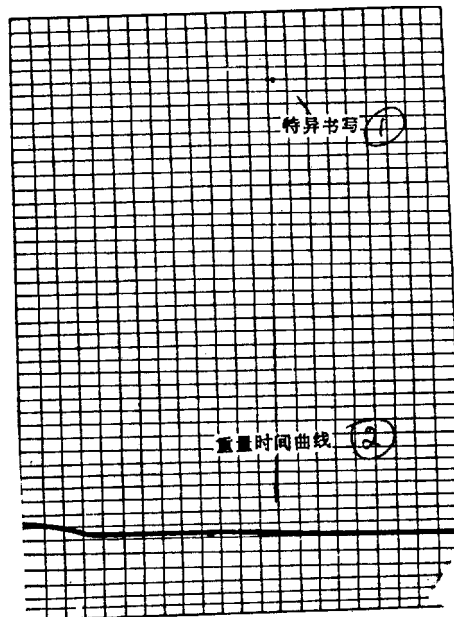

ILLUSTRATION FIVE: RESULT OF THERMOBALANCE EXPERIMENT 18 APRIL, 1989
THE "PARAPSYCHOLOGICAL WRITING DOT WAS GREEN.



1. Parapsychological writing
2. Weight/time graph

3. THE PIEZOELECTRIC CRYSTAL

The arrangement for the experiment was as shown in illustration six. The experiment was conducted using four subjects with parapsychological abilities in turn. A square piece of blank paper was stuck to a piezoelectric ceramic strip in a paper box (in some of the experiments, double faced carbon paper was inserted between the piezoelectric crystal and the blank paper). The experiment required the subjects to use their thoughts to write a line or character on the blank paper. In the ten successful experiments, there was no electrical signal transmitted by the piezoelectric detector (see illustration seven), demonstrating that the piezoelectric sensor was not able to detect the force of the "parapsychological writing" no difference could be detected either when the fountain pen was "present" or "not present" on the piezoelectric crystal.

ILLUSTRATION SIX: DIAGRAM OF ARRANGEMENT OF PIEZOELECTRIC CRYSTAL EXPERIMENT

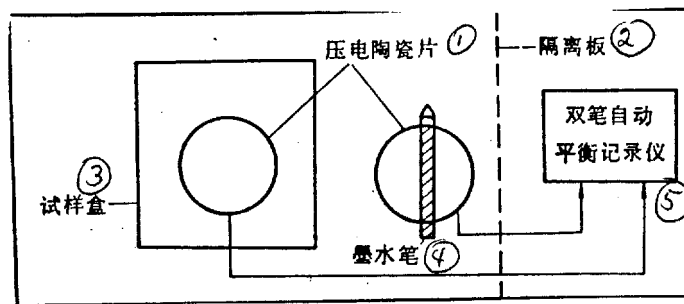

1. Piezoelectric crystal
2. Isolation board
3. Sample box
4. Fountain pen
5. Double line automatic balance recorder

We suspected that the subjects with parapsychological abilities might be able to transmit some kind of signal energy during the parapsychological writing experiment that would cause the a break in the signal given off by the piezoelectric crystal. Therefore, we used two piezoelectric plates glued together. One plate transmitted a low frequency alternating current signal, and the other plate was used for the parapsychological writing. The signal was the superimposition of the two individual signals. If the electrical signal was cut off, there would be a break in the low frequency signal on the recorded graph. However, this never happened. Therefore, such suspicions were eliminated.

ILLUSTRATION SEVEN: PIEZOELECTRIC CERAMIC EXPERIMENT.
THE "PARAPSYCHOLOGICAL WRITING" IS A HORIZONTAL LINE, BUT THE
PIEZOELECTRIC PLATE DID NOT GIVE OFF ANY SIGNAL

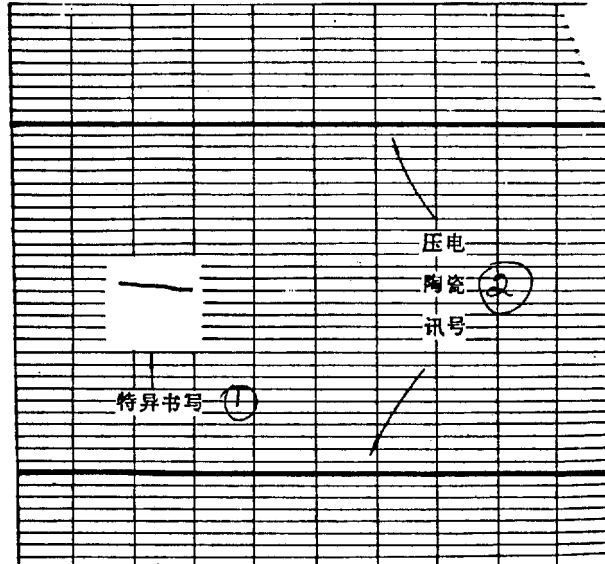

1. Parapsychological writing
2. Piezoelectric ceramic signal

DISCUSSION

The results of the experiments with the mechanical balance, thermobalance and piezoelectric crystal are combined in table one. From these experiments we can reach the following conclusions. 1. There is no observable "external force" functioning in "parapsychological writing" or 2. If an "external force" is playing a role, then it occurs extremely quickly so the recorder or the balance does not have time enough to react. We used our hand and paper to test the experiment instruments maximum speed (about five mg over 0.1 second), and the instruments were always able to record or react to the stimulus. Therefore, if there actually is a "external force" at work in "parapsychological writing" it works over a time of less than 0.1 second. However, considering that prior to the subjects with parapsychological abilities completing the "parapsychological writing", they must still go through the process of "moving the pen" and "breaking through the spatial barrier", and it seems that the possibility is not very great that all these actions are not detectible or "recordable" because they happen too quickly. Therefore, we lean toward the conclusion that there is no "external force" at work in "parapsychological writing".

The actions "moving the pen", "breaking through spatial barriers" and "effortless writing" in the process of "parapsychological writing" cannot be explained using current knowledge. We envisage that "wave and particle dualism

of nature" may be one way to explain it. First, we hypothesize that: If, just as microscopic particles such as photons, electrons and neutrons have dual wave and particle natures, so do macroscopic bodies (such as matter) have dual wave and particle natures, then such matter waves could be viewed as the macroscopic layer de Broglie wave, and according to the principles of quantum physics, only moving particles have "wave" characteristics. Thus, here we hypothesize that macroscopic matter at rest also has a wave nature. This first of all, already is a change to the concepts of quantum physics. Presently, there is no experimental basis for such a change. There is only a hypothesis, a hypothesis to explain the phenomenon of paranormal abilities.

TABLE ONE: COMBINED RESULTS FROM THE EXPERIMENTS WITH THE MECHANICAL BALANCE, THERMOBALANCE AND THE PIEZOELECTRIC CRYSTAL

	Number of experiments	Number of successful experiments	Contents of parapsychological writing	Force function
Mechanical balance	9	3	Symbols and horizontal lines	None
Thermobalance	10	3	Dots	None
Piezoelectric crystal	More than 20 times	10	Symbols and horizontal lines	None

It is currently generally believed that "persons with paranormal abilities" can only manifest "paranormal phenomenon" when they enter a "functional state." If the state which normally exists were called the "basic state", then the "functional state" could be called the "state of excitation". We hypothesize that the "state of excitation" is not a single state but a multiplicity of states, and the person with paranormal abilities carries out "paranormal actions" under different "states of excitation." That persons with paranormal abilities transmit "thought waves" of different frequencies under different "states of excitation." When these "thought waves" come into resonance with the "matter waves" of the object being used, the "matter waves" dispersed by the matter in a condensed state being used will be greatly increased from their original very small amount. When the person with paranormal abilities conducts "parapsychological writing", from what they tell us, they first use their thoughts to imagine the "pen" and when the "pen" appears in their "mind", they imagine the object on which the pen is to write (paper, tape, etc). Finally, the "pen" will suddenly write or make a mark on

the paper or tape in their minds with a flash and the process is over. There are also times when the person will use thought to image the paper or tape and then to imagine the "pen" , and finally the flash described above. Generally, the person need only see the objects in the mind and finally to have the "flash, and the experiment is usually a success. We feel that the thought imagining of the person with paranormal abilities is the process of entering the "state of excitation". When the "imagined" object appears in the "mind", the wave band of the "state of excitation" which the subject has entered is in resonance with the "matter wave" of the object being imagined. With different objects being imagined, the subjects enters different "states of excitation. Only when the object being imagined appears in the mind of the subject is there any possibility of success. It would seem that the corresponding resonance of the "thought waves" of the "state of excitation" and the "matter waves" might be an major condition for "paranormal abilities" to occur. Because of the resonance, the "matter waves" will be much stronger, and using the "pen" for example, after the "pen" waves have been greatly intensified, they will pass through the "spatial barrier" and "act" on the blank paper or tape. Only when this type of "force" has reached a certain intensity will the "pen" be able to make a mark on the blank paper. This is the final "flash" in the mind of the person with paranormal abilities. However, this final "flash" may also be hypothesized to be the person with paranormal abilities entering a new "state of excitation", The "thought waves" of this "state of excitation" could cause the "pen's" "matter waves" to and the "paper's" "matter waves" in the subjects mind to produce an effect and result in "writing" being produced on the paper (this situation is similar to the effect of a catalyst in chemistry). Because the effect is produced in the form of waves, it would not have any measurable mass, and although there would be signs of "writing" left behind, it would not manifest any quantity of "force".

The discussion above, is actually only an hypothesis, and our purpose is to throw out some initial ideas to attract others' opinions and to open up the avenue of new thinking.

The discussion portion of this work was accomplished with the participation of comrades Yan Yuanzhuang, Fang Linhu, Zhou Yingqi, Zeng Siding and Ni Dexiang who all provided their valuable opinions. We take this opportunity to express our appreciation.

BIBLIOGRAPHY

1. Joint Testing Group for Somatic Paranormal Abilities, "Research in Somatic Paranormal Abilities", 1(1983)19.
2. He Qingnian and others, *ibid*, 2(1984)58
3. Shao Guangda, *ibid*, 1,2(1985)17
4. Zhang Ming and others, *ibid*, 1,2(1987)9
5. Weng Taimeng and others, *ibid*, 1(1989)14

EVIDENCE OF THE EXISTENCE OF ABNORMAL STATES OF MATTER

BY: Wu Banghui

ABSTRACT

This article introduces a real repeatable example. It illustrates that a type of macroscopically observable abnormal physical state can exist in matter. This type of state is related to somatic states, and this state is interchangeable with the normal state of matter.

Causing the object being acted upon to "pass through walls" (that is "breakthrough spacial barriers") is a relatively stable ability of Zhang Baosheng, a person with paranormal abilities. He has repeated this ability many times.^{1,2} Pictures one and two are taken from a videotape of an experiment in "breaking through spacial barriers".

The bottle in the picture is a 500 ml intravenous solution bottle prepared by the researchers. The mouth of the bottle was sealed with a rubber stopper. The object in the bottle is a 30 cm length of sewing thread. One of the thread ends is tied to a 4 X 5 cm² piece of photographic paper wrapped in black paper and white paper. The other end is tied to a label strip. On the strip were written the letters "PRK". Zhang Baoshen used his paranormal functions to remove the object from the side of the bottle near the bottom. After it was removed, the object and the bottle were intact, and no damage could be detected by the human eye.

During the process of this experiment, the most startling thing was the object (sewing thread and paper) and the wall of the container (glass) melding together as shown in illustrations one and two.

ILLUSTRATION ONE: MELDING TOGETHER OF THE THREAD AND WALL OF THE GLASS CONTAINER

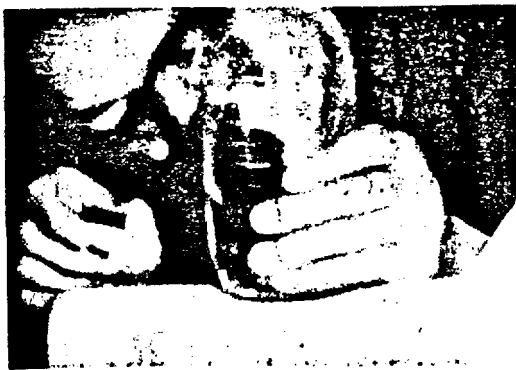

1(A). MELDING THREAD AND WALL OF BOTTLE 1(B). MELDING OF PAPER AND BOTTLE

Also, the videotape shows the thread melded in the glass can also be moved on the wall. It took four seconds for the object to pass through the wall of the bottle. For the middle and last piece of paper it took about 1/5 of a second.

Obviously, objects in the process of passing through the wall (in what is normally called the "intermediate state") and the container (at least those portions which are melded together and the string moving on the wall of the bottle), are of a nature which is not of the ordinary solid, liquid, gaseous or plasma form. This determination can be made directly based from the following reasons:

1. Before and after "passing through the wall", the object and the container's wall are both complete. Therefore, when they are melded together they could not be in an ordinary solid state. In addition, (at least as can be determined by the video tape), even though they are melded together, those portions of the container's wall and the object which are not melded together, still maintain a definite shape. Therefore, they could not be in an ordinary gaseous, plasma, or liquid state. Also, the portions melded together could not be in an ordinary gaseous or solid state. This is clear because the thread and paper cannot be turned into a gas or liquid, and could not be restored to their normal state after being turned into gas or liquid.

2. The phenomenon of the thread moving on the glass would not be possible if it were in a solid, liquid, gaseous or plasma state.

3. Normally, not much time is required for "penetrating the wall." For example, in more frequently observed experiments where a medicine tablet is passed through a container's wall, it normally takes no more than a few seconds.

4. During the entire process of the experiment, the person with paranormal abilities was able to use a container with the sample object inside (prepared by the experimenter), and did not come in contact with any special equipment.

Therefore, we have reason to believe in this "breakthrough of spacial barrier" experiment, the "intermediate state" we have captured is not only evidence of the ability to "penetrate walls", but more importantly, it's profound and basic significance lies in its showing, when acted upon by a person with paranormal abilities, photograph paper, thread, and glass can be placed into a paranormal state. Furthermore, there are macroscopic yardsticks for time and space for this type of state. Because they are different, and formed under the influence of a person with paranormal abilities, without more knowledge, we can call them "paranormal states" for the time being in order to differentiate them from the normal states of matter.

In this manner, direct observation can tell us at least the following:

1. Certain objects when acted up on by persons with paranormal abilities can be put into an abnormal state different from the normal states of matter.

2. It is possible to switch back and forth from normal to abnormal states.

3. Because no object has yet been found which can remain in a paranormal state for a long period of time after the functions have been eliminated, it may be believed being "under the influence of paranormal functions" is a condition of the existence of a paranormal state. In the terminology of physics, "the paranormal state" may be a strong coupling state between the somatic paranormal and material state. It will require further investigation to determine whether or not the abnormal state can be maintained for long periods of time after the somatic state returns to the normal from the paranormal.

In addition, it is important to note this "breaking through spacial barriers" experiment was repeated several times with the same results. ³. Therefore, we have plenty of reason to believe in the existence of an abnormal material state. The author believes the research into somatic science is important to prove this theory to be factual. The existence of this state is also noteworthy for the physical sciences even though its existence is outside the realm of current physical theories. Conscientious analysis should be performed on experimental data currently available, and targeted experiments should be conducted to capture more evidence of the existence of abnormal states for further study; the conditions under which it is generated and exists, the relationship between the abnormal state of matter and somatic abnormal functions, and the laws governing the transferring back and forth from the normal to abnormal state. This is a major breakthrough in the research of somatic sciences. This may hold hope for breakthroughs in somatic and physical sciences.

ILLUSTRATION TWO: MELDING OF PAPER AND GLASS IN THE "PASSING THROUGH PROCESS"



2(a): MELDING OF STRING AND BOTTLE

2(B): MELDING OF PAPER AND BOTTLE

BIBLIOGRAPHY

1. The Joint Testing Group for Somatic Paranormal Functions, RESEARCH IN SOMATIC PARANORMAL FUNCTIONS (1983) 9
2. Song Kongzhi and others, JOURNAL OF CHINESE SOMATIC SCIENCE, First Issue, (1990), 22
3. Lin Shuhuang, Zhang Chongqi and others RESEARCH IN SOMATIC PARANORMAL FUNCTIONS, 1,3 (1983) 110

NOTE: Videotaping was provided by the Space Medical Engineering Institute. Pictures were shot by Zeng YongQun.

OPENING ADDRESS TO THE SECOND SESSION OF THE SECOND ALL-CHINA
ACADEMIC SYMPOSIUM OF THE CHINESE SOCIETY FOR SOMATIC SCIENCE

BY: Zhang Zhenhuan

14 November, 1989

At the convening of the second session of the All-China academic exchange symposium of The Chinese Society for Somatic Science, I would first of all like to express my enthusiastic welcome to all the comrades and friends attending this symposium.

Three years have passed since the Chinese Society of Somatic Science conference (this was also the first session of the All-China academic symposium) which was held in Beijing in May of 1986. At the first All-China symposium, in order to better promote the development of somatic science, we proposed doing a good job in ideological construction, organizational construction and academic construction. At the opening of this second All-China academic symposium, I believe I must say a few words about the progress in these areas.

(1). As for the leading ideology of somatic science studies, it should be said that our recognition is even clearer and even more profound.

At the opening of the previous symposium, I made the general proposals concerning the leading ideology for somatic science studies: "We should be led by the philosophy of Marxism, use the advanced accomplishments of modern science and technology, absorb the essence of China's ancient culture, and commit ourselves to the spirit of science in our studies in somatic science in order to gradually place somatic science on the scientific track." The events and experience of the past few years demonstrate that this leading ideology is compatible to the reality. At the same time, our awareness has continued to advance. Not long ago, Comrade Qian Xuelin once again proposed the following thesis: "In recent years, the comrades in our systems science discussion group have come up with the concept of an open, complex giant-scale system and maintain that the human body is an open, complex giant-scale system. Therefore, old methods will not supply answers in the studies into Qigong and somatic sciences. The mechanical materialism type of reduction theory will not work, and neither will the "materialistic" ways of thinking and doing things. The only hope is for the methods of the philosophy of Marxism, which is the methods of dialectical materialism."

From this thesis we can point out even more clearly:

1. If we are to resolutely maintain the philosophy of Marxism as our compass, we must then oppose the mechanical materialism type of reduction theory, and we must not be apologetic for the materialism ways of thinking and doing things. This is undoubtedly an extremely important yardstick for our application of the advanced achievements of modern science and technology and for our absorbing the essence of China's ancient culture. It is something

which each of us who has dedicated himself to the study of somatic science must struggle to grasp.

2. The target of somatic science is the human body, and the human body is not an isolated, simple system. It is an open, complex giant-scale system. This has determined when we study somatic sciences, we must work hard to learn and apply the theories and methods of system sciences.

It is just because of these proper ideological guidelines I have mentioned the study of somatic sciences in China is solid and is steadily moving forward at its own new cadence.

(2). There have been good achievements in academic construction in somatic science. The major achievements have been:

1. Comrade Qian Xuelin has watched the progress of somatic science all along, and has published a number of papers concerning a series of theories and methods of somatic science. This has played a key major role in providing guidance for the advancement of studies in somatic science. At the end of 1988, the book ON SOMATIC SCIENCE was published by the PLA Military Medicine Press. This book systematically collected the treatises on somatic sciences by Qian Xuelin and other comrades. This year the Sichuan Educational Press published the book THE FOUNDING OF SOMATIC SCIENCE. The contents and scope of this book were somewhat broader. These treatises fairly completely reflect the new advances made in the past so many years in research in the field of somatic science. They illustrate somatic science is expanding into research of new subjects which may lead to a new scientific revolution.

2. There have been many newly discovered phenomena which have duplicated in experiments and have been proven. This point will be specifically shown at this symposium. I hope everyone expands the scope of the questions on the basis of full exchange. I will not address the specific content here.

3. We have discovered certain patterns in research methods.

4. Over the past several years, institutes of higher learning all over China have set up elective classes in "Study in Somatic Paranormal Functions and Qigong". The Beijing University only recently approved such a class. The Sichuan University and the Beijing Normal College have also set up similar classes. This plays a role in sewing the seeds for college students learning the new field of somatic science. The Beijing University also has a few young instructors who participate in the scientific research into the somatic paranormal functions and Qigong. It is easy to see that the setting up of elective classes in somatic sciences and preparing special reports is undoubtedly an effective means of training the future generation of forces in our field and it opens up an excellent training ground for these people.

With the support of departments concerned, the Beijing University has also set up a somatic paranormal function experimental laboratory. Such institutes of higher learning as the Sichuan University, the Shanghai Communications

University and the Beijing Physics and Engineering University have established somatic paranormal function research and biological medical engineering instructional research laboratories. These have formed a relatively sound foundation for research. There are also a few colleges and universities which I will not list here.

As for academic construction, there have been a few other things such as a number of graduate level courses which have been granted funding by the State Natural Science Fund.

(3). The expansion, solidification and elevation of the corps of somatic science research has gradually put it on the right track. It has made comparatively good progress in organizational construction. After the establishment of the Chinese Society for the Somatic Sciences, what we are facing is several newly opened fields in somatic sciences. Paranormal functions naturally goes without saying, and although Qigong has been around since ancient times, it is still mainly passed from person to person. As for the fourth medicine, this is just starting out. Under such conditions, one problem will be unavoidable. The problem is the vast majority of our research forces have crossed over from other disciplines or are using spare time from the activities in their own disciplines to conduct research into somatic sciences. The directors of the first symposium of the Chinese Society for the Somatic Sciences, for example, should all have been full-time cadre dedicated to somatic science matters. However, of the 53 directors, only slightly more than ten were working full-time in somatic science. Most of the other directors were engaged in other work, and were engaged in somatic science in their spare time. I fear this situation will not be changed in the near future. However, a newly established field of science, if it cannot form its own corps of specialists, will necessarily be very restricted in its advancement. Faced with this reality, the task of organizational work will be very difficult. We have adopted a program of stable advancement which emphasizes quality. At the present time we have already grown into 245 individual members. Of these, 53.5 % are scientific and technical personnel at the level of associate professor or researcher or higher. The quality of this corps is relatively high, and in the future it should be gradually expanded, consolidated and improved.

(4). The serious attitudes our Chinese Society for the Somatic Science has maintained since its establishment has been further augmented and developed. This is also an aspect of the building up of forces which cannot be overlooked.

We have learned through practice that guidance by the philosophy of Marxism is not an abstract or empty thing, but is reflected in our attitude and behavior. This is emphasized in Marxism "practice is the only standard for truth." From the discovery of new phenomena to the proposal of new theories, we must have repeated practical testing. This demands one must maintain a serious scientific attitude, demeanor, and strictly use scientific methods. At the conclusion of the first symposium I stressed: "It is only in this manner our work can be placed in an invincible position." From the preparatory work

for this All-China symposium we can see this serious academic department has been improved and fostered. From the papers which will be read shortly, we will be able to see in order to confirm a newly discovered phenomenon, scientific research personnel must at times go for periods of years with repeated testing and verification and repeated deliberation to eliminate all the various factors that lead to false phenomena before making their judgement. If we use a certain method of conducting the experiment, for example, the use of laser spectrometer, then the data from the experiment must be first verified by experts in this area before it can be confirmed. I hope everyone continues to follow the spirit of the three "seriouses" in their participation of discussions in this symposium so our work will be able to stand the test of history.

The content of this All-China symposium will touch on a fairly wide spectrum of topics, and the work is also fairly deep-going and sound. In order to open this symposium, we want to propose a few ideas in principle for everyone to consider:

1. This is a solemn serious academic symposium. It is very difficult to organize such a conference. In order to completely exchange academic ideal and academic accomplishments so somatic science research can be put on the scientific track, and to promote advancements in somatic science, I hope everyone will conscientiously participate in the exchange and discussion according to the schedule arranged for the symposium.
2. Carry out the policy of let a hundred flowers bloom and a hundred schools of thought contend, and strive towards academic democracy and discuss the topics in a scientific manner.
3. Keep the level of the symposium at the high level stipulated by the spirit of the series of central documents.

The preparatory work for this symposium was determined by the standing board of directors at their meeting in Shanghai on 17 May where a symposium preparatory committee was formed. It received the active support of broad masses of somatic science workers throughout China, and has received 67 papers. There was a large number of people requesting to attend the symposium. Because of a number of reasons, the conference was limited in the number of people it could accommodate, so quite a few comrades were unable to attend. At this symposium, we will only invited a number of famous scholars in our field from foreign countries, and we received enthusiastic support from our counterparts in foreign countries, some who are in attendance and will give reports.

Since 02 November an Executive Secretariat has been established with four operations groups under it to carry out specific operations. Everyone also received the support of leaders at all levels and especially of Comrade Qian Xuelin, and also received the support and assistance of concerned which has eventually enabled us to convene this symposium. We express gratitude to these on the behalf of the Chinese Society for the Somatic Sciences.

I wish complete success to this symposium.

A PILGRIMAGE TO THE SECOND ACADEMIC SYMPOSIUM OF THE
CHINESE SOCIETY FOR THE SOMATIC SCIENCES

BY: Xin Zhu



ILLUSTRATION ONE; FIRST MEETING OF THE THIRD BOARD OF GOVERNORS

From 13 to 17 November, 1989, the Chinese Society for the Somatic Sciences held its second All-China Academic Symposium in Beijing. Delegates from all over China and friends invited from Japan and the United States attended, totalling 233 persons.

On 14 November, the symposium held its opening ceremonies. The vice president of the society, Comrade He Chongyan presided over the symposium and welcomed the delegates from China and from foreign countries on behalf of the Society. President Zhang Zhenyuan summarized the study and experiences, and the further determination of the philosophy of Marxism as the leading ideology since the founding of the society. He summed up the application of the advanced accomplishments of modern science and technology and the absorbing of the essence of China's ancient culture and the dedicated spirit of those working on the field of somatic science. These are the basic guarantees of the success in somatic science endeavors in China. With several years of hard work, there has been several gratifying achievements in academic construction in somatic sciences, and furthermore, the research corps in somatic sciences is gradually being expanded, consolidated and improved. A fair amount of progress has also been made in organizational construction. At the present time the society has already grown to 245 members, and as many as 53.5 percent of the members are research workers with high level positions. Such a high quality corps is not a simple thing. The serious academic attitude adopted by the Chinese Society for the Somatic Sciences since its preparatory days has been further perfected and fostered in these past few years, and president Zhang Zhenyuan's speech was a great encouragement to all the delegates.

Academic exchanges began on the 14th. The meetings were chaired by vice president Xu Lanxu and standing president Chen Shouliang. Those reading their papers were in order: Lin Shuhuang, Wang Zhongyuan, Wu Banghui, Chen Shouliang, Jia Jinding, Li Yushu, Wang Xiubi, Shao Laisheng, Zhang Zuqi, Song Kongzhi, Lu Zuming, and Liu Yi. They each introduced the subjects of their

work, which were of many different types and which the delegates found very interesting. In order that the many different papers and subjects which required in-depth discussion be fully developed, on the afternoon of the 15th, the symposium also organized three small groups for exchange. Those attending the conference were very interested in the paper by Comrade Huang Jinggen and others entitled "Exploration into the Force in Paranormal Writing, "The Paranormal Two Way Effect in Somatic Science" by Luo Xin and others, "The Screen Effect" by Shao Laisheng and Zhu Yiyi, "Old Qigong Master Qie Gushi" by Chen Taoqiu, "The Paranormal Functions and Earthquake Prediction" by Tao Zhangyuan, "Brain and Heart Coordination in Achieving the Qigong Dominant State" by Wang Dekun, "The Science of Qigong and the Perfection of Self" by Wang Wu'ai, "High Speed Photography of Breaking Through Spacial Barriers" by Zhao Ximing and others, and "Research into the Abnormal Effects of Paranormal Functions" by Zhu Nianlin and others. Exchange was conducted at the symposium on the following papers: Japanese Contributions to Somatic Sciences" by Japanese scholar Tangqian Taixiong, "Use of New European and American Theories to Investigate the Movement of Objects" by Shi Tengyuan, "Qigong and Parapsychology - a Comparison of Research Trends in Japan, China and the United States - Concerning Altered States of Consciousness" by Jin Cunjiao, and "Welcoming the Arrival of the Age of Psychosomatic Physics" by American Scholar Li Ruimu. Mr Zuo Zuomu from Japan delivered his "Electrical Measurement of the Interrelationship Between the Qigong Master and the Receiver" at a small meeting, generating excitement among his counterparts. He reported the results of experiments he had conducted duplicating experiments done by scientific and technical workers in China had conducted on Qigong, and also very sincerely discussed with his Chinese counterparts developments in material selection and other matters.

On the evening of the 15th, at the request of the delegates, Wang Youcheng and Zhang Baosheng gave demonstrations of moving coins with paranormal functions, mental telepathy, using paranormal functions for setting clothing on fire, breaking through spacial barriers and recognizing characters that amazed many of the comrades who had never personally observed such acts. The chairman of the Biology Department of the State Natural Science Foundation, Professor Sheng Zujia, personally served as a subject.

The closing ceremony of the symposium was conducted on the afternoon of the 17th. In was presided over by the Secretary General, Comrade Zhu Runlong. Deputy Standing President Chen Xin gave the concluding address. Comrade Chen Xin confirmed the success achieved by this academic symposium and very proudly stated to the comrades from the viewpoint of the papers presented at this academic symposium, we have made outstanding accomplishments in our work in the field of somatic science, and we stand at the forefront of the world in this area. This is something to be proud of. All the foreign friends attending the symposium enthusiastically applauded showing their approval. American Chinese Li Ruimu could not restrain himself from standing and applauding, showing his pride in being Chinese. Comrade Chen Xin summed up the symposium in the few words: "very successful, very productive, very enthusiastic, very solemn and very serious." He also elaborated somewhat on this. Comrade Chen Xin

emphasized five basic points in developing research in somatic sciences: ① It is necessary to firmly establish the concept of the human body as an open, complex giant-scale system. ② The question of methodology is studying this open, complex giant-scale system. ③ We must continue to probe deeper into our research into phenomenological questions. ④ The determinant and non-determinant questions in somatic science. ⑤ Qigong is a stepping stone to success in somatic science, and electromagnetic waves may be a clue, but they are not the basic nature. Comrade Chen Xin expressed his hopes that the workers in somatic science would strive to improve their own scientific levels, and continue to expand their own areas of knowledge, that they would give full play the greatest intelligence of the Chinese people and dedicate themselves to science. That they would overcome all obstacles, triumph over all interference, and unit to further advance the study of somatic science. Chairman of the Biology Department of the Natural Science Foundation, professor Sheng Zujia took part in the symposium throughout the agenda and took part in the team meetings. At the closing ceremonies he talked about his impressions of the symposium and was greatly inspiring to those attending the symposium. China's famous scientists, professors Zhao Zhongshao and Yang Longsheng and the former secretary of the Secretariat of the China Committee on Scientific Cooperation, Comrade Nie Chunrong all attended the symposium and the group discussions. Finally, Secretary General, Zhu Runlong, relayed the wishes of one central responsible comrade for the successful symposium. He also enthusiastically quoted a line from a poem by Xue Lai, "Winter is here, can Spring be far behind?" to wish the early arrival of the Spring of somatic science. The symposium victoriously concluded amidst enthusiastic applause.

After the closing ceremonies, the Sichuan Educational Press held initial release ceremonies for the FOUNDING OF SOMATIC SCIENCE (first edition). The initial release ceremony was chaired by the standing director, Comrade Ye Zhaogi. President Pu of The Sichuan Educational Press expressed the willingness of the Sichuan Educational press to make some substantial contribution to China's somatic science endeavors, causing the delegates to feel deeply moved. Vice president He Chongyan expressed enthusiastic congratulations on the release of the book on behalf of the Chinese Society for the Somatic Sciences. He also introduced the delegates on some of the special character of the book. The Editor in Chief of this book, Zhu Runlong, on his own behalf and that of the two Zhu's, expounded on the process of compiling and selecting articles for this book and the strenuous efforts it took. He also expressed their gratitude to Comrade Qian Xuelin and the other comrades who wrote the other papers comprising the selections in the book. He expressed his heartfelt wishes to the delegates of the symposium and the foreign friends there on behalf of the two Zhu's. The Central Television Station and the New China News Agency and other press units reported the news of this occasion.

During the symposium, the third session of the original board of governors was also convened. It was presided over by president Zhang Zhenhuan. Vice standing president Chen Xin presented a report to the entire board on the Society activities of the past year. He presented some ideas for work in 1990. The advisors and board members attending the session engaged in enthusiastic

discussion over these topics. Hoping the Society would give full play to the forces in all areas to develop Society activities. The following decisions were made at the session.

1. The fourth session (a plenum) of the original board of governors of the Chinese Society for the Somatic Sciences would meet in the first half of 1990 (date and time to be notified later) to study how well the 1990 operational plan was being fulfilled and for future ideas.

2. It was planned to convene an international conference on somatic studies in 1991. At the present time, work would begin on preparing a highly qualified team to take six months time to conduct investigation and research and then to demonstrate the possibilities. The organizational system will be coordinated with the National Defense Industries Commission and will be the responsibility of Standing Committee President, comrade Lin Shuhuang.

3. It was approved that the editorial committee for THE CHINESE JOURNAL OF SOMATIC SCIENCE be formally established with Comrades Zhang Zhenhuan, He Chongyan, Zhao zhongshao, Bei Shizhang, and Yang Longsheng as advisors to the editorial committee, with Chen Xin as the chairman of the editorial committee, with Zhu Runlong, Chen Shouliang, and Xu Lanxu as vice chairmen of the editorial committee and with Chen Xin, Zhu Runlong, Zhu Yiyi, Luo Xin, Fang Linhu, Lin Shuhuang, Chen Shouliang, Wang Xiubi and Xu Lanxu as the nine members of the committee. This editorial committee would be the organ providing direction for Society publications. At the same time it approved the editorial department as its operational organ, with Zhu Runlong as the editor in chief, Zhu Yiyi as the associate editor in chief, and Yang Xueqi and Lu Yincheng as editors. The initial issue was to be published in 1990, and it is to be a quarterly in following years to be circulated in China and abroad.

4. It was approved that the society's second level organ, the "editorial, translation and publishing committee" be formally established. Zhu Runlong was to be chairman of this committee and Zhu Yiyi, Chen Shouliang and Xu Lanxu were to be vice chairmen. Depending on the operational requirements, this committee man hire a small professional staff as committee members and operational personnel. The editorial, translation and publication committee should, depending on somatic science advances in China and abroad and actual requirements of the readers, edit, translate and publish papers, materials and theses concerning somatic science.

5. Recommend that the various localities convene academic convention conference on special areas.

6. Improve the establishment of the specialty committee, which is to clarify through discussion the scope of contents of the various disciplines and to draft an operational plan.

7. Approve the NEWSLETTER OF THE CHINESE SOCIETY FOR THE SOMATIC SCIENCES as the internal publication of the society (monthly publication) with Liang

Baolin, Wen Zongyuan, and Yang Xueqi as the editorial group to publish the newsletter on schedule. In order to do a good job in running the newsletter, several journalists will be hired at the provinces, municipalities and autonomous regions which have already established Somatic Science Societies or research societies as well as the graduate student classes at universities to form communique networks and to provide manuscripts for the newsletter.

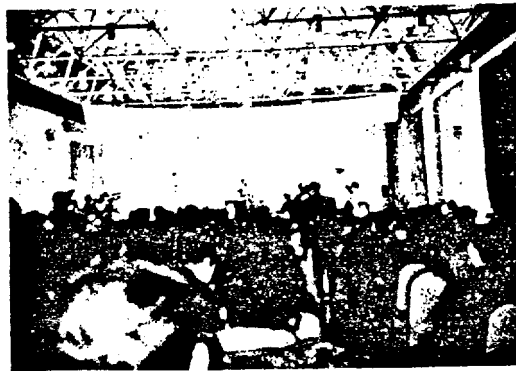

ILLUSTRATION TWO: INITIAL RELEASE CEREMONY FOR THE BOOK
THE FOUNDING OF SOMATIC SCIENCE

A GRAND MANKIND ENGINEERING PROJECT STARTING A NEW ERA OF HISTORY

REVIEW OF FOUNDING OF SOMATIC SCIENCE

Written by famous scientist Qian Xuelin and others and edited by Zhu Runlong and Zhu Yiyi, the first volume of the book FOUNDING OF SOMATIC SCIENCE published by the Sichuan Educational press faithfully records the work in the earliest stages of the founding of somatic science. It is a combination of theory and practice, it is strong academically and in material, it is a major scientific work with far reaching influence. The publication of this book is a major event in the history of science and technology. Its significance cannot be underestimated.

"Somatic Science", this brand new concept, was proposed by Comrade Qian Xuelin early in 1981. What he was referring to was a scientific system outside of the three major sciences of a mathematical science, natural science and social science. A brand new discipline which was just forming. It was a science to study the functions of the human body. The new field of somatic science attracted a large number of famous older generation scientists in China such as Qian Xuelin, Zhao Zhongshao, Wang Jinchang, Bei Shizhang and others. It also attracted the attention of people in all fields. More and more scientific and technical workers and comrades from other fields enthusiastically entered this work. In the past ten years, there have been rapid advances in somatic science in China. It has enjoyed several gratifying accomplishments. It has struck a resonant chord in China and abroad. The collection of articles in the first volume of FOUNDING OF SOMATIC SCIENCE illustrates the great successes scored by somatic science research in China over the last ten years. It is an overall summary of the development of this work in China. This book collects articles covering a period beginning in May of 1978 with the publication of the first scientific research report in China concerning the physical nature of Qigong external air and the article published in the 11 March, 1979, "Sichuan Daily" concerning a child in Dazu County who could recognize characters by use of his ears. The inclusive articles includes various major theories and explorations on such subjects as Qigong, somatic paranormal functions and research in Chinese medicine, summarizations, descriptions and critiques and empirical research, totalling more than 600,000 words. Its summarization is extremely thorough, systematic and timely. In these article, the theoretical portion thoroughly expounds on the terminology, nature, positions, missions and subjects of research, categories and methods, and the connection between these and other sciences nd departments. It basically collected all of Comrade Qian Xuelin's relevant discussions up to the present time. The experiment portion is divided into a collection of the results and analysis of the data from various typical experiments in China since experiments in somatic science were begun. These include Qigong research and somatic paranormal functions research. The later is further divided into such special topics as paranormal perception, paranormal kineses, paranormal writing, and paranormal radiation. This book is the first one especially written in this field. Its timely publicizing of these accomplishments will

undoubtedly play a major role in promoting further developments in somatic science. The advent of this book not signifies that research work in somatic science in China has already made it though the earliest difficulties, but also presages that this work is about to enter a new profound stage of research.

This book has a fairly sizeable breadth and depth both in theoretical exploration and in empirical research. This is especially true of some major discourses by Comrade Qian Xuelin. Not only are they of important significance providing direction for somatic science itself, but for other scientific fields as well. For example, in theory it proposes the use of dialectical materialism as a guide for research in somatic science research, uses the man-universe concept as the bridge from somatic science to the philosophy of Marxism, and establishes the doctrine of somatic functional states. For the establishment of research methods in experiments, its investigation into the validity of the existence of somatic paranormal functions and how widespread they are, its investigations into the mechanisms of Qigong and somatic paranormal functions using various methods, and research into these functional phenomena and their natures - all of this, has an undeniable significance for constructing the framework and direction for the research in somatic science. Its academic value also lies here.

Comrade Qian Xuelin points out: "The deep-going research into somatic will necessarily completely alter the knowledge of mankind and will improve the power of nature. It will be a benefit to mankind." "This can lead to a new scientific revolution in the 21st century, which may be an even greater scientific revolution than that of quantum mechanics and the theory of relativity early in the 20th century." "It will definitely lead to a second cultural renaissance and is another flying leap in the history of mankind." Without a doubt, the creation of somatic science - this is a history making future creating, grand engineering project of mankind. These original records which reflect the construction of the historical foundation are complete and systematic scientific and technical historical materials. They will definitely occupy a space in the history of science and technology.



ILLUSTRATION 1. EDITORS-IN-CHIEF OF THE BOOK "FOUNDING OF SOMATIC SCIENCE", ZHU RUNLONG AND ZHU YIYI THANK THEIR COMRADES FOR THEIR DEVOTED COOPERATION.

This book is valuable as historical material, in addition to the complete and systematic records, and the many successes reflected which are typical and representative, the more than one hundred photographs and illustrations, graphs and original data are also very valuable scientific and technical material, especially the several groups of high speed photography of somatic paranormal functions shown frame by frame which faithfully recorded those very significant results of scientific experiments, which are of very high scientific and technical value.

Naturally, the public publishing of this material is not without significance for popularizing somatic science knowledge, removing the various ignorant superstitious ideas, letting people properly know about their own bodies, and striving for an overall beginning in somatic functions. The serious and faithful recording and relating of the work of the scientific and technical personnel, will undoubtedly illustrate their scientific achievements to the world. This in itself is a very serious undertaking. Practice is the only yardstick of truth. This ideology runs throughout the entire volume. It is convincing. It may also be considered to be one of the major distinguishing features of the book.

Another distinguishing feature of the book is the rational combination of theory and practice. Theory is proposition and practice is the proof. Search for new theories on the basis of scientific experiments which, on the other hand, give direction to new experiments. This book provides such examples. In form, this book is divided into the two major portions of theory and practice and is basically arranged in date order. This naturally was in order to facilitate the categorizing and reading of the material, but by reading closely, one can discover that there is a close inherent relationship, in which one confirms, supports and infers from another. Just as Comrade Qian Xuelin has emphasized, we must use dialectical materialism to guide our research in somatic science. The combining of theory and practice is perfectly in line with this spirit. Actually, not only is this so, but it should be said that the entire book reflects the guiding ideology of Marxism. Space limitations of this article keep me from further analysis.

ILLUSTRATION TWO: PRESIDENT PU OF THE SICHUAN EDUCATIONAL PRESS
INTRODUCING THE BOOK TO THE DELEGATES OF THE SYMPOSIUM



The editors-in-chief of this book, Comrades Zhu Runlong and Zhu Yiyi were the first scientific workers in china to organize and conduct somatic science experiments. Not only have they put their hearts into the development of somatic science in China and have an emotional investment in this enterprise, they also have a profound understanding of research in this area. Therefore, the editors notes they have written to proceed each chapter provides the reader with the background, position and significance of the chapter, undoubtedly making it easier for the reader to follow the developments in research into Chinese somatic science. This form of editor notes is also one of the distinguishing characteristics of this book.

What we now have is the first volume of FOUNDING SOMATIC SCIENCE. However, we hope the second, third, and further volumes will quickly come out. We hope that this work which has already begun will become even more grand and glorious.

SOVIET STUDIES OF THE HUMAN ABILITY OF SUPER-PERCEPTION

TRANSLATED BY: Li Huang

"Science and Life", a Soviet monthly magazine with a circulation of 3.4 million, in a recent issue published a lengthy major article on the study of the question of the human ability of super-perception. The human ability of super-perception is about the same as what we know as the somatic paranormal abilities. However, it also seems to include certain aspects of QIGONG [transcendental meditation]. According to the introduction, it is in the early stage of development, and there are heated debates over the controversy. This article will briefly introduce the topic. It would be somewhat unusual to publish a lengthy article in this issue, so a brief introduction follows.

Several years ago, there appeared in a number of publications in the Soviet Union a large number of reports of a super-sensitive (one who is a master of super-perception) who had amazing abilities to diagnose and treat various types of illnesses. Many of the authors pointed out that the super-sensitive can guess the state of the body, and can quickly and accurately determine the illnesses with results better than doctors using various types of instruments and equipment and biochemical examinations. Furthermore, the only tools the supersensitive uses are his own hands. During his examination, the super-sensitive does not need to touch the patient, but need only carefully "feel" the biological field with his hands a few centimeters from the skin of the patient. The patient need not disrobe. Then, depending on the characteristics of the patients biological field, he proceeds with his diagnosis. Actually, he can recognize all types of illnesses which are already known immediately, from spinal meningitis to duodenal ulcers to geriatric hardening of the arteries. As his super-sensitive abilities have improved, he has come to have super human abilities to cure ailments. The super-sensitive still waves both his hands and uses his own strong biological field to act on the patient. After several times, even if the patient is not completely cured of any ailment, he can reduce various symptoms to some degree.

Since the publication of the reports of super-sensitive abilities, a large number of readers began flocking to the editorial department of the publications, asking all sorts of questions which the editorial department could not answer. The editorial department sent a special reporter from its own publication to investigate the matter and to interview the super-sensitive. The reporter's assignment was first of all to learn everything possible from the super-sensitive with power over the biological field and the patients he had cured, to learn many details, and to listen to all types of contrary opinions and evaluations from specialists. He was also to locate and carefully read the many different articles already published. The following is the special reporter describing his assignment in the first person.

I found this assignment strongly attractive. Also, not long ago a great deal of hope arose concerning the clarification of the basic key elements of

"super-sensitive abilities". This anticipation was based on the combination of work done in laboratories under the direction of academician YURI WAXILIYEVICH GULIYAYEV [phonetic] and physicist mathematician Doctor ADEHUA AİMANUYINLEVICH GEJİKE [phonetic]. Here I will talk about the results of their research and my impression and thoughts during my interview. The revelation of the truth of super-sensitive abilities also began gradually. It was very interesting.

We sat in an old style MOSCOW brand automobile, setting out at four in the morning from the sleeping capital and never stopping. In the early evening we arrived at BULIESİKE [phonetic] more than 1,000 kilometers away. We did not stop over in the city, but proceeded directly to the border defense traffic inspection station. It was another 200 kilometers from there to Warsaw. We wanted to hurry up and get there to take part in the international science and technology symposium. It looked like we would have no problem getting there on time. After we arrived at the border defense inspection station, we had to sign exit cards and show our papers. Before long, we would be notified that three of us were permitted to leave the country, but one of us was not allowed to leave because the expiration date on his papers was not clear. What could we do. We did our best to come up with some way to solve this problem. At first we dealt with a young duty First Lieutenant, later with the ranking officer of the border defense inspection station. The people we made contact with were all extremely likeable and expressed their sympathy. They were willing to stretch the rules and make concessions as far as their individual affairs were concerned, but they resolutely refused to act in violation of regulations concerning crossing the border. Therefore, there was nothing else we could do, and the other person flew back to Moscow early the next day to get the necessary papers stamped and returned to BULİESKE that night. As a result, we were a day late in arriving at Warsaw. By this time, the incident at the border inspection station was all but forgotten. However, we had learned a lesson and an important principle. In the words of the first lieutenant: "all border inspection stations have to make a check. We cannot violate this principle." This is true. Super-sensitive abilities have to be inspected using science and technology before it is released; before it will be accepted by the people and finally widely used by them.

(The following excerpts of conversations come from my notes of my conversation with academician GULIYAYEV [phonetic] deputy director of the Soviet academy of Sciences Radio Technology and Electronics Institute and director of the Radio Electronics Remote Sensing Methods Graduate Body Laboratory.)

"Construction of the laboratory began in 1962. As time went on, it caught up with the so-called period of intense interest in super-sensitive abilities. Because of the great interest of the broad masses, I should explain a few things to convince them. As for the rumors concerning the mysterious "diagnosis" and "curing", there is basically no objective informational data. Therefore, we have decided to use precision methods of physics and radio electronics to conduct a thoroughgoing research and we hope that we can clarify

and disclose whether or not there is any element of this theory which coincides with the principles of physics."

"Have you come to any understanding"

"More on that later. Now I should point out that paranormal and supernatural are only fragments. The primary studies of each of the research groups were all different. For example, a long time ago we began serious study of just exactly what type of physical field surrounded the human body, in what forms did it manifest itself, how could it be used to collect information for biological research and in applied in medical practice. We came up against two problems in forming a study team at the radio technology and electronics lab. The first was that the laboratory had traditionally concentrated on biological and medical topics. All we had to do was mention the huge cycle of the research work directed by the academician NIGULA DEMITELIYEWI IQI JIEWEITEKE [phonetic], the items they studied were mutual effects of radio waves (primarily super high frequency) and biological factors. Second, the institute placed most of its energies on remote sensing research. For example, by radio sensor of Venus in the beginning until later when we were able to use radio methods to locate ore. Naturally, this is a different type of problem. However, there were a number of common points between them. Once we started, we concentrated on seven channels for transmitting different types of information. (1), surface infrared radiation. (2), Radio radiation which could reflect the temperature of internal organs. (3) Electronic fields. (4) Magnetic fields. (5) Chemical luminescence (luminescence outside the skin within the light wave parameters). (6) Sound waves. (7) Chemical compounds emitted through the skin in the form of evaporation. We have conducted research on most of these channels. Some have even been used in clinical diagnosis. However, we still decided to start from scratch and do an exhausting new study with a strictly scientific attitude, and we have had a number of encouraging successes, especially thermoscopy, which has not only created new possibilities in the study of skin blood circulation, but has created new possibilities in brain research. Through the study of minute changes in the mechanism of heat exchange in the skin, many new things may be discovered."

"Does your plan include study of persons with super-sensitive abilities? And if so, how can you test for these abilities?"

"First of all, the word "super" may not be appropriate here. Whether it is one of the seven channels I mentioned earlier or if it is a different nature of thing than the general abilities of most people which no one can detect, the heat radiation from the hand is enough to be detected by others. as for whether or not it is possible to use this type of energy for diagnosis or treatment, you should not ask us, but you should go ask a doctor. Of course this question should not be considered independently at some public academic symposium, but this question should be answered by arranging clinical experiments, and find out if it is of benefit to the doctors, because the hands are natural thermometers and the hands are natural warmers. I should emphasize, that I am only talking about doctors and professional super-

sensitive. As I see it, if it were done by an outsider, even a harmless massage could result in a great deal of discomfort. I really regret that our Ministry of Public Health did not research this, but allowed it to be turned over to non-specialists to mess it up."

In order to remind everyone of the excitement surrounding the "mysterious biological field" a few years ago, I am going to take a few extracts from publications of that time and talk about them or cite abstracts. This material is only presented for the reader to think about. It is only hearsay, and as for how to explain it, that is entirely up to the reader himself.

"The plant which can detect evidence of a crime is capable of transmitting extremely important information, but only a super-sensitive with a great deal of experience is able to perceive and decode this information."

"We have determined that when a super-sensitive is concentrating his thoughts, he can cause his biological field to intensify six fold."

"What kind of special reaction is this, is this your super-sensitive ability? This type of reaction has occurred many times, it is just called by different names, that is all. Furthermore, it is often embarrassing....

-- Yes, why don't I remember this.

-- and you should read about it. For example, 200 years ago all of Europe was astounded by the discoveries of Mesmer. He was the primary super-sensitive of that time. He was able to receive a special type of magnetism from the earth and because of this he was able to cure peoples' ailments. This kind of thing has been attested to by eye witnesses and patients who have been cured, the facts are there.

-- If there are people who say it is so, then it must mean that there is such a thing.

-- Here you go again with "what is it". The great LAVOISIER, a scientist who turned chemistry into a science through precise measurements, made a detailed study of the effectiveness of Mesmer's cures. Later he provided hard evidence that there was no effectiveness whatsoever. Do you know the difference between "hard evidence" and "everybody knows?"

"The brain can have the effect of a super conductor. For some people, they only have to concentrate and they can successfully establish a desired channel between their own bodies and an objective target. Once it is concentrated it is an intensified biological field. Under certain conditions, there was even ball lightning in such channels."

The following was extracted from my notes of talks with laboratory researchers, MATALASHAOFU [phonetic] who is head of the research team, and assistant professor of physics and mathematics GULAFUMIUFU [phonetic].

-- What we are studying is the question of a biological entity having a magnetic field. First of all as for the strength of the magnetic field, we remember that close to an iron magnet the strength of the magnetic field is about 100 oersted. The magnetic field of the earth is 0.5 oersted. The intensity of the magnetic field generated by living things is 10^{-8} oersted. Changes in the magnetic field can affect a series of functional processes of the living entity. It can have a clear effect on humans as well. However, with the human magnetic field so weak, it is very difficult to be detected or to be affected by another.

-- Are you following this line of research?

-- The entire world is conducting research. Several major cities in the Soviet Union such as Moscow, HAERKEFU [phonetic], TUOMUSIKE [phonetic], and DUBUNUO [phonetic] have all begun to conduct this kind of research and how biological magnetic fields assist in clearing up important details in the biological processes. At the same time it is providing new possibilities in medical diagnosis.

-- What can be learned from a doctor analyzing a person's magnetic field? Also, how are these magnetic fields generally produced.

Normally, the magnetic field only occurs when a magnetic charge is in motion. The different magnetic signals in our bodies are caused by the ion current which occurs simultaneously with nerve impulses. As for magnetic diagnosis, well, at the present time the magnetic signal tapes can be used in studying the heart, brain and muscle signals. Our laboratory has already cooperated with the Soviet Union Academy of Medicine All-Soviet Heart Treatment Science Center in a joint study of the question of the weak magnetic field of the heart. One of our tasks is to accurately locate the focus of various disorders. This will assist in reasonable and effective treatment.

-- Do you mean say that you cannot use the extremely simple traditional methods such as EKG to locate the focus of disorders.

-- Currently new methods are required, because the traditional methods can only determine the general location of the disorder in the heart, and when modern medicine is conducting targeted treatment, it requires more accuracy. When traditional methods are recording the heart current, it receives interference from different currents from other tissue which can cause serious image distortion. However, it is a different story when using magnetic fields. The magnetic field is like the body is completely transparent. It does not generate any interference or distortion. Therefore, methods of recording the magnetic fields formed by the heart determine specific seats of disease with an error of no more than one millimeter. Prior to these methods, however, in order to record this type of magnetic field it was necessary to insert an electrode into the heart.

-- What is the difference between recording the magnetic field of the brain and recording the magnetic field of the heart?

- The major difficulty in studying the brain is that the brain magnetic signals are at a very low level (too weak). The intensity of recorded brain magnetic field intensity is only 10^{-9} oersted. This is only equal to one percent of the intensity of the magnetic field of the heart. Furthermore, it is extremely difficult to differentiate the extremely weak brain magnetic signals from interference several tens of thousands of times as strong. We are presently doing research on a type of new method called search and capture of brain magnetic fields. It is the use of sound, flashes of light and weak electric current to stimulate magnetic reaction from the brain. An even more important task is the study of structure of different regions of the brain and their operational sequence.

-- Is there interest in applied medicine toward studying the magnetic fields of the brain?

-- Of course there is interest. For basically the same reasons, the chart of the brain's magnetic field, just as the chart of the heart's magnetic field can precisely locate the seat of a disorder in the brain, and can do it much more accurately than traditional methods of using EEGs. Under many conditions, such as neurosurgery, a chart of the brain magnetic field is extremely important.

-- Does this mean that the recording of brain and heart magnetic fields will be adopted by clinical doctors?

-- Undoubtedly it will be used in various large hospitals. However, many complex problems must be resolved before they can be put to actual use, especially mass production of super conductor quantum interference (magnetic field) detectors and magnetic field intensity measuring devices. From the surface, this kind of precision instrument will basically be a super conductor loop, with one or two high level connecting apparatus (called JIAOZEFUSUONOFU contacts) [phonetic]. They will all need to be immersed in liquid helium. They would have the ability to detect the weakest of magnetic fields, as weak as 10^{-12} oersted. Therefore, it can actually be truly called an instrument with super-sensitive abilities. It will have super sensitivity, and obtain successful results in the study of human super-sensitive ability.

This brilliant creation will soon enter the realm of medical common treatment. I am afraid none of us can find suitable words to praise this type of modern medical new technology.

The following was extracted from my notes on talks during my visit with lab researcher and physicist and mathematician Assistant Doctor MIUXING [phonetic].

"We are beginning to study the always existing, more accurately the rarely changing, human body magnetic fields. We have completely entered another realm, we have entered the exhaustive study of several micromechanisms of control of body temperature. This is not a shift in interest. We were

searching for the electric power source for the body's magnetic fields and discovered that the electrical power source is on the skin. Thus, we should analyze its nature, and this unavoidably led to the study of the processes of body temperature control and heat transfer. The skin is a very complex biological living machine. It is a primary object of our long term research.

-- Both skin and heat control have been studied for dozens of years. Almost everything has been researched. Do you think that all the subtleties and minor details have been discovered?

-- However, when we start to take a close look, and conscientiously measure and use the philosophy of physics to evaluate and analyze, we will necessarily discover several significant and major details. At times we may even change the way we view the basic nature of some things. Thus, we want to make clear what is the cause that generates the change in the static potential on the surface of the human body.

-- Excuse me for interrupting, but I would like to know where the electrical charge comes from. Where does the body's magnetic field first appear?

-- The human body permanent static electric field has been known about for a long time and has been measured on many occasions. However, there are a number of different interpretations of this phenomenon. There are even people who believe that there are electrets - permanently magnetized electrovalent elements on our skin. Actually, because of the life in our bodies, it can cause the surface skin to have a weak potential of 0.05 volts, and the maximum potential may be as high as ten volts. For example, rubbing the back of the hand briskly several times can generate this result (friction generated electricity).

-- Can the use of this type of method to generate electricity generate much more than 10 volts?

- Normally not. The electrical field voltage at some spots may be higher, but sparks will occur at the high voltages, and this will restrict the increase of the potential. It is not important to know where the static electrical field on our bodies is generated. The important thing is what causes the static electric field and how is it quickly lost. In this process, the primary role is played by the subcutaneous layer of the skin which is only 40 microns thick. The subcutaneous layer is also an excellent insulating layer. After the surface generates electricity from friction, it becomes a unique capacitor. The subcutaneous layer is a dielectric. Furthermore, the lower skin has relatively good conductivity. The changes in potential are conducted throughout the body to create a magnetic field. If the subcutaneous layer generates free electric charge, then there is a "current". When a capacitor discharges, the static electric field is lost. Naturally, this is a macroscopic view, actually the so-called "current" is extremely weak, no more than a few hundred millionths of an ampere. Therefore, the change in the

potential on the external layer are also extremely slow, and it take several minutes to several tens of minutes to reduce it by half.

In the beginning, we carefully studied the nature of the subcutaneous layer. We measured the resistance to be between 10^{-9} and 10^{-12} ohms per square centimeter.

In order for the human body to adapt to changes in the outside temperature, it has two primary control systems. One of these is the sweat gland systems with which we are familiar. When it is hot, after the hypothalamus receives heat signals, it immediately orders the sweat glands to secrete perspiration through the skin. The perspiration continuously evaporates and carries the heat away. The other system is the cold prevention system. When the weather is very cold, the hypothalamus issues orders to speed up blood circulation and intensify biochemical reaction processes to ensure the energy supply. Finally, it even uses shivering methods to alter the heating mechanism. In addition, the skin also has small systems which function independently in some areas. At 0.5 mm below the surface of the skin, there is a network of capillaries. The dilation or contraction of these capillaries is a primary factor which directly functions to regulate the body temperature. It is responsible for one-third of the heat dissipation.

-- Is a great deal of water evaporated through our skin?

-- An adult will perspire 50 grams over a 24 hour period without realizing it. During heavy perspiration, a liter or more can be lost every hour. The area automatic temperature regulating systems can only function within a small range of outside temperatures. For example in a room with a temperature of around 20 degrees Celsius, its operations can reflect a number of important signals such as the blood supply, blood vessel state, the degree of activity in a series of biochemical reaction processes. Furthermore it not only reflects the area epidermis situation, but it can also reflect the situation with certain internal organs. Thus, we need only measure the intensity of perspiration of one piece of skin and we can determine the change in the electric field in the area as well as the blood supply situation in the area. This is the overall situation. At the same time this research can also show changes in interesting biological mechanisms and numerical contrasting relationships.

-- Are there remote sensing methods?

-- When an electrical field exists, it is possible to detect this at a certain distance. The faster the electrical field disappears, the stronger the conductivity of the surface layer of the skin. The more charge lost, then the more rapidly the water is transported. Naturally, it is only with electrical methods that it is possible to measure the thermosensitivity of the skin. It appears that the skin thermosensitivity is very high, about 0.1 milliwatt/square centimeter. That is to say, the skin can feel the heat from a burning match at a distance of one meter.

-- You stated that unnoticed perspiration intensity could reflect the state of internal organs, how could it reflect this?

-- A certain functional relationship exists between some internal organs and specific areas of skin through the central nervous system. This area is called the ZHAHALIN - GEDA connection region from the name of the person who first discovered the relationship. He published his discovery of this phenomenon at the end of the last century. In medical papers it is sometimes called the dermatome. The next step is to study why this kind of phenomenon exists from the concepts of the theory of evolution. At times the internal organ will be on one side while the corresponding skin connection region is on the other side of the body. At the present time, the dermatomes have already become diagnostic and even treatment windows for internal organs.

-- How does this work?

-- The live body is an extremely complex system. The connections between each link is very perfect and detailed. Furthermore, there are many kinds of structures. Therefore, in answer to your question I can only select one of the many situations that exist. I have decided to chose the thermal function of the skin ZHAHALIN - GEDA connecting area, to see to what degree it affects the activities of the corresponding internal organs.

-- Is the path toward diagnosis and treatment?

-- It is still a long ways from the research successes we have described above to providing actual treatment. There is still much yet to be done. For example, there are measurements, research, and conscientious investigation. Such an important matter should be completely understood, but this has not yet been achieved.

-- Is it currently permitted to treat people through thermal (energy) channels? Just how much heat radiated energy is there in the human hands?

-- The human heat radiation power averages about 100 watts.

-- Is this enough to light a large light bulb?

-- Yes, it is. However, the 100 watts is disperse all over the entire area of the body. About 0.1 watt or 100 milliwatts goes to the hands. Naturally, this energy cannot be considered small. Under various conditions, the skin can feel the heat of the hands from a distance of 20 to 30 centimeters. Actually, the thermosensitivity of the skin is very high. This includes the two hands. They can detect changes in the temperature within 0.3 degrees at close range.

It is very possible that super-sensitive persons collect and make use of patient information and treat the patient based on these heat (energy) channels.

-- What functions would there be, but this still does not mean that treatment

The following extracts are from articles and comments from publications and are provided for the reader's information.

"Some people believe that images and thoughts can both be transmitted long distances. This is not the case. Actually, the only thing that is transmitted is the biological field transmitted by the patients subconscious while the super sensitive is working."

"Why do you doctors still find it impossible to recognize and do not dare to say whether or not you can treat disorders of the biological field?"

-- Why would we want to do research on that witchcraft. I do not have the time. I have to see 30 patients every day.

-- You should find the time. Because this so-called witchcraft has attracted the attention of millions of people, and except for you, no-one else is able to clarify it."

This is what that person does. He stretches out both hands to within 15 to 20 centimeters of shriveled green leaves, and it looks like he is going to inject new life into dead cells. After several minutes, the leaves begin to shine, and have been restored to life."

"I want to emphasize like an expert that acupuncture is far from being an effective universal treatment for every kind of ailment. In the past, it was widely used in many countries in the Orient. This illustrates that at that time it was the only method of treatment that could be accepted (afforded) by the masses."

"We have some bean seeds that have been radiated with human animal magnetism. These seeds grow into good seedlings and plant stalks, and produce twice as much as ordinary beans."

"We not only believe, but actually know that biological fields can cure. A super sensitive held the palm of his hand on my temple for five minutes, and with the effect of his biological field my headache was gone. Do you understand? Completely gone.

-- This could be the "placebo" affect.

-- What does that mean?

-- In experiments we gave patients ANNAIJIN [phonetic] and their headache was gone. But the ANNAIJIN tablets were not the real thing. There was no medicine in them. This was only a type of placebo effect. This type of curative effect does not come from the chemicals, but comes totally from autosuggestion. This is a totally psychological cure.

-- What is the difference. Where does the result come from. I really know the headache is gone, and this is the most important thing.

-- At such times there is no need to stress this type of energy, you were cured by biological field..."

"You speak of the term biological field so loosely, just what is the "biological field"?"

- This is a kind of special somewhat magical material phenomenon, it only exists in living bodies...

-- Then, can you devise a means to objectively record, measure and reveal its physical properties?

-- Do you physicists study this type of material phenomenon? We are not interested in more details. Our business is philosophical concepts, expression and recognition..."

"I do not have any factual basis for expressing my approval, but I believe, believe, believe in the biological field...."

-- Please believe that we have the freedom to believe..."

"You are an arrogant stupid ass. You have already undergone numerous severe attacks. What does quantum mechanics count for. You have not learned your lesson. Did you think that all the animals in the world were as simple as you."

"I never thought about it before, but I am prepared to accept ESP, I am prepared to accept telekinesis, I am prepared to accept precognition. But only if you can show me investigative evidence, only if you can explain the sequence of testing. I cannot believe that any words, any sound can affect object reality."

We can reach a simple conclusion from what was said above. Biological bodies do not contain any special mysterious matter which people have been talking about. However, biological bodies do contain certain basic physical fields which have been recorded. Also, these weak basic physical fields of the human body have been studied. These physical fields include: magnetic fields, sound fields, radio radiation fields, etc. Very significant information can be gained from them. On this basis there have been new diagnostic methods generated and research into their use in treatment. Naturally it is still necessary to have them go through scientific examination. We believe that hypothesis will become reality. Super sensitive ability will eventually become the most effective method of treatment in the hands of the doctors.

Translated by Li Huang (from Russian) "Science and Life" 1987 Issue One.

READERS GUIDE

THE CHINESE JOURNAL OF SOMATIC SCIENCE is now in print. The editorial department of this magazine will write this "readers guide" for each issue. Here, the word "guide" in no way means instruct, but more like a tourist type guide. In a travel agency, a "guide" is a basic worker, but is a very important worker. In addition to making arrangements for the meals, lodging and accommodations for the tourists, the tourist guide will be primarily responsible for the selection of the scenic sites as well as explaining the local customs, ancient ruins, and history. Because the guide has seen the sites before the tourists, so these introductions will be very helpful to the first time tourist. Therefore, we editorial personnel, in getting to know the readers, and in the process of examining the submitted drafts, also see the manuscripts before the readers. There are all types of articles, so we will write our true impressions of these articles in this "readers guide" - this is in no way an attempt to influence the reader or to embellish the articles. Naturally, a article will give different impressions to persons viewing it from different angles. This magazine is not trying to impress anyone. Just as there are advantages and disadvantages to tourist guides, so are there advantages and disadvantages to this "readers guide". As for what form this "guiding" will take, it will not be our own selection, but will be decided by the readers.

The initial article in this magazine, "Somatic Science - An Important Frontier Leading to Breakthroughs in Modern Science", was selected and written by the Chinese Society for the Somatic Sciences. This article is like a manifesto. It is the personal experience of those working in somatic science in China through ten years of arduous exploration, research and struggle paid for with their own sweat and blood. It is about the creation of the new science of somatic science, and it gives their viewpoints on a subject difficult for many people around the world to accept, the somatic paranormal functions. A draft of this article was requested by the former HONGQI magazine press in 1988, and was published in the SEARCH FOR TRUTH magazine in its "Internal Manuscripts" department in its April 1990 issue. It was written by an officer of the board of directors of the Chinese Society for the Somatic Sciences. It was reviewed and revised a number of times by responsible persons in the society.

Comrade Chen Xin's article "The Concept and Methodology of Human Body as an Open, Complex Giant-Scale System" is fairly large, nearly 20,000 characters. This is another important article how to study the open, complex giant-scale system of the human body following the publication of Comrade Qian Xuelin's article "'Comprehensive Integration' - a Combination of the Quantitative and the Qualitative" as the method of research to be used in the study of the open, complex giant-scale systems in the January issue of NATURE magazine. It is also a response to Comrade Qian Xuelin's article. The founding of a new field of study will necessarily be accompanied by the establishment of a new set of

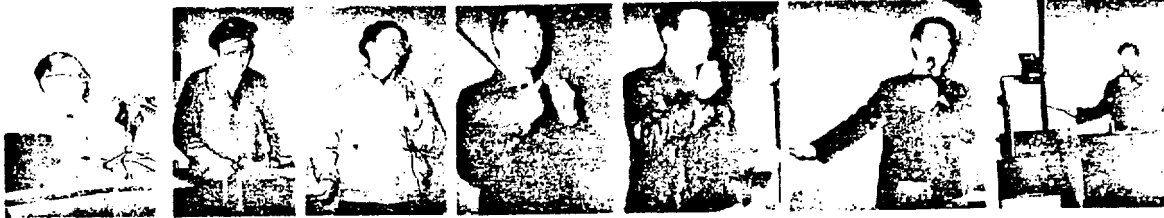

He Chongyan announcing
the opening of the symposium

Lin Shuhuang, Liu Yicheng, Song Kongzhi, Lu
Liuhu and Zhang Zuqi reading their papers



Chen Shouliang, Zuo Zuomu,
Jin Cunjian and Tangqian
Taixiong reading their papers

Group exchanges



Discussion meetings

Testing and observing Zhang Baosheng's paranormal
abilities



The older delegates

The Yunnan delegates

Chen Xin, standing vice president

the Shanghai delegation

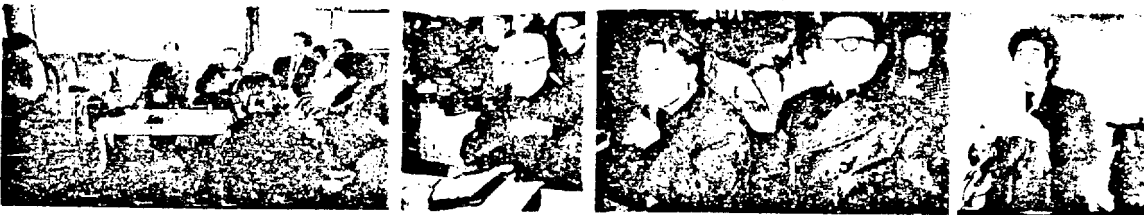

The press conference

Yang Longsheng

Gong Lisan and Wu Wenwu

Zhu Runlong announcing the conclusion of the symposium

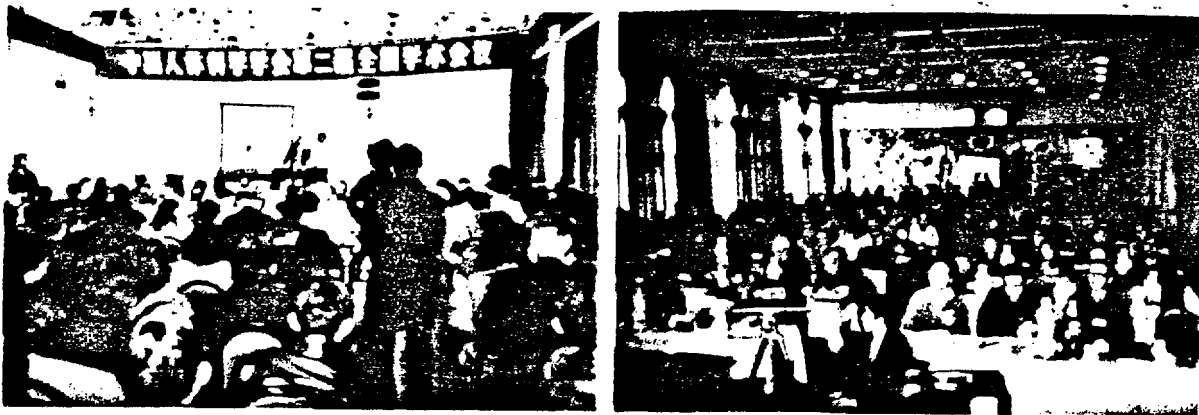

Panoramic view of the auditorium at the second all-China academic symposium of the Chinese Society for the Somatic Sciences



President Zhang Zhenhuan delivering the opening address



Sheng Zujia and Zhao Zhongshao



Nie Chunrong and Yang Longsheng accepted invitations to attend



Qian Xuelin holding intimate conversations with He Chongyan, Zhu Runlong and Zhu Yiyi



Foreign delegates at the symposium

EDITOR: Editorial department of the CHINESE JOURNAL OF SOMATIC SCIENCE
EDITOR IN CHIEF: Zhu Runlong
PUBLISHER: Shanghai Communications University Press
TYPE SETTER: Shanghai Hongqian High Speed Printing Company computer typeset
PRINTER: Shanghai Haifeng Printing Plant
DOMESTIC UNIFORM PUBLICATION NUMBER: CN31-1575 PRICE: 2.00 Yuan